

MERLYN IONIC



Your shower, your space™

THE IONIC COLLECTION | APRIL 2018



Contents

Introduction

02 The Merlyn Ionic Collection

Product

08 **Essence Frameless**
Frameless elegance

22 **Essence Framed**
Precision engineered

34 **Wetroom Panels**
Flexibility for your space

42 **Express**
The ultimate easy fit solution

54 **Source**
Affordable shower enclosures

61 **SecureSeal**
The ultimate leak-free bath screen

65 **Bath Screens**
Simple shapes

72 **TouchStone Trays**
Strong and durable

75 **Merlyn Upstand Tray**

Technical Section

77 **Product Information**

The Merlyn Ionic Collection

Your Shower, Your Space

The Merlyn Ionic Collection features an extensive range of shower enclosures, trays and bath screens to suit every bathroom and every budget.

We spent many years researching our customers, installers and plumbers in the UK and Ireland. From this research we developed a range that is stylish, innovative, fast and easy to fit. The Ionic collection pairs precision engineering with the highest quality standards.

This range offers fantastic choice and functionality, you can be sure to find an enclosure to suit your bathroom space and budget. From the contemporary frameless Essence to the framed classic Express this collection has been developed to meet the highest quality standards while maintaining a very stylish look and feel. Create your beautiful bathroom today by selecting a Merlyn Ionic shower enclosure.



Essence Frameless | Page 08

The IONIC flagship range



Essence Framed | Page 22

A range offering multi function and choice



Wetroom Panels | Page 34

Mix and match combination of shapes and sizes



Express | Page 42

The easiest fit system on the market



Source | Page 54

Excellence in design, durability and affordability



SecureSeal | Page 61

Leak free solution for baths



Bath Screens | Page 65

Contemporary screens that work with baths



TouchStone Trays | Page 72

Elegant low level installation trays



Upstand Trays | Page 75

Great value low level installation trays with upstand

Choose your Style

Products

	Shape	Essence Frameless	Essence Framed
Sliding Door	Rectangular	✓	✓
Quadrant Door	Curved	✓	✓
Hinged Door	Rectangular	✓	—
Pivot Door	Square	—	✓
Bifold Door	Square	—	—
Shower Wall/Walk In	Rectangular	—	—
Corner Entry	Square	—	—
Inline Panel	—	—	—
Bathscreen	—	—	—
Easy Fit System	—	—	—
Glass Thickness	—	8mm	8mm
Height	—	2000mm	1900mm
Guarantee	—	20 Years	20 Years



CE & EN Information

The CE marking on Ionic enclosures is a declaration that the product complies with the essential requirements of the relevant European health, safety and environmental protection legislation to EN Standards – EN14428. Confirmation of CE approval and Declaration of Performance (DOP) is available on our website: www.ionicbymerlyn.com.

For further information see Technical Section on page 76.

Wetrooms Panels	Express	Source	SecureSeal	Bath Screens
—	✓	✓	—	—
—	✓	✓	—	—
—	—	—	—	—
—	✓	✓	—	—
—	✓	✓	—	—
✓	—	—	—	—
—	—	—	—	—
—	✓	—	—	—
—	—	—	✓	✓
—	✓	✓	—	—
8mm	6mm	6mm	6mm	4, 6 & 8mm
2000mm	1900mm	1850mm	1500mm	1400-1500mm
20 Years	20 Years	5 Years	Lifetime	Lifetime



Mershield Stayclear

Merlyn treats products in the Ionic Collection with a special protective coating to ensure the glass maintains its sparkle. This comes as standard on Essence, Express, Wetroom Panels and most of our Bath Screen range.

Mershield Stayclear acts as a protective coating which when applied to glass, helps the glass to remain shiny and new without the need for tiresome cleaning. When cleaned correctly it helps prevent the build up of limescale and soap deposits making the shower glass "Easy to Clean". Please see tips for keeping the glass in pristine condition.

Without Mershield Stayclear Protective Coating

Without Mershield Stayclear protection water and soap deposits cling to the glass surface causing a build up of grime, requiring more vigorous cleaning.

Natural glass surface



With Mershield Stayclear Protective Coating

The Mershield Stayclear coating provides a larger contact angle for the water droplet on the surface and makes the drops smaller than drops falling on an untreated surface. This ensures the droplets roll away much faster down the surface, minimising deposits left behind.

Mershield Stayclear coating

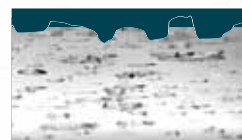

Mershield Stayclear coating creates a smooth layer over the surface of natural glass, lowering surface friction, making it easier for water, soap and lime deposits to run off the glass.

Tips on how to keep your glass in pristine condition

It is important to clean your glass after every use – wipe down with a soft cloth.

Install the enclosure in a well ventilated area.

Do not allow limescale to build up in hard water areas.

Ensure that any residual water on the glass is removed after every use.

Clean the glass regularly using soapy water.

DO NOT use abrasive products on any surfaces.

Keep up to date
with Ionic at
www.ionicbymerlyn.com



Join the Ionic Trade Club and make the most
of our great member benefits.

See the Express demo video online.

Find your nearest stockist.

Download our easy-to-use fitting instructions
and technical information.

Follow us on Facebook, Twitter and YouTube
to keep up to date on our special offers and news.



Essence Frameless



Frameless Elegance

Ionic Essence is truly unique in its appearance with its fusion between stylish beauty and precision engineering. We have spent a great deal of time developing this range that not only exudes style; it also stays true to the basic Ionic principle: built to last.

Some additional features include concealed rollers to ensure it looks just as good on the inside as it does on the outside, discreet seals to help retain its frameless look, extra strong rollers that have gone through rigorous testing procedures along with many other little details that have been incorporated to ensure this product fits as seamlessly as possible for the installer.

Features

- Height 2000mm
- Stunning frameless design
- Reversible*
- Concealed fixings
- Exclusive Essence fixings kit provided
- Chrome double handle

Design Details



1 Branded glass clamp



4 Designer hinge with concealed pivot



2 Solid chrome double handle



3 Branded badge



5 Chrome double handle

*Quadrant Doors are handed.



11 Sliding Door in a Recess



13 Sliding Door with a Side Panel



15 Hinge & Inline Panel in a Recess

Frameless Elegance

The attention to detail is evident throughout this range with many additional clever features that ensure it is practical and functional while also maintaining its frameless elegance.



17 Hinge & Inline Panel with a Side Panel



19 1 Door Offset Quadrant



21 1 Door Quadrant



Features



2000mm



Concealed fixing



Reversible



Smooth action
extra strong rollers



Stunning frameless design



Discreet deflection seal
on luna rail for increased
water retention



Minimalist designer rail
with concealed rollers both
inside and outside



Chrome double handle

Essence Frameless

Sliding Door in a Recess



Product Details

Extension profiles available see page 79

Technical Details

A = Door Opening
B = Fixed Panel

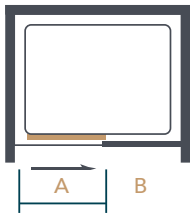









Size	Adjustment (Min-Max)	Order Code	Price £ Exc. VAT	Price £ Inc. VAT
1000	950-990	A0104A0	753.20	903.84
1100	1050-1090	A0104B0	753.20	903.84
1200	1150-1190	A0104IH	753.20	903.84
1400	1350-1390	A0104DH	798.90	958.68
1700	1650-1690	A0104HH	913.20	1095.84

Size	A	B
1000	365	465
1100	415	515
1200	465	565
1400	565	665
1700	565	965



Features



-  2000mm
-  Concealed fixing
-  Reversible
-  Smooth action extra strong rollers
-  Stunning frameless design
-  Discreet deflection seal on luna rail for increased water retention
-  Minimalist designer rail with concealed rollers both inside and outside
-  Chrome double handle

Essence Frameless

Sliding Door with a Side Panel



Product Details

Extension profiles available see page 79

Technical Details

A = Door Opening
B = Fixed Panel

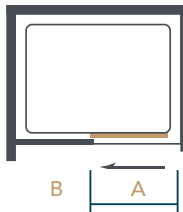

Please Note: The door needs to close against the side panel.

Size	Adjustment (Min-Max)	Order Code	Price £ Exc. VAT	Price £ Inc. VAT
1000	940-965	A0104A0	753.20	903.84
1100	1040-1065	A0104B0	753.20	903.84
1200	1140-1165	A0104IH	753.20	903.84
1400	1340-1365	A0104DH	798.90	958.68
1700	1640-1665	A0104HH	913.20	1095.84
Optional Side Panel				
800	760-785	A0107I0	410.30	492.36
900	860-885	A0107J0	433.20	519.84

Size	A	B
1000	350	465
1100	400	515
1200	450	565
1400	550	665
1700	550	965



Features



2000mm



Concealed fixing



Reversible



Solid chrome double handle symmetrical to hinges



Solid designer hinge with concealed pivot point



Stunning frameless design

Hinge & Inline Panel in a Recess



Product Details

Extension profiles available see page 79

Technical Details

- A = Door Opening
- B = Door Swing
- C = Inline Panel

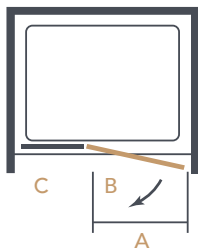

Please Note: Side Panel should only be used with + sizes (not standard sizes).

Size	A	B	C
760	440	460	160
800	440	460	200
800+	480	500	200
900	490	510	250
900+	530	550	250
1000	540	560	300
1000+	580	600	300
1100	590	610	350
1100+	630	650	350
1200	590	610	450
1200+	630	650	450
1400	590	610	650
1400+	630	650	650
1500	590	610	750
1500+	630	650	750

Size	Adjustment (Min-Max)	Order Code	Price £ Exc. VAT	Price £ Inc. VAT
760	720-760	A0111F0	649.20	779.04
800	760-800	A0111C0	649.20	779.04
800+	800-840	A0111M0	649.20	779.04
900	860-900	A0111D0	649.20	779.04
900+	900-940	A0111N0	649.20	779.04
1000	960-1000	A0111E0	683.50	820.20
1000+	1000-1040	A0111O0	683.50	820.20
1100	1060-1100	A0111JH	723.50	868.20
1100+	1100-1140	A0111JF	723.50	868.20
1200	1160-1200	A0111GH	723.50	868.20
1200+	1200-1240	A0111GF	723.50	868.20
1400	1360-1400	A0111HH	776.10	931.32
1400+	1400-1440	A0111HF	776.10	931.32
1500	1460-1500	A0111KH	833.20	999.84
1500+	1500-1540	A0111KF	833.20	999.84



Features



- 2000mm
- Concealed fixing
- Reversible
- Solid chrome double handle symmetrical to hinges
- Solid designer hinge with concealed pivot point
- Stunning frameless design

Essence Frameless

Hinge & Inline Panel with Side Panel



Product Details

Extension profiles available see page 79

Technical Details

A = Door Opening
B = Door Swing
C = Inline Panel

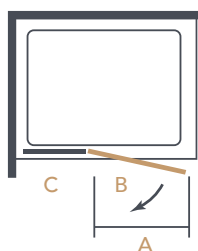

Please Note: Side Panel should only be used with + sizes (not standard sizes).

Size	A	B	C
800+	480	500	200
900+	530	550	250
1000+	580	600	300
1100+	630	650	350
1200+	630	650	450
1400+	630	650	650
1500+	630	650	750

Size	Adjustment (Min-Max)	Order Code	Price £ Exc. VAT	Price £ Inc. VAT
800+	770-790	A0111M0	649.20	779.04
900+	870-890	A0111N0	649.20	779.04
1000+	970-990	A0111O0	683.50	820.20
1100+	1070-1090	A0111JF	723.50	868.20
1200+	1170-1190	A0111GF	723.50	868.20
1400+	1370-1390	A0111HF	776.10	931.32
1500+	1470-1490	A0111KF	833.20	999.84

Optional Side Panel

800	750-790	A0107G0	376.00	451.20
900	850-890	A0107H0	398.90	478.68



Features

1 Door Offset Quadrant shown as Left Hand



2000mm



Concealed fixing



Smooth action
extra strong rollers



Chrome double handle



Stunning frameless design



Minimalist designer rail
with concealed rollers
both inside and out



Discreet deflector seal on luna rail
for increased water retention

Essence Frameless

1 Door Offset Quadrant



1 Door Offset Quadrant

Product Details

Extension profiles available see page 79

Technical Details

- A = Door Opening
- B = Straight Panel
- C = Curved Panel

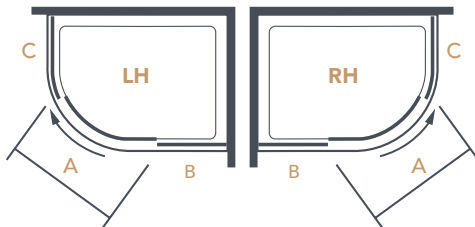

Size	Adjustment (Min-Max)	Handed	Order Code	Price £ Exc. VAT	Price £ Inc. VAT
1200x900	860-885 / 1160-1185	Left Hand	A0101KH	1141.80	1370.16
1200x900	860-885 / 1160-1185	Right Hand	A0101LH	1141.80	1370.16









Size	A	B	C
1200x900	475	590	550



Features

1 Door Quadrant shown as Left Hand



-  2000mm
-  Concealed fixing
-  Smooth action extra strong rollers
-  Chrome double handle
-  Stunning frameless design
-  Minimalist designer rail with concealed rollers both inside and out
-  Discreet deflector seal on luna rail for increased water retention
-  Extra strong rollers with additional guide to added smoothness

Essence Frameless

1 Door Quadrant



1 Door Quadrant

Product Details

Extension profiles available see page 79

Technical Details

- A = Door Opening
- B = Straight Panel
- C = Curved Panel

Size	Adjustment (Min-Max)	Handed	Order Code	Price £ Exc. VAT	Price £ Inc. VAT
900x900	860-885	Left Hand	A0101MH	1027.50	1233.00
900x900	860-885	Right Hand	A0101NH	1027.50	1233.00

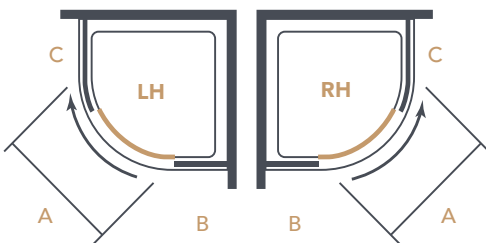

Size	A	B	C
900	475	290	550

Essence Framed



Precision Engineered

Ionic Essence Framed is a stylish 8mm range, precision engineered to suit every bathroom space. Some of the main features of this range include the solid "Clunk" which highlights the quality of these enclosures. Colour matched chrome magnetic seals and concealed fittings to ensure it looks great all around and quick release double rollers which makes it hassle-free to clean.

Features

-  Height 1900mm
-  Concealed fixings
-  Solid 'Clunk' close
-  Reversible
-  Colour matched chrome magnetic seals

Design Details





24 Sliding Door with a Side Panel



25 Sliding Door without a Side Panel



27 2 Door Quadrant

Precision Engineered

The framed beauty of this range delivers on functionality while maintaining the Ionic principle: built to last.



29 1 Door Quadrants



31 Pivot Door with Side Panel



33 Bifold Door



Features

Sliding Door with Side Panel



1900mm



Concealed fixing



Reversible



Easy clean quick release rollers



Chrome finish including top cover caps



Chrome magnetic strips



Smooth action extra strong rollers

Sliding Door with or without a Side Panel



Sliding Door in Recess

Product Details

Extension profiles available see page 79

Technical Details

A = Door Opening
B = Fixed Panel

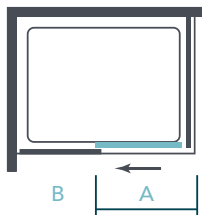

Size	A	B
1000	360	380
1100	410	430
1200	460	480
1400	560	580
1700	560	880

Size	Adjustment (Min-Max)	Order Code	Price £ Exc. VAT	Price £ Inc. VAT
1000	930-990	DWH04A0	519.10	622.92
1100	1030-1090	DWH04BI	519.10	622.92
1200	1130-1190	DWH04C0	519.10	622.92
1400	1330-1390	DWH04DH	599.80	719.76
1700	1630-1690	DWH04EH	692.50	831.00

Optional Side Panel				
Size	Adjustment (Min-Max)	Order Code	Price £ Exc. VAT	Price £ Inc. VAT
760	720-750	DWH07B0	241.80	290.16
800	760-790	DWH07D0	241.80	290.16
900	860-890	DWH07E0	285.10	342.12



Features



1900mm



Concealed fixing



Reversible



Easy clean quick release rollers



Chrome finish including top cover caps



Chrome magnetic strips

Essence Framed

2 Door Quadrant



Product Details

Extension profiles available see page 79

Technical Details

A = Door Opening
B = Fixed Panel

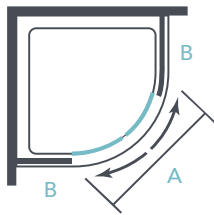

Size	Adjustment (Min-Max)	Order Code	Price £ Exc. VAT	Price £ Inc. VAT
800	750-780	DWH02A0	649.10	778.92
900	850-880	DWH02B0	649.10	778.92
1000	950-980	DWH02CH	735.80	882.96

Size	A	B
800	370	180
900	520	280
1000	520	380



Features

1 Door Offset Quadrant



1900mm



Easy clean quick release rollers



Reversible



Concealed fixing



Chrome finish including top cover caps

Essence Framed

1 Door Quadrants



1 Door Quadrant

Product Details

Extension profiles available see page 79

Technical Details

1 Door Quadrant

A = Door Opening
B = Straight Panel
C = Curved Panel

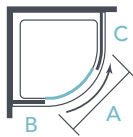

Size	A	B	C
900	450	330	460

1 Door Offset Quadrant

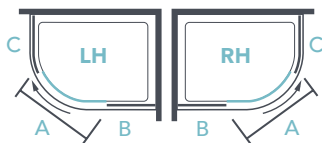

Size	A	B	C
1000x800	394	430	430
1200x800	394	630	430
1200x900	450	630	460

Size	Adjustment (Min-Max)	Order Code	Price £ Exc. VAT	Price £ Inc. VAT
------	----------------------	------------	------------------	------------------

1 Door Quadrant				
900	850-880	DWH03DH	718.50	862.20
1 Door Offset Quadrant				
1000x800	750-780 / 950-980	DWH03BH	744.50	893.40
1200x800	750-780 / 1150-1180	DWH03CH	744.50	893.40
1200x900	850-880 / 1150-1180	DWH03EH	744.50	893.40



Pivot Door shown with Side Panel

Features



1900mm



Concealed fixing



Reversible



Chrome finish including top cover caps



Coloured matching chrome magnetic seals



Solid "Clunk" close

Essence Framed

Pivot Door with or without Side Panel



Pivot Door in Recess

Product Details

Extension profiles available see page 79

Technical Details

A = Door Opening

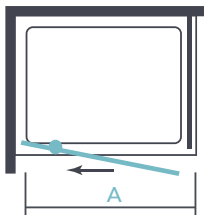

Size	Adjustment (Min-Max)	Order Code	Price £ Exc. VAT	Price £ Inc. VAT
------	----------------------	------------	------------------	------------------

760	690-750	DWH06B0	432.50	519.00
800	730-790	DWH06D0	458.50	550.20
900	830-890	DWH06E0	475.80	570.96

Optional Side Panel

760	720-750	DWH07B0	241.80	290.16
800	760-790	DWH07D0	241.80	290.16
900	860-890	DWH07E0	285.10	342.12

Size	A
760	433
800	473
900	573



Features

Bifold Door with Side Panel



1900mm



Concealed fixing



Space saving solution



Chrome finish including top cover caps



Reversible

Essence Framed

Bifold Door



Bifold Door in Recess

Product Details

Extension profiles available see page 79

Technical Details

A = Door Opening

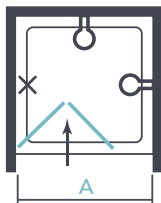

Size	A
760	436
800	476
900	576
1000	626

Size	Adjustment (Min-Max)	Order Code	Price £ Exc. VAT	Price £ Inc. VAT
760	690-750	DWH00B0	498.00	597.60
800	730-790	DWH00C0	498.00	597.60
900	830-890	DWH00D0	526.00	631.20
1000	930-990	DWH00E0	599.00	718.80
Optional Side Panel				
760	720-750	DWH07B0	241.80	290.16
800	760-790	DWH07D0	241.80	290.16
900	860-890	DWH07E0	285.10	342.12

Wetroom Panels



Flexibility for your Space

The Ionic range of Wetroom Panels offer you the choice to mix and match many combinations of shapes and sizes to any space you require. At Ionic Merlyn, we understand that every wetroom space is different, which is why we have designed a modular system of wetroom panels that can be combined to fit any area. We have broken the range down to 17 key components with additional fitting options which you can build together to make up the full wetroom of your choice. It's as simple as A, B, C.

Wetroom Panels

Diagram Ref	Size	Adjustment Min-Max	Order Code	Price £ Exc. VAT	Price £ Inc. VAT
A	NEW 300**	275-290	A0409J0	239.00	286.80
B	NEW 400**	375-390	A0409K0	249.00	298.80
C	NEW 500**	475-490	A0409L0	259.00	310.80
D	NEW 600**	575-590	A0409M0	269.00	322.80
E	700*	675-690	A0409A0	292.60	351.12
F	800*	775-790	A0409B0	292.60	351.12
G	900*	875-890	A0409C0	292.60	351.12
H	1000	975-990	A0409D0	317.70	381.24
I	1100	1075-1090	A0409F0	341.70	410.04
J	1200	1175-1190	A0409E0	341.70	410.04
K	1400	1375-1390	A0409G0	398.90	478.68
L	NEW 1600	1575-1590	A0409H0	449.00	538.80
M	NEW 200	Swivel Panel	A0413H0	163.00	195.60
N	300	Swivel Panel	A0413G0	170.30	204.36
O	NEW 400	Swivel Panel	A0413J0	184.00	220.80
P	300	Cube Panel	A0413F0	147.40	176.88
P	3000	Vertical Post	A0417C0	147.40	176.88

*Please Note: Panels A-G are the only panels that can be used as an end panel.

**Please Note: Panels A-D do not come with a stabilising bar / Panels E - L come with stabilising bar.

Fitting Options

	Size	Product	Order Code	Price £ Exc. VAT	Price £ Inc. VAT
NEW	1000	8mm round stabilising bar	A0417A0	94.61	113.53
NEW	-	Round T Piece bracket	A0450010	42.52	51.02
NEW	350	Angled stabilising bar	SP08SCU12320	92.48	110.98
NEW	2000	Corner profile	A0450003	43.68	52.42

Features

- Height 2015mm (including rail)
- Reversible
- Optional vertical post, swivel panel and cube panel available
- All panels above 700mm come with a 1000mm stabilising bar
- New corner profile option available
- Suitable for recess or corner situation
- Swivel panel can be retrofitted to any 8mm shower wall
- 3M support post can be retro-fitted to glass thicknesses of 6mm, 8mm and 10mm

How it Works

If you wanted to make up a Walk In Wetroom for an area to fit on to a 1200mm x 800mm tray or floor. You pick a panel E (700mm) and a B (800mm), this also includes the recommended 500mm minimum opening for the Walk In.

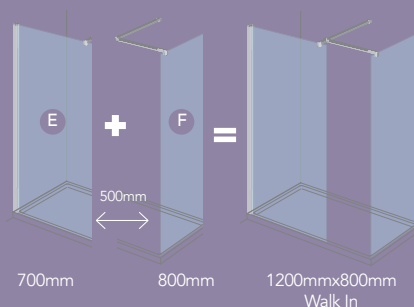

Minimum Opening

We recommend a minimum opening of 500mm for any wetroom area.

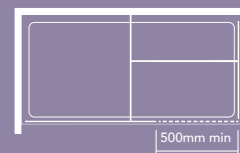



36 Showerwalls



37 Showerwall with Vertical Post



38 Walk In



39 Walk In with Swivel Panel

Flexibility for your Space

With innovative sizes and panels built with luxurious 8mm glass, this range is sure to impress.



40 Cube



41 Showerwall x 2 with Corner Profile

Showerwalls



Showerwall with Swivel Panel

Product Details

Diagram Code	Size	Adjustment (Min-Max)	Order Code	Price £ Exc. VAT	Price £ Inc. VAT
A	NEW 300**	275-290	A0409J0	239.00	286.80
B	NEW 400**	375-390	A0409K0	249.00	298.80
C	NEW 500**	475-490	A0409L0	259.00	310.80
D	NEW 600**	575-590	A0409M0	269.00	322.80
E	700*	675-690	A0409A0	292.60	351.12
F	800*	775-790	A0409B0	292.60	351.12
G	900*	875-890	A0409C0	292.60	351.12
H	1000	975-990	A0409D0	317.70	381.24
I	1100	1075-1090	A0409F0	341.70	410.04
J	1200	1175-1190	A0409E0	341.70	410.04
K	1400	1375-1390	A0409G0	398.90	478.68
L	NEW 1600	1575-1590	A0409H0	449.00	538.80
M	NEW 200	Swivel Panel	A0413H0	163.00	195.60
N	300	Swivel Panel	A0413G0	170.30	204.36
O	NEW 400	Swivel Panel	A0413J0	184.00	220.80
P	300	Cube Panel	A0413F0	147.40	176.88
Q	3000	Vertical Post	A0417C0	147.40	176.88

Features



- 2015mm (including rail)
- Reversible
- 180 degree swivel on Swivel Panel
- Can be used on tray or wetroom floor
- Suitable for recess or corner situation
- Swivel panel can be retrofitted to any 8mm Shower Wall

*Please Note: Panels A-G are the only panels that can be used as an end panel.

**Please Note: Panels A-D do not come with a stabilising bar / Panels E-L come with stabilising bar.

Showerwalls with Vertical Post



Features



-  2015mm (including rail)
-  Reversible
-  Can be used on tray or wetroom floor
-  Suitable for recess or corner situation
-  Swivel panel can be retrofitted to any 8mm Shower Wall
-  3M support post can be retro-fitted to glass thicknesses of 6mm, 8mm and 10mm

Product Details

Diagram Code	Size	Adjustment (Min-Max)	Order Code	Price £ Exc. VAT	Price £ Inc. VAT
A	NEW 300**	275-290	A0409J0	239.00	286.80
B	NEW 400**	375-390	A0409K0	249.00	298.80
C	NEW 500**	475-490	A0409L0	259.00	310.80
D	NEW 600**	575-590	A0409M0	269.00	322.80
E	700*	675-690	A0409A0	292.60	351.12
F	800*	775-790	A0409B0	292.60	351.12
G	900*	875-890	A0409C0	292.60	351.12
H	1000	975-990	A0409D0	317.70	381.24
I	1100	1075-1090	A0409F0	341.70	410.04
J	1200	1175-1190	A0409E0	341.70	410.04
K	1400	1375-1390	A0409G0	398.90	478.68
L	NEW 1600	1575-1590	A0409H0	449.00	538.80
Q	3000	Vertical Post	A0417C0	147.40	176.88

*Please Note: Panels A-G are the only panels that can be used as an end panel.

**Please Note: Panels A-D do not come with a stabilising bar / Panels E-L come with stabilising bar.

Walk In



Product Details

Diagram Code	Size	Adjustment (Min-Max)	Order Code	Price £ Exc. VAT	Price £ Inc. VAT
A	NEW 300**	275-290	A0409J0	239.00	286.80
B	NEW 400**	375-390	A0409K0	249.00	298.80
C	NEW 500**	475-490	A0409L0	259.00	310.80
D	NEW 600**	575-590	A0409M0	269.00	322.80
E	700*	675-690	A0409A0	292.60	351.12
F	800*	775-790	A0409B0	292.60	351.12
G	900*	875-890	A0409C0	292.60	351.12
H	1000	975-990	A0409D0	317.70	381.24
I	1100	1075-1090	A0409F0	341.70	410.04
J	1200	1175-1190	A0409E0	341.70	410.04
K	1400	1375-1390	A0409G0	398.90	478.68
L	NEW 1600	1575-1590	A0409H0	449.00	538.80

Features



2015mm (including rail)



Reversible



Can be used on tray or wetroom floor



Suitable for Recess or Corner Situation



Can be used on tray or wetroom floor

Technical Details

We recommend a minimum opening of 500mm for any wetroom panel combination.

*Please Note: Panels A-G are the only panels that can be used as an end panel.

**Please Note: Panels A-D do not come with a stabilising bar / Panels E-L come with stabilising bar.

Walk In with Swivel Panel



Features



- 2015mm (including rail)
- Reversible
- 180 degree swivel on Swivel Panel
- Can be used on tray or wetroom floor
- Suitable for Recess or Corner Situation
- Swivel panel can be retrofitted to any 8mm Shower Wall

Technical Details

We recommend a minimum opening of 500mm for any wetroom panel combination.

Product Details

Diagram Code	Size	Adjustment (Min-Max)	Order Code	Price £ Exc. VAT	Price £ Inc. VAT
A	NEW 300**	275-290	A0409J0	239.00	286.80
B	NEW 400**	375-390	A0409K0	249.00	298.80
C	NEW 500**	475-490	A0409L0	259.00	310.80
D	NEW 600**	575-590	A0409M0	269.00	322.80
E	700*	675-690	A0409A0	292.60	351.12
F	800*	775-790	A0409B0	292.60	351.12
G	900*	875-890	A0409C0	292.60	351.12
H	1000	975-990	A0409D0	317.70	381.24
I	1100	1075-1090	A0409F0	341.70	410.04
J	1200	1175-1190	A0409E0	341.70	410.04
K	1400	1375-1390	A0409G0	398.90	478.68
L	NEW 1600	1575-1590	A0409H0	449.00	538.80
M	NEW 200	Swivel Panel	A0413H0	163.00	195.60
N	300	Swivel Panel	A0413G0	170.30	204.36
O	NEW 400	Swivel Panel	A0413J0	184.00	220.80

*Please Note: Panels A-G are the only panels that can be used as an end panel.

**Please Note: Panels A-D do not come with a stabilising bar / Panels E-L come with stabilising bar.

Cube



Product Details

Diagram Code	Size	Adjustment (Min-Max)	Order Code	Price £ Exc. VAT	Price £ Inc. VAT
A	NEW 300**	275-290	A0409J0	239.00	286.80
B	NEW 400**	375-390	A0409K0	249.00	298.80
C	NEW 500**	475-490	A0409L0	259.00	310.80
D	NEW 600**	575-590	A0409M0	269.00	322.80
E	700*	675-690	A0409A0	292.60	351.12
F	800*	775-790	A0409B0	292.60	351.12
G	900*	875-890	A0409C0	292.60	351.12
H	1000	975 -990	A0409D0	317.70	381.24
I	1100	1075-1090	A0409F0	341.70	410.04
J	1200	1175-1190	A0409E0	341.70	410.04
K	1400	1375-1390	A0409G0	398.90	478.68
L	NEW 1600	1575-1590	A0409H0	449.00	538.80
P	300	Cube Panel	A0413F0	147.40	176.88

Features



- 2015mm (including rail)
- Reversible
- Can be used on tray or wetroom floor
- Suitable for recess or corner situation
- Can be used on tray or wetroom floor

Technical Details

We recommend a minimum opening of 500mm for any wetroom panel combination
 Cube Panel width: 300mm.

*Please Note: Panels A-G are the only panels that can be used as an end panel.

**Please Note: Panels A-D do not come with a stabilising bar / Panels E-L come with stabilising bar.

Showerwall with Corner Panel



Features



2015mm (including rail)



Reversible



Can be used on tray or wetroom floor



Suitable for corner situation only



We recommend using a stabilising bar for all size panels with this configuration

Product Details

Diagram Code	Size	Adjustment (Min-Max)	Order Code	Price £ Exc. VAT	Price £ Inc. VAT
A	NEW 300**	275-290	A0409J0	239.00	286.80
B	NEW 400**	375-390	A0409K0	249.00	298.80
C	NEW 500**	475-490	A0409L0	259.00	310.80
D	NEW 600**	575-590	A0409M0	269.00	322.80
E	700*	675-690	A0409A0	292.60	351.12
F	800*	775-790	A0409B0	292.60	351.12
G	900*	875-890	A0409C0	292.60	351.12
H	1000	975-990	A0409D0	317.70	381.24
I	1100	1075-1090	A0409F0	341.70	410.04
J	1200	1175-1190	A0409E0	341.70	410.04
K	1400	1375-1390	A0409G0	398.90	478.68
L	NEW 1600	1575-1590	A0409H0	449.00	538.80
	NEW 2000	Corner Profile	A04S0003	43.68	52.42

Please Note: Corner Profile must be used with two Showerwall Panels

*Please Note: Panels A-G are the only panels that can be used as an end panel.

**Please Note: Panels A-D do not come with a stabilising bar / Panels E-L come with stabilising bar.

Express



The Ultimate Easy-fit Solution

The ultimate easy-fit shower enclosure system. Express by name, express by nature. With innovation at its core, the Ionic Express range has been designed with you in mind, this range has a unique east-fit system which makes it the easiest fit on the market.

Many of the pieces in this range come pre-assembled to save you time and effort. Not only is this range easy-fit, it has been developed to the highest quality standards while maintaining a stylish contemporary look and feel.



Watch our online fastfit demo

Features

- ✓ Unique easy fit system
- ✓ Height 1900mm
- ⇌ Reversible
- ✓ Quick release easy clean double rollers
- ✓ Fixed panels come pre-assembled to wall profile
- ✓ All rollers come pre-assembled on moving panels
- ✓ Additional inline panels available to fit awkward spaces

03 Easy Fit Steps



Step 01
Slot and connect
frame in place.



Step 02
Slide mechanism
to secure profile at
each corner.

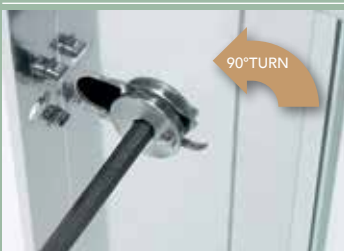

Step 03
Quarter turn to lock wall and
upright profiles in place,
without the need for drilling
through aluminium.



45 Sliding Door



47 Pivot Door



49 Bifold Door

**Express by Name
Express by Nature**

With innovation at its core, the Ionic Express range has been designed with a unique easy-fit system which makes it the easiest fit on the market.



51 2 Door Quadrants



53 1 Door Quadrant



Features

Sliding Door with Side Panel



1900mm



Easy-fit system



Reversible



Smooth action
extra strong rollers



Concealed fixing



Easy clean quick
release rollers



Double fin seal for
increased water retention



Rollers pre-assembled on door

03

Easy Fit Steps

The Easy Fit Range means less drilling and less screws. For installation instructions see page 42.

Express

Sliding Door



Sliding Door in Recess

Product Details

Extension profiles available see page 79

Technical Details

A = Door Opening
B = Fixed Panel

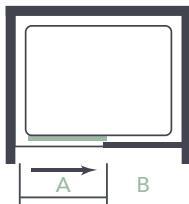

Size	A	B
1000	380	433
1100	430	483
1200	480	533
1400	580	633
1500	580	733
1600	580	833
1700	580	933

Size	Adjustment (Min-Max)	Order Code	Price £ Exc. VAT	Price £ Inc. VAT
1000	950-990	A0304A0	398.90	478.68
1100	1050-1090	A0304B0	398.90	478.68
1200	1150-1190	A0304C0	398.90	478.68
1400	1350-1390	A0304DH	513.20	615.84
1500	1450-1490	A0304GH	546.30	655.56
1600	1550-1590	A0304EH	558.90	670.68
1700	1650-1690	A0304HH	565.80	678.96

Optional Side Panel (Please add 5mm to adjustment when used with side panel)				
700	650-670	A0307A0	245.70	294.84
760	710-730	A0307B0	245.70	294.84
800	750-770	A0307D0	245.70	294.84
900	850-870	A0307E0	270.90	325.08

Ionic Express Inline Panel (For more details see page 80)				
150	130-150	A0315B0	204.60	245.52
210	190-210	A0315C0	204.60	245.52
490 (New)	470-490	A0315D0	239.20	287.04

For Inline Panel size calculations please see page 80.

Please Note: Sliding Door can be paired with 2 additional Side Panels.



Pivot Door with Inline Panel & Side Panel

Pivot Door with Side Panel

Features



1900mm



Concealed fixing



Easy-fit system



20mm adjustment per wall profile



Reversible

01

Easy Fit Step

The Easy Fit Range means less drilling and less screws. For installation instructions see page 42.

Express

Pivot Door



Pivot Door in Recess

Product Details

Extension profiles available see page 79

Technical Details

A = Door Opening

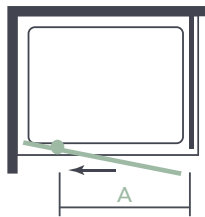

Size	A	B
700	415	390
760	475	450
800	515	490
900	615	590
1000	715	690

Size	Adjustment (Min-Max)	Order Code	Price £ Exc. VAT	Price £ Inc. VAT
700	650-690	A0306A0	340.60	408.72
760	710-750	A0306B0	340.60	408.72
800	750-790	A0306D0	340.60	408.72
900	850-890	A0306E0	392.00	470.40
1000	950-990	A0306G0	432.00	518.40

Optional Side Panel (Please add 5mm to door adjustment when used with side panel)				
700	650-670	A0307A0	245.70	294.84
760	710-730	A0307B0	245.70	294.84
800	750-770	A0307D0	245.70	294.84
900	850-870	A0307E0	270.90	325.08

Ionic Express Inline Panel (For more details see page 80)				
150	130-150	A0315B0	204.60	245.52
210	190-210	A0315C0	204.60	245.52
490 (new)	470-490	A0315D0	239.20	287.04

For Inline Panel size calculations please see page 80.



Bifold Door with Inline Panel in a Recess

Bifold Door with Side Panel

Features



1900mm



Easy-fit system



Reversible



Concealed fixing



Discreet chrome bifold hinge



20mm adjustment per wall profile

01

Easy Fit Step

The Easy Fit Range means less drilling and less screws. For installation instructions see page 42.

Express

Bifold Door



Bifold Door in Recess

Product Details

Extension profiles available see page 79

Technical Details

A = Door Opening

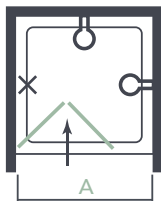

Size	A
760	475
800	515
900	615
1000	715

Size	Adjustment (Min-Max)	Order Code	Price £ Exc. VAT	Price £ Inc. VAT
760	710-750	A0300B0	381.80	458.16
800	750-790	A0300C0	381.80	458.16
900	850-890	A0300D0	408.00	489.60
1000	950-990	A0300E0	474.30	569.16

Optional Side Panel (Please add 5mm to adjustment when used with side panel)				
700	650-670	A0307A0	245.70	294.84
760	710-730	A0307B0	245.70	294.84
800	750-770	A0307D0	245.70	294.84
900	850-870	A0307E0	270.90	325.08

Ionic Express Inline Panel (For more details see page 80)				
150	130-150	A0315B0	204.60	245.52
210	190-210	A0315C0	204.60	245.52
490 (New)	470-490	A0315D0	239.20	287.04

For Inline Panel size calculations please see page 80.



Features

2 Door Offset Quadrant



1900mm



Easy-fit system



Reversible



Concealed fixing



Double fin seal for increased water retention



Easy clean quick release rollers



Smooth action extra strong rollers



Rollers pre-assembled on door

03

Easy Fit Steps

The Easy Fit Range means less drilling and less screws. For installation instructions see page 42.

Express

2 Door Quadrant



2 Door Quadrant

Product Details

Extension profiles available see page 79

Technical Details

A = Door Opening
B = Fixed Panel
C = Fixed Panel

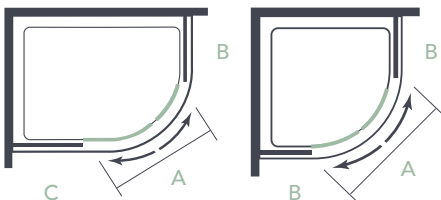

Size	A	B	C
------	---	---	---

2 Door Offset Quadrant

900x760	430	321	181
1000x800	465	421	221
1200x800	465	621	221
1200x900	540	621	321

2 Door Quadrant

800	390	221
900	540	321

Size	Adjustment (Min-Max)	Order Code	Price £ Exc. VAT	Price £ Inc. VAT
------	----------------------	------------	------------------	------------------

2 Door Offset Quadrant

900x760	855-875 / 715-735	A0302C0	513.20	615.84
1000x800	955-975 / 755-775	A0302D0	558.90	670.68
1200x800	1155-1175 / 755-775	A0302HH	648.10	777.72
1200x900	1155-1175 / 855-875	A0302IH	668.60	802.32

2 Door Quadrant

800	755-775	A0302A0	456.00	547.20
900	855-875	A0302B0	456.00	547.20

20mm Adjustment per wall profile.











Easy clean quick release rollers

1 Door Quadrant

Features





-  1900mm
-  Concealed fixing
-  Smooth action extra strong rollers
-  Easy-fit system
-  Double fin seal for increased water retention
-  Rollers pre-assembled on door
-  Reversible
-  Easy clean quick release rollers

03

Easy Fit Steps

The Easy Fit Range means less drilling and less screws. For installation instructions see page 42.

Express

1 Door Quadrant



Product Details

Extension profiles available see page 79

Technical Details

A = Door Opening
 B = Fixed Panel
 C = Fixed Panel

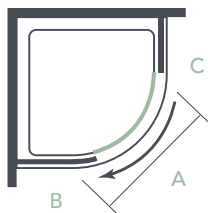

Size	Adjustment (Min-Max)	Order Code	Price £ Exc. VAT	Price £ Inc. VAT
------	----------------------	------------	------------------	------------------

900	855-875	A0301B0	558.90	670.68
-----	---------	---------	--------	--------

Size	A	B	C
900	460	526	321

Source

Affordable Shower Enclosures

Ionic Source is our exciting range of affordable 6mm shower enclosures created by Merlyn. This range has been developed to offer our customers an exceptional quality shower enclosure without the hefty price tag.

Ionic Source has a fresh, contemporary look and feel. With simple clean lines, these showers will remain timeless for years to come. Standing at 1850mm high with 6mm* toughened glass with easy fit frame, robust quick release easy clean rollers, secure clunk closing and discreet modern fittings, the attention to detail and emphasis on quality is clearly evident throughout this range.

03 Easy Fit Steps



Step 01
Align the horizontal and vertical profiles together.



Step 02
Slot the horizontal profile and screws into upright using guide channel until flush.

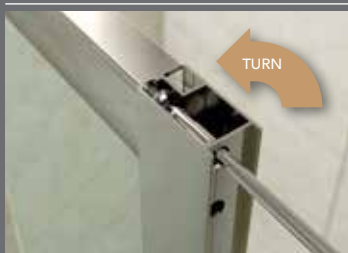

Step 03
Secure screws into position using dedicated access holes.

*Bifold door has 4mm glass



56 Sliding Door



57 2 Door Quadrants



58 Pivot Door

Quality Without the Hefty Price-tag

With our new 3 step pre-assembled frames the Ionic Source range is now easier and quicker to install than ever before.



59 Bifold Door



60 Corner Door

Source

Sliding Door



Chrome Handle



Sliding Door in a Recess

Product Details

Extension profiles available see page 79

Size	Adjustment (Min-Max)	Order Code	Price £ Exc. VAT	Price £ Inc. VAT
1000	950-990	A1204A0	237.20	284.64
1100	1050-1090	A1204B0	237.20	284.64
1200	1150-1190	A1204C0	246.70	296.04

20mm Adjustment per wall profile.

Optional Side Panels				
Size	Adjustment (Min-Max)	Order Code	Price £ Exc. VAT	Price £ Inc. VAT
760	730-750	A1207B0	141.90	170.28
800	770-790	A1207D0	141.90	170.28
900	870-890	A1207E0	151.40	181.68

Technical Details

Size	A	B
1000	380	400
1100	430	450
1200	480	500

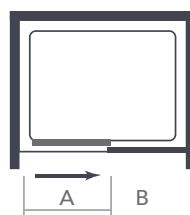

A = Door Opening
B = Fixed Panel

Features



1850mm



Chrome quick release easy clean bottom rollers



Reversible



Easy fit frame



Screw cover caps



Magnetic seals

Source

2 Door Quadrants



Features



1850mm



Chrome quick release
easy clean bottom rollers



Reversible



Easy fit frame



Fixing cover caps



Magnetic seals

Product Details

Extension profiles available see page 79

Size	Adjustment (Min-Max)	Order Code	Price £ Exc. VAT	Price £ Inc. VAT
800	770-790	A1202A0	237.20	284.64
900	870-890	A1202B0	237.20	284.64
1000x800	970-990 / 770-790	A1202D0	322.90	387.48
1200x800	1170-1190 / 770-790	A1202HH	332.40	398.88
1200x900	1170-1190 / 870-890	A1202IH	341.90	410.28

20mm Adjustment per wall profile.

Technical Details

Size	A	B	C
800	400	210	210
900	540	310	310
1000x800	470	410	210
1200x800	470	610	210
1200x900	540	610	310

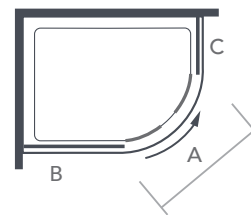

A = Door Opening
B = Fixed Panel
C = Fixed Panel

Source

Pivot Door



Product Details

Extension profiles available see page 79

Size	Adjustment (Min-Max)	Order Code	Price £ Exc. VAT	Price £ Inc. VAT
760	710-750	A1206B0	189.50	227.40
800	750-790	A1206D0	208.60	250.32
900	850-890	A1206E0	227.60	273.12

20mm adjustment per wall profile.

Optional Side Panels

760	730-750	A1207B0	141.90	170.28
800	770-790	A1207D0	141.90	170.28
900	870-890	A1207E0	151.40	181.68

Technical Details

Size	A	B
760	490	460
800	530	500
900	630	600

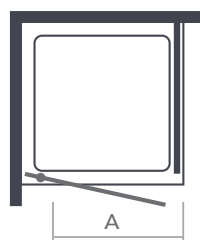

A = Door Opening

Features



1850mm



Reversible



Minimalist pivot



Pre-assembled frame



Screw cover caps



Magnetic seals

Source

Bifold Door



Features



1850mm



Reversible



Pre-assembled frame



Smooth running action



Screw cover caps



Magnetic seals

Product Details

Extension profiles available see page 79

Size	Adjustment (Min-Max)	Order Code	Price £ Exc. VAT	Price £ Inc. VAT
700	650-690	A1200A0	227.60	273.12
760	710-750	A1200B0	227.60	273.12
800	750-790	A1200C0	237.20	284.64
900	850-890	A1200D0	246.70	296.04

20mm Adjustment per wall profile.

Optional Side Panels

760	730-750	A1207B0	141.90	170.28
800	770-790	A1207D0	141.90	170.28
900	870-890	A1207E0	151.40	181.68

Technical Details

Size	A
700	400
760	460
800	500
900	600

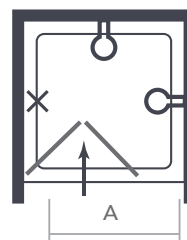

A = Door Opening

Source

Corner Door



Adjustable corner bracket

Product Details

Extension profiles available see page 79

Size	Adjustment (Min-Max)	Order Code	Price £ Exc. VAT	Price £ Inc. VAT
760/800	740-790	A1212V0	322.90	387.48
900	870 -890	A1212B0	332.40	398.88

20mm adjustment per wall profile.

Technical Details

Size	A
760/800	350-390
900	460

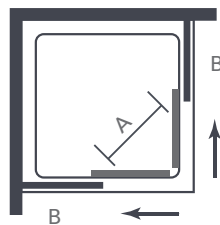

A = Door opening
B = Fixed panel

Features

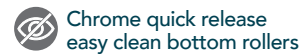

How SecureSeal works

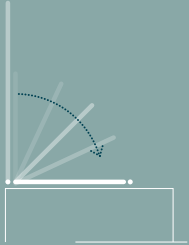

01.
Pull down arm
from storage
position.

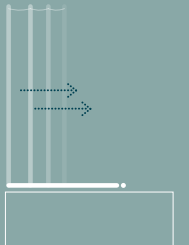

02.
Extend screen and
locate panels.

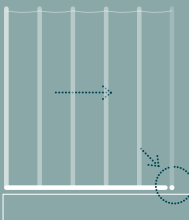

03.
Fully extend and
clip into position
for a secure fit
and tight seal.

.SecureSeal.

by MERLYN

The Ultimate Leak-free Bath Screen

The SecureSeal by Merlyn has been designed with a leak-free sealing arm which extends from the profile to create a complete seal between the bath and screen. When not in use the arm simply folds away back into the profile.

SecureSeal by Merlyn offers functional and easy to use designs to complement any bathroom space. With glass screen heights of 1500mm and 6mm glass, our SecureSeal by Merlyn range allows you to enjoy peace of mind in a leak-free shower experience for years to come.

This range has been designed with the same superb materials and unrelenting attention to detail demonstrated across all Merlyn ranges.



62 4 Fold



62 4 Fold with Fixed Panel



63 5 Fold



63 5 Fold with Fixed Panel



64 Single Panel



64 Single Panel with Fixed Panel

SecureSeal.

4 Fold



Product Details

Size	Adjustment (Min-Max)	Panels	Order Code	Price £ Exc. VAT	Price £ Inc. VAT
800x1500	780-800mm	4	MS4	349.10	418.92

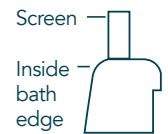
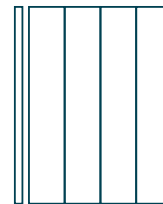

A = Moving panels (screen width when folded into the bath 228mm).

Recommended shower head position

4 Fold with Fixed Panel



Product Details

Size	Adjustment (Min-Max)	Panels	Order Code	Price £ Exc. VAT	Price £ Inc. VAT
800x1500	780-800mm	4	MS4	349.10	418.92
Optional SecureSeal Fixed Panel					
300x1500	300-320mm	1	MSFP	165.40	198.48

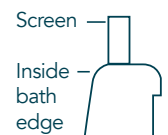
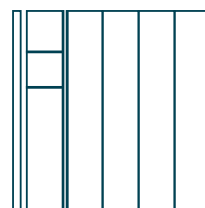

A = Moving panels (screen width when folded into the bath 228mm).

B = Fixed panel.

Recommended shower head position

SecureSeal.

5 Fold

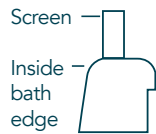
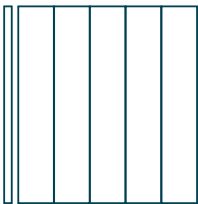

A = Moving panels (screen width when folded into the bath 228mm).

Recommended shower head position



Product Details

Size	Adjustment (Min-Max)	Panels	Order Code	Price £ Exc. VAT	Price £ Inc. VAT
1000x1500	980-1000mm	5	MS5	392.90	471.48

5 Fold with Fixed Panel

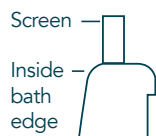

A = Moving panels (screen width when folded into the bath 228mm).

B = Fixed panel.

Recommended shower head position



Product Details

Size	Adjustment (Min-Max)	Panels	Order Code	Price £ Exc. VAT	Price £ Inc. VAT
1000x1500	980-1000mm	5	MS5	392.90	471.48

Optional SecureSeal Fixed Panel

300x1500	300-320mm	1	MSFP	165.40	198.48
----------	-----------	---	------	--------	--------

Single Panel

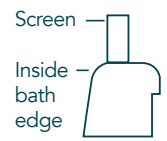
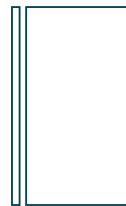
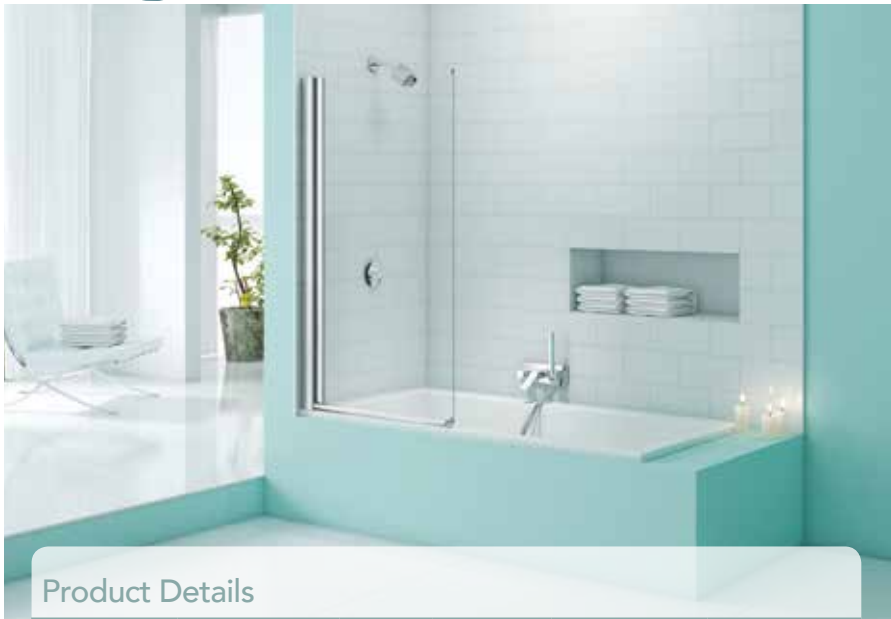

Product Details

Size	Adjustment (Min-Max)	Panels	Order Code	Price £ Exc. VAT	Price £ Inc. VAT
800x1500	780-800mm	1	MS1	209.10	250.92

A = Moving panels (screen width when folded into the bath 712mm).

Recommended shower head position

Single Panel with Fixed Panel

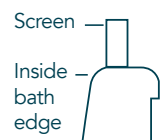
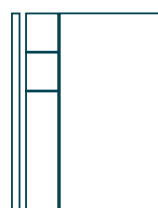
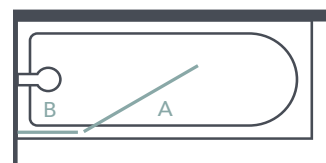
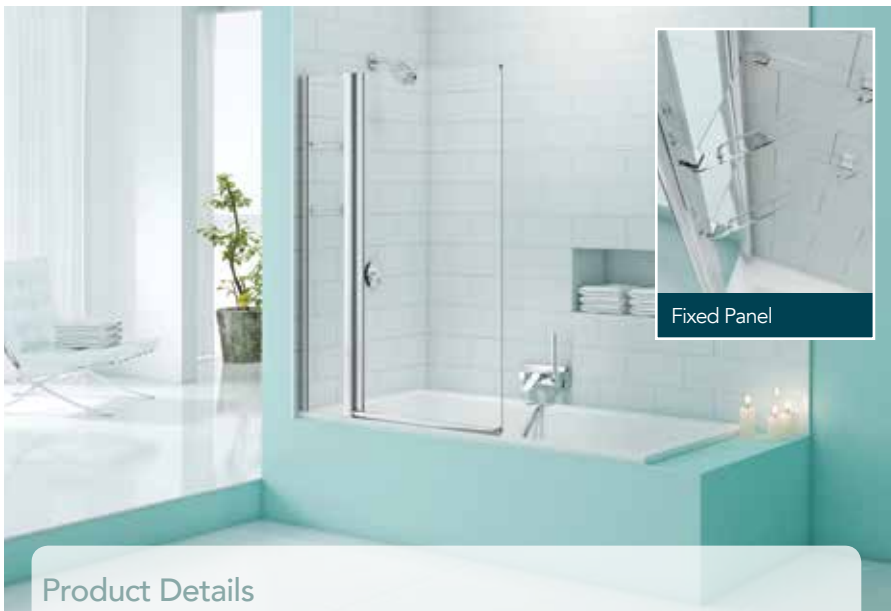

Product Details

Size	Adjustment (Min-Max)	Panels	Order Code	Price £ Exc. VAT	Price £ Inc. VAT
800x1500	780-800mm	1	MS1	209.10	250.92
Optional SecureSeal Fixed Panel					
300x1500	300-320mm	1	MSFP	165.40	198.48

A = Moving panels (screen width when folded into the bath 712mm).

B = Fixed panel.

Recommended shower head position

Bathscreens

Simple Shapes

Ionic Bath Screens are the perfect solution for in-bath showering. Innovative design and contemporary aesthetics bring this bathroom favourite to life with modern shapes and features to enjoy for years to come.

HydraSEAL

We have created an exciting new feature called HydraSEAL, and added to 3 of our featured bath screens. HydraSEAL acts as an extra barrier to reduce water escaping from your bathscreen during your showering experience. HydraSEAL is available on our MB1, MB2, MB3, MB3A and MB3B bath screens.

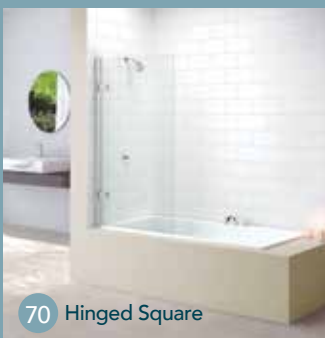



Fixed Square



Product Details

Size	Panels	Order Code	Price £ Exc. VAT	Price £ Inc. VAT
800x1500	1	MBO	108.60	130.32

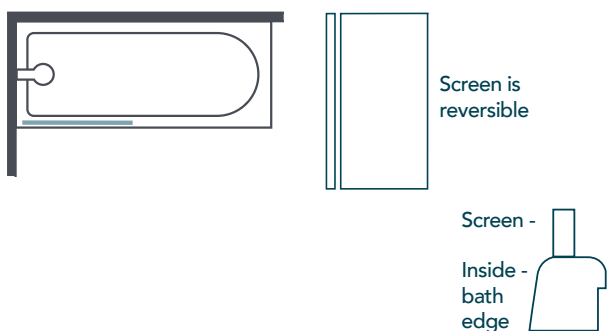

Single Curved



HydraSEAL



Product Details

Size	Panels	Order Code	Price £ Exc. VAT	Price £ Inc. VAT
800x1500	1	MB1	148.20	177.84

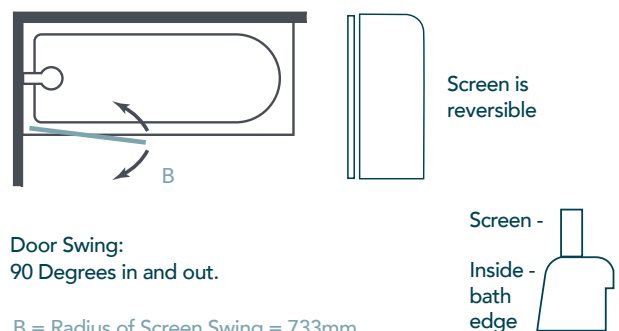



Single Square



Two Panel Curved



Product Details

Size	Panels	Order Code	Price £ Exc. VAT	Price £ Inc. VAT
800x1500	1	MB2	175.30	210.36

Product Details

Size	Panels	Order Code	Price £ Exc. VAT	Price £ Inc. VAT
1150x1500	2	MB3	414.30	497.16

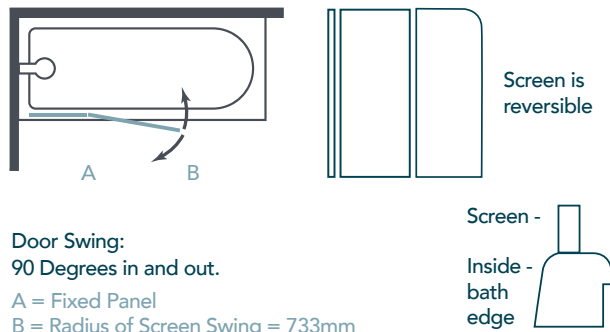
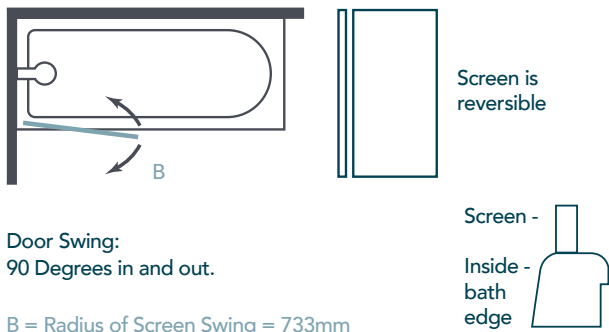

Recommended shower head position

Recommended shower head position



Two Panel Folding Curved



Two Panel Folding Square



Product Details

Size	Panels	Order Code	Price £ Exc. VAT	Price £ Inc. VAT
900x1500	2	MB3A	244.90	293.88

Product Details

Size	Panels	Order Code	Price £ Exc. VAT	Price £ Inc. VAT
900x1500	2	MB3B	244.90	293.88

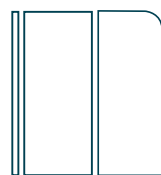
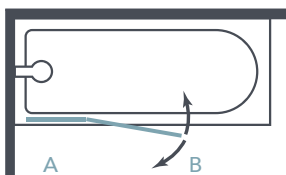

Screen is reversible

Door Swing:
90 Degrees in and out.
A = Fixed Panel
B = Radius of Screen Swing = 483mm



Recommended shower head position

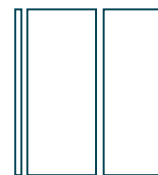
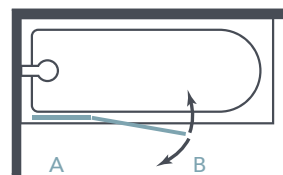

Screen is reversible

Door Swing:
90 Degrees in and out.
A = Fixed Panel
B = Radius of Screen Swing = 483mm



Recommended shower head position



Four Fold



Curtain Rail



Product Details

Size	Panels	Order Code	Price £ Exc. VAT	Price £ Inc. VAT
850x1400	4	MB4	290.90	349.08

Product Details

Size	Panels	Order Code	Price £ Exc. VAT	Price £ Inc. VAT
300x1500	1	MB5	194.90	233.88

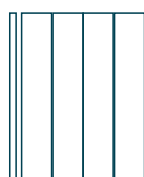

Screen is reversible



A = Moving Panels (panel width 200mm)

☉ Recommended shower head position

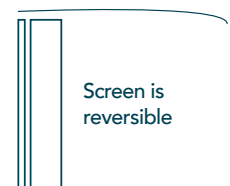
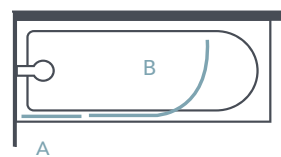

Screen is reversible



Height is 1550mm including rail.

A = Fixed Panel
B = Curtain Rail

☉ Recommended shower head position



Hinged Square



Product Details

Size	Panels	Order Code	Price £ Exc. VAT	Price £ Inc. VAT
850x1500	1	MB6	389.70	467.64

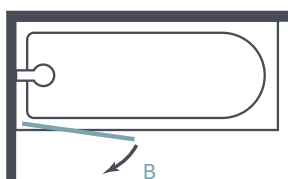

Screen is reversible

Door Swing:
90 Degrees outward swing only.

B = Radius of Screen Swing = 810mm

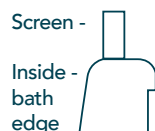

Screen -
Inside -
bath
edge

Recommended shower head position



Two Panel Hinged



Product Details

Size	Panels	Order Code	Price £ Exc. VAT	Price £ Inc. VAT
900x1500	2	MB7L (L)	475.00	570.00
900x1500	2	MB7R (R)	475.00	570.00

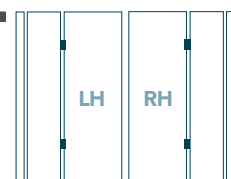
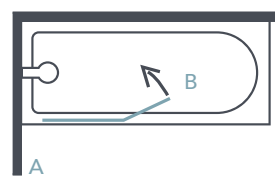

Screen is reversible

Door Swing:
180 Degrees inward only.

A = Fixed Panel
B = Radius of Screen Swing = 383mm



Screen -
Inside -
bath
edge

Recommended shower head position



Two Panel Folding



Three Panel Folding



Product Details

Size	Panels	Order Code	Price £ Exc. VAT	Price £ Inc. VAT
1100x1500	2	MB8	472.40	566.88



Product Details

Size	Panels	Order Code	Price £ Exc. VAT	Price £ Inc. VAT
1400x1500	3	MB9	590.80	708.96

Folding Panels

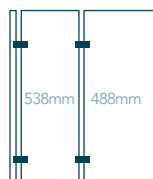
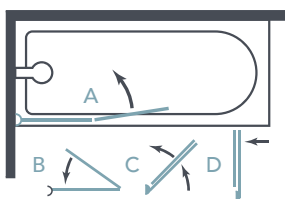

Screen is reversible

Door Swing:
180 Degrees Radius of screen swing inwards and outwards.



Recommended shower head position

Folding Panels

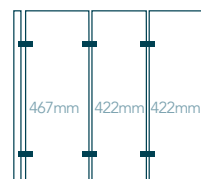
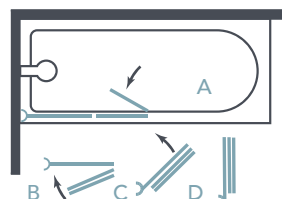

Screen is reversible

Door Swing:
180 Degrees Radius of Screen Swing inwards and outwards.



Recommended shower head position

Touchstone Tray



Features

- ✓ Single skinned with moulded solid under section
- ✓ 50mm high to achieve minimalist design
- ✓ 135mm high including tray panel kit
- ✓ Compatible 90mm fast flow waste also available
- ✓ More than 30 sizes available
- ✓ Available as low level or with tray panel kits for easy installation

Strong and Durable

Beautifully sculpted shower trays, angled and contoured to match enclosures and spaces, achieving the perfect combination of luxury, elegance and durability.

Design Details



Graduated adjustable leg and easy fit tray panel kit (Optional Extra).



90mm fast flow waste, includes hair trap and chrome cover (Optional Extra).



Graduated adjustable leg system.

Rectangular Tray



*Waste is centred on 1700x800 & 1700x900 trays.

Square Tray



TOUCHSTONE

Rectangle Tray

Tray Size	Order Code	Tray Panel Kit	Price £ Exc. VAT	Price £ Inc. VAT
800x700	S870RTTO	Kit 4	118.01	141.61
800x760	S876RTTO	Kit 4	118.01	141.61
900x700	S970RTTO	Kit 4	128.94	154.73
900x760	S976RTTO	Kit 4	128.94	154.73
900x800	S980RTTO	Kit 4	128.94	154.73
1000x700	S107RTTO	Kit 4	133.15	159.78
1000x760	S1076RTTO	Kit 4	133.15	159.78
1000x800	S108RTTO	Kit 4	133.15	159.78
1000x900	S109RTTO	Kit 4	138.27	165.92
1100x800	S118RTTO	Kit 4	138.27	165.92
1200x700	S127RTTO	Kit 4	138.27	165.92
1200x760	S1276RTTO	Kit 4	144.86	173.83
1200x800	S128RTTO	Kit 4	153.55	184.26
1200x900	S129RTTO	Kit 4	164.80	197.76
1300x800 (New)	S138RTTO	Kit 3	213.89	256.67
1400x700	S147RTTO	Kit 3	220.30	264.36
1400x760	S1476RTTO	Kit 3	220.30	264.36
1400x800	S148RTTO	Kit 3	220.30	264.36
1400x900	S149RTTO	Kit 3	232.19	278.63
1500x700	S157RTTO	Kit 3	244.79	293.75
1500x760	S1576RTTO	Kit 3	258.47	310.16
1500x800	S158RTTO	Kit 3	258.47	310.16
1500x900	S159RTTO	Kit 3	272.07	326.48
1600x700	S167RTTO	Kit 3	288.40	346.08
1600x800	S168RTTO	Kit 3	288.40	346.08
1600x900	S169RTTO	Kit 3	302.82	363.38
1685x700	S177RTTO	Kit 3	312.43	374.92
1680x760	S1776RTTO	Kit 3	322.05	386.46
1700x800*	S178RTTO	Kit 3	350.41	420.49
1700x900*	S179RTTO	Kit 3	377.44	452.93

TOUCHSTONE

Square Tray

Tray Size	Order Code	Tray Panel Kit	Price £ Exc. VAT	Price £ Inc. VAT
760x760	S76SQTO	Kit 4	78.42	94.10
800x800	S80SQTO	Kit 4	87.86	105.43
900x900	S90SQTO	Kit 4	101.48	121.78

Square Tray Panel Kit – (Including Legs)

Tray Size	Order Code	Tray Panel Kit	Price £ Exc. VAT	Price £ Inc. VAT
1200x900	DRK4	Kit 4	85.10	102.12

Rectangle Tray Panel Kits – (Including Legs)

Tray Size	Order Code	Tray Panel Kit	Price £ Exc. VAT	Price £ Inc. VAT
1700x900	DRK3	Kit 3	85.10	102.12
1200x900	DRK4	Kit 4	85.10	102.12

Waste Complete Only

Order Code	Price £ Exc. VAT	Price £ Inc. VAT
DWAS	20.00	24.00

90mm fast flow waste, includes hair trap and chrome cover.



Please Note: Price and order code does not include waste, waste must be ordered separately.

Quadrant Tray



TOUCHSTONE

Quadrant Tray

Tray Size	Order Code	Tray Panel Kit	Price £ Exc. VAT	Price £ Inc. VAT
800	S80QTO	Kit 2	96.13	115.36
900	S90QTO	Kit 2	107.45	128.94

Quadrant Tray Panel Kits (Including Legs)

Tray Size	Order Code	Tray Panel Kit	Price £ Exc. VAT	Price £ Inc. VAT
900	DRK2	Kit 2	85.10	102.12

Waste Complete Only

Order Code	Price £ Exc. VAT	Price £ Inc. VAT
DWAS	20.00	24.00



90mm fast flow waste, includes hair trap and chrome cover.

Please Note: Price and order code does not include waste, waste must be ordered separately.

Offset Quadrant Tray



TOUCHSTONE

Shown as Left Hand (L)
Right Hand (R) also available

Offset Quadrant Tray

Tray Size	Order Code	Tray Panel Kit	Price £ Exc. VAT	Price £ Inc. VAT
Right Hand				
1000x800	S108QRTO	Kit 1	145.87	175.04
1200x800	S128QRTO	Kit 1	153.55	184.26
1200x900	S129QRTO	Kit 1	181.18	217.42
Left Hand				
1000x800	S108QLTO	Kit 1	145.87	175.04
1200x800	S128QLTO	Kit 1	153.55	184.26
1200x900	S129QLTO	Kit 1	181.18	217.42

This product is handed.
Please choose (L) for Left or (R) for Right when ordering.

Offset Quadrant Tray Panel Kit (Including Legs)

Tray Size	Order Code	Tray Panel Kit	Price £ Exc. VAT	Price £ Inc. VAT
1200x900	DRK1	Kit 1	85.10	102.12

MERLYN

UPSTAND



Features

- ✓ Single skinned with 4 upstands
- ✓ Available with 90mm branded fast flow waste (optional extra)
- ✓ Available with tray panel kits (optional extra)
- ✓ 135mm high with tray panel set (148mm high including upstand)
- ✓ 50mm high (63mm with upstand)

Rectangular Tray Square Tray

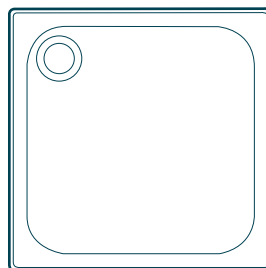

Rectangle Tray

Tray Size	Order Code	Tray Panel Kit	Price £ Exc. VAT	Price £ Inc. VAT
900x760	S976RTUP	Kit 4	164.20	197.04
1000x800	S108RTUP	Kit 4	173.10	207.72
1200x760	S1276RTUP	Kit 4	188.30	225.96
1200x800	S128RTUP	Kit 4	199.60	239.52
1200x900	S129RTUP	Kit 4	214.20	257.04

Square Tray

Tray Size	Order Code	Tray Panel Kit	Price £ Exc. VAT	Price £ Inc. VAT
760	S76SQUP	Kit 4	102.00	122.40
800	S80SQUP	Kit 4	114.20	137.04
900	S90SQUP	Kit 4	164.20	197.04

Tray Panel Kit - Including Legs

Tray Size	Order Code	Tray Panel Kit	Price £ Exc. VAT	Price £ Inc. VAT
1200x900	DRK4	Kit 4	85.10	102.12

Waste Complete Only

Order Code	Price £ Exc. VAT	Price £ Inc. VAT
DWAS	20.00	24.00

Please Note: Price and order code does not include waste, waste must be ordered separately.

90mm fast flow waste, includes hair trap and chrome cover.



Technical Section

We have produced this product section to help you with your purchasing decision. For further information please contact your local stockist, details of which can be found at www.ionicbymerlyn.com

PRODUCT INFORMATION

All products are manufactured in accordance with EN 14428 and utilise toughened safety glass to EN 12150.

All doors feature adjustable wall profiles to compensate for out-of-true walls and have micro adjustment features for fine tuning to obtain a perfect fit and operating action.

Aluminium sections are extruded to BS 1474 from alloys complying with BS 6463 and coated to BS 6464.

All enclosures, wetrooms and panels are Power Shower approved – will retain water under normal showering conditions.

Water retention is maintained in all products under normal showering conditions.

A selection of Ionic enclosures are frameless in design. Spray/mist may escape therefore we would recommend use of these enclosures with tiled floors.

Opened cartons can not be returned. Returns carry a £40 box charge or £60 per unit where the sale is less than 30 days old. Returns over 30 days old will not be accepted.

All products are supplied complete with full installation instructions and the necessary fixings.

Check with your dealer for accurate matching of material samples.

Product descriptions do not imply the use of precious or valuable materials.

Our policy of reviewing product design and development on a regular basis means Merlyn reserve the right to change product specifications and prices without notice.

Only shower enclosures, panels and bath screens and some trays are covered by guarantees. Please contact the Ionic sales team for more details.

Glass shattering and parts subject to wear are not covered by your guarantee.

For full details on all product ranges please contact Ionic Showering.

Trays shown in this catalogue are for illustrative purposes only.

Images are for illustrated purposes only. The colours and finishes shown in the catalogue are as accurate as possible within the limits of the printing process. The positioning of all showering heads in the brochure is for illustrative purposes only.

All descriptions, specifications and particulars contained in this brochure are intended merely to represent a general idea of the products described herein and none of these form part of any contract to give rise to any independent or collateral liability upon the company.

BATH SCREEN INFORMATION

Ionic Bath Screens are not designed to fit on baths with stepped fronts, roll top rims or integral soap dishes.

Fitting of screen on baths which have raised head rests or shapes is not recommended.

There must be no items causing obstruction with the seal and bath, as any of the above may cause leaks.

When choosing your Bath Screen, please ensure that if your bath has bath handles, that they do not interfere with the bath rim area where your screen will be placed.

When choosing an in-swing or folding Bath Screen, please ensure your swing area is not interfering with any brassware or internal shower features. Similarly, when choosing an out-swing, please ensure the out-swing area is free from any obstructions.

The Ionic MB72 Panel Hinged Bath Screen is handed so please ensure you state whether you require a right or left handed configuration when ordering.

Ionic Bath Screens are suitable for standard pressure showers and are not recommended for use with power showers.

It is recommended that the shower head position is situated on the same wall to which the Bath Screen is fixed and in the centre of the shower area.

CLEANING

It is important to clean your Ionic shower door after every use.

Wipe down all the glass and metal parts with a soft cloth.

Do not allow lime scale to build up in hard water areas.

Ensure that any residual water on the glass is removed after every use.

Clean the glass regularly using soapy water.

Do not use abrasive products on any surfaces.

Install the enclosure in a well ventilated area.

For more information on Mersfield Stayclear glass please see page 06 of this brochure.

INFORMATION AND MAINTENANCE

Always read the instructions on the packaging, chrome is vulnerable to acid attack and some strong household cleaners including strong disinfectants, denture cleaners, hair dyes, wine making chemicals and photographic chemicals may contain acid. These materials may have a varying effect on the surface from black spots/streaks (which cannot be removed) to pitting the surface. Contact with these materials should be avoided.

IMPORTANT SHOWER TRAY INFORMATION

Although shower door and enclosure sizes are related to tray sizes it is important to note that most shower trays are tiled down to the rim, often over an "up-stand". The finished installation space may be less than the nominal tray size.

Ionic shower units are made to suit this remaining space.

The guide below may be helpful in taking measurements to determine the shower door or enclosure size required. Dimensions given in this publication are in millimetres, are approximate and may vary with adjustment. They are subject to change without notice.

Please note that when a tray is fitted it is essential that the tray is level before any doors or enclosures are fitted.

Tray upstands: ensure strong and secure joints between shower tray and walls, even in the event of floor settlement. Tiling must be finished over the recessed upstand as shown in the diagram below.

Cleaning: clean after every use with warm soapy water and wipe dry with soft cloth, never use a gritty or abrasive cleaner.

Take the measurements after the tray is installed and the walls are tiled.

Recess Location

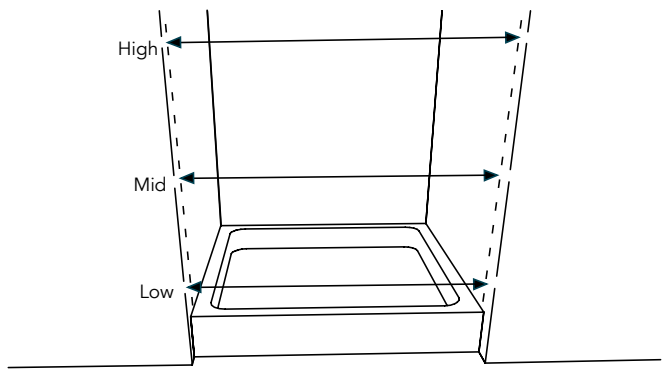

Corner Location

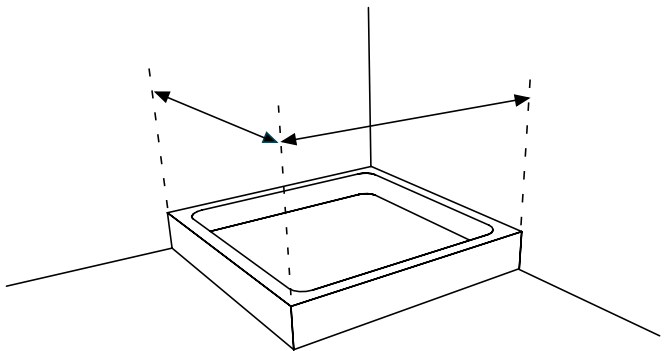

Wall Location

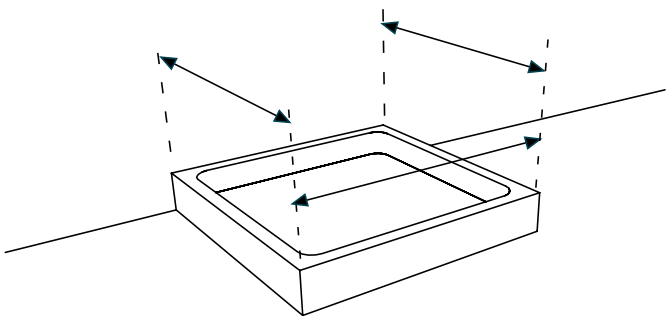

Quadrant Location

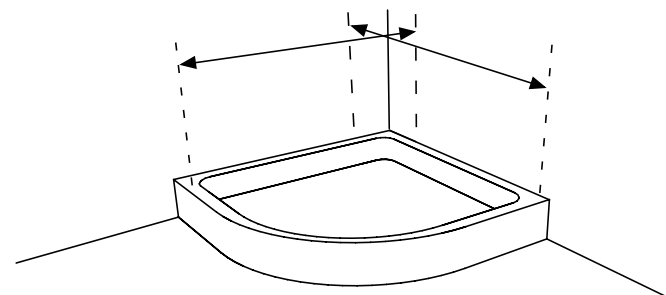

EXTENSION PROFILES

Essence Sliding & Quadrant Doors

Size (H)	Order Code	Price £ Exc. VAT	Price £ Inc. VAT
2000mm	A0114E0	61.70	74.04

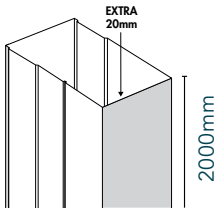

Express Extension Profile

Size (H)	Order Code	Price £ Exc. VAT	Price £ Inc. VAT
1900mm	A0314B0	56.00	67.20

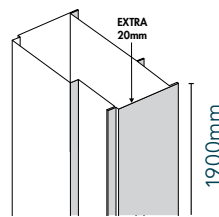

Essence Hinge & Inline Doors

Size (H)	Order Code	Price £ Exc. VAT	Price £ Inc. VAT
2000mm	A0114D0	61.70	74.04

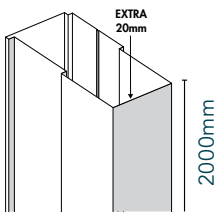

Source Extension Profile

Size (H)	Order Code	Price £ Exc. VAT	Price £ Inc. VAT
1850mm	A1214C0	44.60	53.52

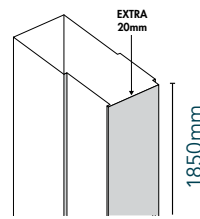

Essence Framed Extension Profile

Size (H)	Order Code	Price £ Exc. VAT	Price £ Inc. VAT
1900mm	DWH14B0	61.70	74.04

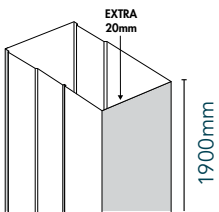

ADDITIONAL INFO IONIC EXPRESS INLINE PANELS

Ionic Express Pivot Door and Inline Panel			
Size	Order Code	Door Size mm	Inline Panel Size mm
650-690	A0306A0	700	-
670-710	A030001H	700	EXT.
710-750	A0306B0	760	-
750-790	A0306D0	800	-
780-840	A030002H	700	150 Inline
840-900	A030003H	700	210 Inline
850-890	A0306E0	900	-
900-960	A030004H	760	210 Inline
950-990	A0306G0	1000	-
940-1000	A030005H	800	210 Inline
980-1040	A030006H	900	150 Inline
1040-1100	A030007H	900	210 Inline
1080-1140	A030008H	1000	150 Inline
1140-1200	A030009H	1000	210 Inline

Ionic Express Bifold Door and Inline Panel			
Size	Order Code	Door Size mm	Inline Panel Size mm
710-750	A0300B0	760	-
750-790	A0300C0	800	-
850-890	A0300D0	900	-
900-960	A030010H	760	210 Inline
950-990	A0300E0	1000	-
940-1000	A030011H	800	210 Inline
980-1040	A030012H	900	150 Inline
1040-1100	A030013H	900	210 Inline
1080-1140	A030014H	1000	150 Inline
1140-1200	A030015H	1000	210 Inline

Ionic Express Sliding Door and Inline Panel			
Size	Order Code	Door Size mm	Inline Panel Size mm
950-990	A0304A0	1000	-
1050-1090	A0304B0	1100	-
1080-1140	A030016H	1000	150 Inline
1140-1200	A030017H	1000	210 Inline
1150-1190	A0304C0	1200	-
1180-1240	A030018H	1100	150 Inline
1240-1300	A030019H	1100	210 Inline
1280-1340	A030020H	1200	150 Inline
1340-1400	A030021H	1200	210 Inline
1350-1390	A0304DH	1400	-
1370-1450	A030022H	1100	150 Inline + 210 Inline
1450-1490	A0304GH	1500	-
1480-1540	A030023H	1400	150 Inline
1540-1600	A030024H	1400	210 Inline
1580-1640	A030025H	1500	150 Inline
1640-1700	A030026H	1500	210 Inline
1650-1690	A0304HH	1700	-
1670-1750	A030027H	1400	150 Inline + 210 Inline
1730-1810	A030028H	1400	210 Inline x 2
1780-1840	A030029H	1700	150 Inline
1840-1900	A030030H	1700	210 Inline

PLEASE NOTE

Prices were correct at time of print, April 2018. V.A.T. at the rate of 20%. E&OE. Due to circumstances beyond our control, prices may be altered including changes to the rate of V.A.T.

Due to our policy of continuous improvement, we reserve the right to amend prices, specifications and designs without prior notice. Images are for illustrated purposes only. The colours and finishes shown in the catalogue are

as accurate as possible within the limits of the printing process. All descriptions, specifications and particulars contained in this brochure are intended merely to represent a general idea of the products described herein and none of these form part of any contract to give rise to any independent or collateral liability upon the company.

MERLYN
IONIC

MERLYN

Unit 8, Purocellsinch Industrial Park, Dublin Road, Kilkenny, Ireland, R95 HP71.

T 0808 1011 429 / F 0808 1011 428

www.merlynshowering.com