

K

KUDOS

showering solutions you can trust

# showering solutions you can trust...

Located on the edge of the beautiful Lake District, KUDOS have been designing and manufacturing innovative, high quality shower products since 1999.

All products are created to deliver the very best in functionality, performance and value. No compromise is made in their production and each are hand built by a skilled team.

All KUDOS products are covered by our Lifetime Guarantee against material or manufacturing defects for your complete peace of mind.

**Great British products from  
a great British company.**

# K

KUDOS



# the collection

by KUDOS



## **pinnacle8** - Shower Doors & Enclosures

p4

Reaching new heights in enclosure design, this stunning new KUDOS **pinnacle8** collection of sliding and hinged doors represents high quality style, functionality and engineering.



## **ultimate** - Walk-in Shower Panels

p12

The most comprehensive and versatile range of shower panels and fixings, the KUDOS **ultimate** collection provides almost limitless options for you to create your perfect walk-in enclosure.



## **original** - Shower Doors & Enclosures

p20

Offering a choice of recess & corner enclosures in straight, bowed & curved styles. With a variety of sliding, pivot and bi-fold door options, there is a KUDOS **original** enclosure to suit everyone.



## **infinite** - Shower Doors & Enclosures

p34

The stunning KUDOS **infinite** range offers a modern, minimalist look with design features that enhance & enrich the range. It is one of the most technically advanced showering enclosure systems available today.



## **Kstone** - Shower Trays

p48

Made from the highest quality materials, including an acrylic capped ABS skin with structural resin bonded stone filler, KUDOS **Kstone** trays provide the perfect foundation for your new shower enclosure.



## **concept** - Shower Trays

p50

Manufactured from the same high quality materials as Kstone, KUDOS **concept** trays are created specially for use with uniquely shaped KUDOS enclosures.

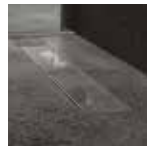

## **aqua4ma** - Wet Room Systems

p52

Featuring both linear or central waste shower decks, the unique **aqua4ma** system by KUDOS uses extruded uPVC panels to provide a total watertight solution for floors and walls.



## **inspire** - Bath Screens

p64

With KUDOS **inspire** bath screens you get the best of both worlds... indulge yourself in a relaxing bath or enjoy an invigorating shower without compromising on style or performance.

for shower enclosures you can trust...

# pinnacle8

by KUDOS

**pinnacle8** is a new range of enclosures and represents new heights in shower design. Featuring 8mm toughened safety glass throughout and treated with Lifeshield™ protective coating for easy cleaning, all products are 2000mm high and covered by a lifetime guarantee against material or manufacturing defects for your complete peace of mind.

The **pinnacle8** collection features Hinged and Sliding Door options to suit both recess and corner installations in sizes ranging from 760mm to 1800mm so there is sure to be a solution to suit you. With concealed fixings throughout, these stylish minimalist doors are both easy to install and stunning to look at.

## Key features are:

- + Hinged and sliding options
- + 8mm toughened safety glass
- + Simple and fast to install
- + 2000mm high
- + Concealed fixings
- + Slimline profile with 20mm wall adjustment
- + Lifetime Guarantee\*
- + Lifeshield™ Glass Protection



\* Guarantee applies to material and manufacturing defects only. See website for full Terms and Conditions.



| Recessed Hinged Door



| Stylish chromed rise & fall hinges



| Elegant, minimalist finger pull



| Optional retro-fit handle





| 800 Hinged Door (L/H) for Recess -

pinnacle8

## Hinged & Sliding Doors for Recessed Installations

### ◀ Hinged Recess Door Options

Door Size	Adjustment mm†	Access mm	Prod. Code LH	Prod. Code RH
760	725-765	505	P8HR76L	P8HR76R
800	765-805	545	P8HR80L	P8HR80R
900	865-905	645	P8HR90L	P8HR90R
1000	965-1005	645	P8HR100L	P8HR100R
1200	1165-1205	645	P8HR120L	P8HR120R
1400	1365-1405	645	P8HR140L	P8HR140R
1500	1465-1505	645	P8HR150L	P8HR150R

### ▼ Sliding Recess Door Options

Door Size	Adjustment mm†	Access mm	Prod. Code
1000	965-1005	375-395	P8SR100
1100	1065-1105	375-395	P8SR110
1200	1165-1205	475-495	P8SR120
1400	1365-1405	575-595	P8SR140
1500	1465-1505	575-595	P8SR150
1600	1565-1605	575-595	P8SR160
1700	1665-1705	575-595	P8SR170
1800	1765-1805	575-595	P8SR180

For full technical details on this product, see pages 10-11.



| 1400 Sliding Door for Recess

pinnacle8

## Hinged Doors for Corner Installations

### ▼ Hinged Corner Door Options

Door Size	Adjustment mm <sup>†</sup>	Access mm	Prod. Code LH	Prod. Code RH	
760	730-750	530	P8HC76L	P8HC76R	
800	770-790	570	P8HC80L	P8HC80R	
900	870-890	670	P8HC90L	P8HC90R	
1000	970-990	670	P8HC100L	P8HC100R	
1200	1170-1190	670	P8HC120L	P8HC120R	
1400	1370-1390	670	P8HC140L	P8HC140R	
1500	1470-1490	670	P8HC150L	P8HC150R	

### ▼ Side Panel Options

Side Panel Size	Prod. Code	
700	P8HC2SP70	
760	P8HC2SP76	
800	P8HC2SP80	
900	P8HC2SP90	
1000	P8HC2SP100	

For full technical details on this product, see pages 10-11.



| 1200 Hinged Door (L/H) for Corner with 800 Side Panel



pinnacle8

## Sliding Doors & Panels for Corner Installations

### ▼ Sliding Corner Door Options

Door Size	Adjustment mm†	Access mm	Prod. Code
1000	970-990	400	P8SC100
1100	1070-1090	400	P8SC110
1200	1170-1190	500	P8SC120
1400	1370-1390	600	P8SC140
1500	1470-1490	600	P8SC150
1600	1570-1590	600	P8SC160
1700	1670-1690	600	P8SC170
1800	1770-1790	600	P8SC180

### ▼ Side Panel Options

Side Panel Size	Adjustment mm†	Prod. Code
700	670-690	P8SC2SP70
760	730-750	P8SC2SP76
800	770-790	P8SC2SP80
900	870-890	P8SC2SP90

For full technical details on this product, see pages 10-11. We recommend the use of a KUDOS Kstone Shower Tray with pinnacle8 enclosures & doors. Details and prices of trays are available on pages 48-49.

### Extra Options

Product	Prod. Code
Angled Stabilising Bracket*	PBSB
Retro Fit Handle*	P8RH
10mm Extension Profile†	P8SOS

\*An optional angled stabilising bracket is available for larger doors if additional stability is required. An optional handle is available if required. Both angled bracket and handle can be retro fitted and only need to be purchased if preferred.

†Please note that all pinnacle8 doors and side panels can be extended in increments of 10mm with a pinnacle8 extension profile. All sizes are nominal.



| 1500 Sliding Door for Corner with 800 Side Panel

### Hinged Recess Door Options

Door Size	Product Code		Dimension mm					
	LH	RH	A	B	C	D	E	F
760	P8HR76L	P8HR76R	725-765	505	168-188	534	26	34
800	P8HR80L	P8HR80R	765-805	545	168-188	574	26	34
900	P8HR90L	P8HR90R	865-905	645	168-188	674	26	34
1000	P8HR100L	P8HR100R	965-1005	645	268-288	674	26	34
1200	P8HR120L	P8HR120R	1165-1205	645	468-488	674	26	34
1400	P8HR140L	P8HR140R	1365-1405	645	668-688	674	26	34
1500	P8HR150L	P8HR150R	1465-1505	645	768-788	674	26	34

Door Height - 2000mm – excluding tray

HINGED DOORS ARE SUPPLIED LEFT HAND (as shown in diagram) OR RIGHT HAND

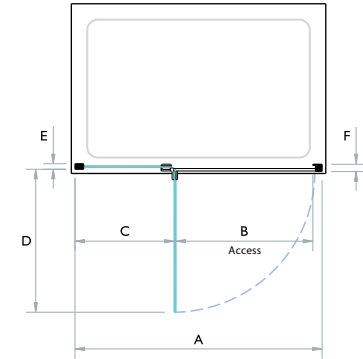

### Sliding Recess Door Options

Door Size	Product Code	Dimension mm				
		A	B	C	D	E
1000	P8SR100	965-1005	375-395	452-472	26	37
1100	P8SR110	1065-1105	375-395	552-572	26	37
1200	P8SR120	1165-1205	475-495	552-572	26	37
1400	P8SR140	1365-1405	575-595	652-672	26	37
1500	P8SR150	1465-1505	575-595	752-772	26	37
1600	P8SR160	1565-1605	575-595	852-872	26	37
1700	P8SR170	1665-1705	575-595	952-972	26	37
1800	P8SR180	1765-1805	575-595	1052-1072	26	37

Door Height - 2000mm – excluding tray

SLIDING DOORS CAN BE FITTED TO OPEN EITHER LEFT HAND OR RIGHT HAND

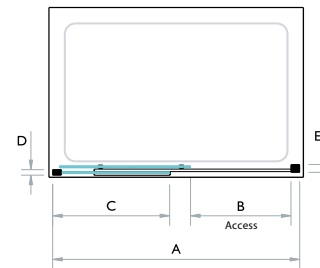

# Hinged & Sliding Doors for Corner Installations

## Hinged Corner Door Options

Door Size	Product Code		Dimension mm				
	LH	RH	A	B	C	D	E
760	P8HC76L	P8HC76R	730-750	530	168-188	555	26
800	P8HC80L	P8HC80R	770-790	570	168-188	595	26
900	P8HC90L	P8HC90R	870-890	670	168-188	695	26
1000	P8HC100L	P8HC100R	970-990	670	268-288	695	26
1200	P8HC120L	P8HC120R	1170-1190	670	468-488	695	26
1400	P8HC140L	P8HC140R	1370-1390	670	668-688	695	26
1500	P8HC150L	P8HC150R	1470-1490	670	768-788	695	26

Door Height - 2000mm – excluding tray

HINGED DOORS ARE SUPPLIED LEFT HAND (as shown in diagram) OR RIGHT HAND

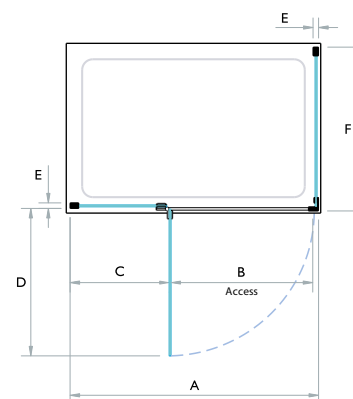

Side Panel Size	Product Code	Dimension mm
		F
700	P8HC2SP70	670-690
760	P8HC2SP76	730-750
800	P8HC2SP80	770-790
900	P8HC2SP90	870-890
1000	P8HC2SP100	970-990

## Sliding Corner Door Options

Door Size	Product Code	Dimension mm			
		A	B	C	D
1000	P8SC100	970-990	400	452-472	26
1100	P8SC110	1070-1090	400	552-572	26
1200	P8SC120	1170-1190	500	552-572	26
1400	P8SC140	1370-1390	600	652-672	26
1500	P8SC150	1470-1490	600	752-772	26
1600	P8SC160	1570-1590	600	852-872	26
1700	P8SC170	1670-1690	600	952-972	26
1800	P8SC180	1770-1790	600	1052-1072	26

Door Height - 2000mm – excluding tray

SLIDING DOORS CAN BE FITTED TO OPEN EITHER LEFT HAND OR RIGHT HAND

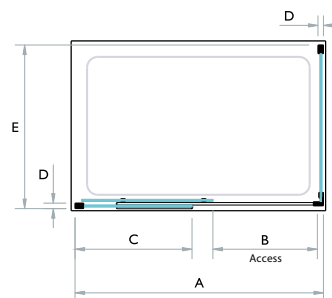

Side Panel Size	Product Code	Dimension mm
		E
700mm	P8SC2SP70	670-690
760mm	P8SC2SP76	730-750
800mm	P8SC2SP80	770-790
900mm	P8SC2SP90	870-890

for walk-in shower panels you can trust...

# ultimate

by KUDOS

KUDOS **ultimate** Shower Panels offer the ultimate in choice and versatility.

The extensive range of toughened safety glass panels are available in both 8 & 10mm glass as well as two sizes of stunning 8mm curved glass options. With ultimate you can create a showering area to suit virtually any situation and with a choice of fixings, you are certain to find the solution needed to create your perfect shower.

With five special metal finishes in addition to the standard Silver/Chrome options you can even complement or match other fittings for the ultimate in individuality.

Suitable for shower trays as well as tiled wet-floors, KUDOS **ultimate** also offer fixed or hinged retro-fit Deflector Panels.

All ultimate products are covered by the KUDOS Lifetime Guarantee<sup>†</sup> for complete peace of mind.

## Key features are:

- + Extensive range of Panel sizes in both 8 & 10mm
- + Option of two sizes of stunning 8mm curved glass Panels
- + Crystal clear corner seal to join glass to glass
- + Suitable for fitting to shower trays or directly onto wet-floors
- + Optional retro-fit Deflector Panels
- + Overall 1985mm high including fittings
- + Choice of high quality fixings to suit all situations
- + Choice of silver or five special finishes
- + Lifeshield easy-clean glass protection
- + Lifetime guarantee\*



<sup>†</sup>Guarantee applies to material and manufacturing defects only. See website for full Terms and Conditions.





| Corner Enclosure with Standard Fixing Kits



| Three Sided Enclosure



| Recess Enclosure with Standard Fixing Kit



| Curved Glass Corner Enclosure Package c/w Concept Tray

8 & 10mm  
FLAT GLASS PANELS



Three Sided Enclosure with Standard Fixing Kits on Kstone Tray





## ultimate Flat Glass Options

The **ultimate** system offers 11 panel sizes in a choice of either 8 or 10mm and can be configured to suit virtually any situation.

With a choice of fittings and special finishes to match or complement your decor **ultimate** has it all.

Walk through Panel with Standard Fixing Kits & 2 Hinged Deflector Panels



## ultimate Curved Glass Options

In addition to the extensive range of flat panels the **ultimate** collection also offers two sizes of curved Panels. These 1000mm & 1200mm 8mm toughened safety glass Panels are suitable for both corner and recess configurations.

Designed to fit a dedicated bowed fronted **concept** tray which is supplied in the curved Panel packages. Panels may be purchased separately but unless the wet floor area is shaped to match the curve of the screen drainage may be impaired.

Recess Enclosure with Standard Fixing Kit



1000 Curved Glass Panel on 1500 x 700 Bowed Fronted Shower Tray

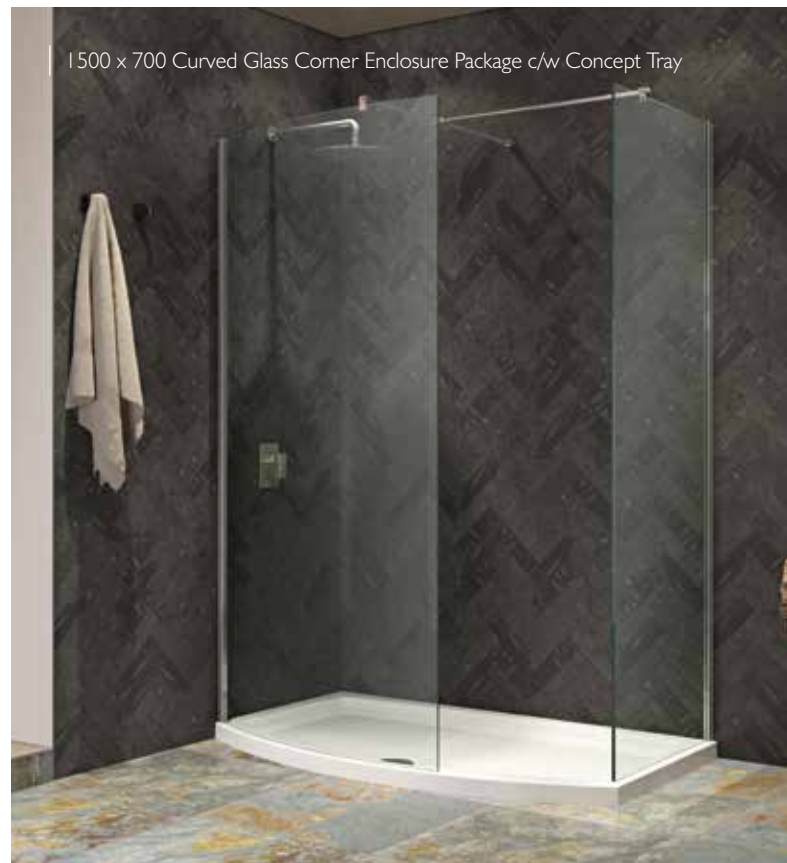

1500 x 700 Curved Glass Corner Enclosure Package c/w Concept Tray

# ultimate

## Deflector Panels

Designed to contain overspray and splashing within your designated showering area, the **ultimate** system offers a choice of either fixed or Hinged Deflector Panels, these can be retro-fitted so only need to be purchased if found necessary.

Enjoy the pleasure and appearance of a walk-in shower even where space is at a premium. With the ability to fit a Deflector Panel it is now possible to create a functional and stunning enclosure even in the smallest spaces.

### Hinged Deflector Panel

Example of Hinged Deflector Panel fitted in recess. Hinged Deflectors can be fitted with either Standard, Ceiling or Corner stabilising bars.

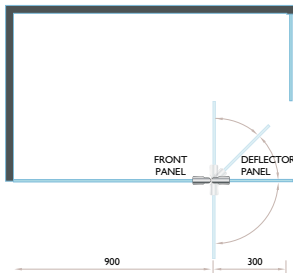
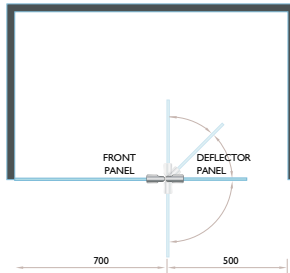

In a corner installation a longer front panel can be fitted with a shorter side panel maintaining access of 500mm whilst the hinged Deflector Panel will contain any overspray.

### Fixed Deflector Panel

The Fixed Deflector Panel is supplied with fittings to connect to standard stabilising bars only. *N.B. This product cannot be used with ceiling or angled stabilising bars.*

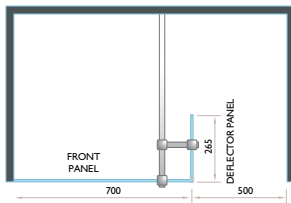

700 Flat Glass Panel with 300 LH Hinged Deflector Panel on a 1200 x 800 shower tray



Walk Through Panel with 2 Hinged Deflector Panels



## ultimate Special Finishes

Create your individual style with **ultimate** Special Finishes. Complement or match other bathroom fittings with a choice of Matt Black, Brushed or Bright Nickel and Brushed or Polished Gold.



Brushed Nickel (BRN)



Bright Nickel (BN)



Brushed Gold (BRG)

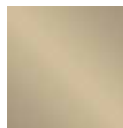

Polished Gold (PG)



Matt Black (MBK)

Matt black features contrasting chrome wall fitting and glass clamp.

Fixed Deflector Panels are supplied with fittings to connect to both recess or corner configurations



Black Finish Fixings



# ultimate

## Configurations

The variety of panels sizes, fitting options and the ability to join glass to glass with our unique crystal clear corner seal, means that with **ultimate** you can create virtually any configuration in an almost limitless range of sizes. Shown below are the most typical installation styles with a list of items required to create each option.



### Recess

- 1 x Glass Panel
- 1 x Wall Post
- 1 x Front Panel Fixing Kit\*

\*Standard, Ceiling or Angled



### Corner

- 1 x Glass Panel (Front)
- 1 x Glass Panel (Side)
- 2 x Wall Posts
- 1 x Front Panel Fixing Kit\*
- 1 x Side Panel Fixing Kit\*

\*Standard, Ceiling or Angled



### Corner (Glass to glass)

- 1 x Glass Panel (Front)
- 1 x Glass Panel (Side)
- 1 x Wall Post
- 1 x Front Panel Fixing Kit\*
- 1 x Corner Seal

\*Standard or Ceiling only



### Walk Through

- 1 x Glass Panel
- 2 x Front Panel Fixing Kits\*

\*Standard or Ceiling only



### Open Ended

- 1 x Glass Panel
- 1 x Wall Post
- 1 x Front Panel Fixing Kit\*

\*Standard, Ceiling or Angled



### Three Sided

- 1 x Glass Panel (Front)
- 2 x Glass Panels (Side)
- 2 x Wall Posts
- 1 x Front Panel Fixing Kit\*
- 1 x Side Panel Fixing Kit\*
- 1 x Corner Seal

\*Standard or Ceiling only

When choosing your panel sizes we recommend allowing access of approx. 500mm.

# ultimate

## Fixing Kits

We recommend the use of the standard fixing kit for maximum stability of **ultimate** Shower Panels. Front and side panel fixing kits are supplied with a 1000mm straight stabilising bar, a 1500mm bar is available if required.



## Product Codes & Pricing

Shower Panels <sup>#</sup>	Product Code 8mm Glass	Product Code 10mm Glass
400 Glass Panel	5WP400	10WP400
500 Glass Panel	5WP500	10WP500
600 Glass Panel	5WP600	10WP600
700 Glass Panel	5WP700	10WP700
760 Glass Panel	5WP760	10WP760
800 Glass Panel	5WP800	10WP800
900 Glass Panel	5WP900	10WP900
1000 Glass Panel	5WP1000	10WP1000
1100 Glass Panel	5WP1100	10WP1100
1200 Glass Panel	5WP1200	10WP1200
1400 Glass Panel	5WP1400	10WP1400
255mm Fixed Deflector Panel	5WPDEFP	10WPDEFP
300mm Hinged Deflector Panel†	5WPHINDP	10WPHINDP
400mm Hinged Deflector Panel†	5WPHINDP400	10PHINDP400
Glass to Glass Corner Seal	5WPCS	10WPCS
1000mm Curved Glass Panel	5WPCV1000	-
1200mm Curved Glass Panel	5WPCV1200	-
300mm Curved Glass Deflector Panel†	5WPCVHINDP	-

## Special Finishes

Fittings	Product Code	Price Std. Finish	Matt Black (MBK)	Brushed Nickel (BRN)	Bright Nickel (BN)	Brushed Gold (BRG)	Polished Gold (PG)
Wall Post	10WPK						
Wall Post for Curved Glass Panels	10WPKCV						
Front Panel Fixing Kit	10WPFPFK						
Side Panel Fixing Kit	10WSPPFK						
Ceiling Fixing Kit	10WPGC						
300mm Angled Fixing Kit	10WPGW30						
500mm Angled Fixing Kit	10WPGW50						
1500mm Extension Fixing Bar	10WP1500SR						
255mm Fixed Deflector Panel - special finish options			-				
300mm Hinged Deflector Panel - special finish options			-				
400mm Hinged Deflector Panel - special finish options			-				
300mm Curved Glass Deflector Panel - special finish options			-				

Notes: † Hinged deflector panels are 'handed', please suffix codes with L/H or R/H.

\*\*Matt black rails and wall posts are supplied with Chrome fittings.

#Sizes shown are nominal. All panels are undersized by 45mm to allow for tiling when fitting to shower trays.

## Complete Packages - Flat Glass

**ultimate** packages offer a simple way to order the two most popular configurations as a complete package including a KUDOS **Kstone** tray. See pages 48-49 for tray information.



### Recess Package includes:

- 1 x Glass Panel
- 1 x Wall Post
- 1 x Front Panel Fixing Kit
- 1 x Kstone Shower Tray
- 1 x Hi-Flow 90mm Waste

### Corner Package includes:

- 1 x Glass Panel (Front)
- 1 x Glass Panel (Side)
- 2 x Wall Posts
- 1 x Front Panel Fixing Kit
- 1 x Side Panel Fixing Kit
- 1 x Kstone Shower Tray
- 1 x Hi-Flow 90mm Waste

Note: \* In order to maintain 500mm access a 700mm panel is supplied to suit a 1200mm tray. Given the limited spray protection, a deflector panel may be required.

Recess Option Tray Sizes	Recess Packages inc. tray, waste and trap		Corner Packages inc. tray, waste and trap			
	8mm Glass Thickness	10mm Glass Thickness	8mm Glass Thickness	Price	10mm Glass Thickness	
Tray Width	Product Code	Product Code	Product Code		Product Code	
1200 x 700*	7WIR1270	10WIR1270	7WIC1270		10WIC1270	
1200 x 800*	7WIR1280	10WIR1280	7WIC1280		10WIC1280	
1200 x 900*	7WIR1290	10WIR1290	7WIC1290		10WIC1290	
1400 x 700	7WIR1470	10WIR1470	7WIC1470		10WIC1470	
1400 x 800	7WIR1480	10WIR1480	7WIC1480		10WIC1480	
1400 x 900	7WIR1490	10WIR1490	7WIC1490		10WIC1490	
1500 x 700	7WIR1570	10WIR1570	7WIC1570		10WIC1570	
1500 x 800	7WIR1580	10WIR1580	7WIC1580		10WIC1580	
1500 x 900	7WIR1590	10WIR1590	7WIC1590		10WIC1590	
1600 x 700	7WIR1670	10WIR1670	7WIC1670		10WIC1670	
1600 x 800	7WIR1680	10WIR1680	7WIC1680		10WIC1680	
1600 x 900	7WIR1690	10WIR1690	7WIC1690		10WIC1690	
1700 x 700	7WIR1770	10WIR1770	7WIC1770		10WIC1770	
1700 x 800	7WIR1780	10WIR1780	7WIC1780		10WIC1780	
1700 x 900	7WIR1790	10WIR1790	7WIC1790		10WIC1790	

## Complete Packages - Curved Glass

Tray Option	Recess Packages inc. tray, waste & trap		Corner Packages inc. tray, waste & trap	
	8mm Glass Thickness		8mm Glass Thickness	
Tray Size	Product Code		Product Code	
1500 x 700	7WIR15CV		7WIC15CV	
1700 x 700	7WIR17CV		7WIC17CV	

## Complete Packages - Special Finishes

Complete Package Special Finishes (Code)	Matt Black (MBK)	Brushed Nickel (BRN)	Bright Nickel (BN)	Brushed Gold (BRG)	Polished Gold (PG)
Recess					
Corner					

for shower enclosures you can trust...

# original

by KUDOS

Often imitated, seldom matched but never surpassed, KUDOS **original** doors and enclosures have set the standard in showering excellence, with superb engineering, design and unbeatable value for money being the hallmark of the brand.

Offering a choice of recess and corner enclosures in straight, bowed and curved styles as well as a variety of sliding, pivot and bi-fold door options, there is a KUDOS **original** enclosure to suit everyone.

## Key features are:

- + Nylok™ frame levelling system
- + Concealed wall post fixings
- + Adjustment for out-of-true walls
- + Highly polished metal finish
- + Suitable for use with power showers†
- + Toughened safety glass with Lifeshield™ protection
- + KUDOS Sliding Doors feature stainless steel roller bearings for ultra smooth action
- + KUDOS Pivot Doors feature Nylok™ and stainless steel pivot mechanism with individual adjustment for precise door closure
- + Lifetime Guarantee\*



\* Guarantee applies to material and manufacturing defects only.  
† Assuming shower head is positioned appropriately for normal shower use.  
See website for full Terms and Conditions.





| 910 Curved Enclosure with Side Access Sliding Door

## original Straight Sliding Doors and Enclosures

The KUDOS **original** Sliding Doors can be used in a recess or to create a corner enclosure with the addition of a side panel.

All KUDOS Sliding Doors feature a release mechanism for easy cleaning.

- + 6mm toughened safety glass on Straight Sliding Doors, 5mm on Corner Sliding Doors both with Lifeshield™ protection
- + Sliding panel release mechanism for easy cleaning
- + Stainless steel roller bearings for smooth opening action
- + Left or right hand opening
- + Generous 1850mm door height

For full technical details on this product, see pages 30-33. We recommend the use of a KUDOS **Kstone** shower tray with **original** Straight Sliding Doors and Enclosures. Details and prices of corresponding tray sizes are available on pages 48-49.



| 1200 Straight Sliding Door with 800 Side Panel



| 800 Corner Access Enclosure

Enclosure Size Options	Product Code	Adjustment mm			Access Width mm
		Recess Door Only	Corner Door + 1 side	Corner Enclosure	
760 Corner Access	3CS76S	-	-	725-745	380
800 Corner Access	3CS80S	-	-	765-785	410
1000 Straight	3SD100S	945-985	972-992	-	350
1100 Straight	3SD110S	1045-1085	1072-1092	-	400
1200 Straight	3SD120S	1145-1185	1172-1192	-	450
1400 Straight	3SD140S	1345-1385	1372-1392	-	550
1500 Straight	3SD150S	1445-1485	1472-1492	-	550
1600 Straight	3SD160S	1545-1585	1572-1592	-	550
1700 Straight	3SD170S	1645-1685	1672-1692	-	550

Side Panel Size Options	Product Code	Adjustment mm
700 Standard Side Panel	3SP70S	672-687
760 Standard Side Panel	3SP76S	732-747
800 Standard Side Panel	3SP80S	772-787
900 Standard Side Panel	3SP90S	872-887



| 1200 Bowed Sliding Door with 700 Special Side Panel

Enclosure Size Options	Product Code	Adjustment mm		Access Width mm
		Recess	Corner	
1200 Bowed Sliding Door	3BOW120S	1145-1175	1164-1180	470
1500 Bowed Sliding Door	3BOWS150	1445-1475	1464-1480	583
1700 Bowed Sliding Door	3BOWS170	1630-1660	1649-1665	678

Side Panel Size Options	Product Code	Adjustment mm Corner
700 Special Side Panel for use with all Bowed Sliding Doors	3SPB70S	685-700

For full technical details on this product, see pages 30-33. The unique shape of **original** Bowed Sliding Doors require a matching KUDOS **concept** shower tray. See pages 50-51 for more information.

Tray Options	Product Code
1200 x 700	DB120W
1500 x 700	DB150W
1700 x 700	DB170W

## original Bowed Sliding Doors and Enclosures

Spacious and comfortable showering is guaranteed with a KUDOS Bowed Sliding Door Enclosure. Whilst requiring only 700mm of end wall space, these enclosures provide extra space just where you need it and make a perfect replacement for a standard bath.

- + 5mm toughened safety glass with Lifeshield™ protection
- + Sliding panel release mechanism for easy cleaning
- + Stainless steel roller bearings for smooth opening action
- + Left or right hand opening
- + Generous 1850mm door height

| All Original Doors and Panels can be extended in increments of 15mm with a door or panel extension post.



| 1200 Bowed Sliding Door in Recess

## original Curved Corner Enclosures with Sliding Doors

As with all KUDOS **original** Sliding Doors, these products feature a unique release mechanism to allow easy cleaning between panels.

The elegant full curve shape of the KUDOS Curved Corner Enclosure provides generous showering area yet require minimal wall space for fitting.

- + 5mm toughened safety glass with Lifeshield™ glass protection
- + Sliding panel release mechanism for easy cleaning
- + Stainless steel roller bearings for smooth opening action
- + Left or right hand opening
- + Generous 1850mm door height



910 Curved Enclosure with Side Access



910 Curved Enclosure with Centre Access

Enclosure Size Options	Product Code	Adjustment mm	Access Width mm
810 Curved Enclosure - Centre Access	3CD81S	780-795	445
810 Curved Enclosure - Side Access	3SCD81S	780-795	480
910 Curved Enclosure - Centre Access	3CD91S	880-895	530
910 Curved Enclosure - Side Access	3SCD91S	880-895	575
1000 Curved Enclosure - Side Access	3SCD100S	970-985	655

For full technical details on this product, see pages 30-33. The unique shape of **original** Curved Corner Enclosures require a matching KUDOS **concept** shower tray. See pages 50-51 for more information.

Tray Options	Product Code
810 x 810	DC81W
910 x 910	DC91W
1000 x 1000	DC100W





| 1000 Offset Curved Enclosure with Side Access

## original Offset Curved Corner Enclosures with Sliding Doors

With all the features of the Curved Corner Enclosure, these ingenious products provide ideal space saving solutions whilst offering deceptively large showering areas. Requiring just 658mm along its short edge, the 1000 offset can be easily accommodated in most bathrooms even where a door or window restricts available wall space. Extending out to 795mm and measuring up to 985mm at the widest point, this offset enclosure provides the comfort of a large enclosure in a relatively small space and is available in either centre or side access for maximum versatility.

The 1200 Offset requires wall space of just 1165 x 728mm whilst the 1270 Offset requires 1185 x 819mm. Both versions are available in side access only and can be fitted to open either left or right hand.

- + 5mm toughened safety glass with Lifeshield™ protection
- + Sliding panel release mechanism for easy cleaning
- + Stainless steel roller bearings for smooth opening action
- + Left or right hand opening
- + Generous 1850mm door height

Enclosure Size Options	Product Code	Adjustment mm	Access Width mm
1000 Offset Curved Enclosure - Centre Access	3CDOS108S	970-985 / 780-795	530
1000 Offset Curved Enclosure - Side Access	3SCDOS108S	970-985 / 780-795	575
1200 Offset Curved Enclosure	3SCDOS129S	1169-1184 / 880-895	672
1270 Offset Curved Enclosure	3SCDOS91S	1245-1260 / 880-895	575

For full technical details on this product, see pages 30-33. The unique shape of **original** Offset Curved Corner Enclosures require a matching KUDOS **concept** shower tray. See pages 50-51 for more information.

Tray Options	Product Code
1000 x 810	DCOS108W
1200 x 910	DCOS129W
1270 x 910	DCOSW

All Original Doors and Panels can be extended in increments of 15mm with a door extension post.



| 1270 Offset Curved Enclosure

## original Straight Pivot Doors and Enclosures

Simplicity and elegance, coupled with superb engineering, ensures KUDOS Straight Pivot Doors and Enclosures offer a stylish solution to suit most bathrooms. With sizes ranging from 760 to 1200 there is sure to be a KUDOS Straight Pivot to meet your needs.

- + 6mm toughened safety glass with Lifeshield™ protection
- + Nylok™ & stainless steel pivot mechanism
- + Pivot adjustment for precise door closure
- + Left or right hand opening
- + Generous 1850mm door height

Enclosure Size Options	Product Code	Adjustment mm		Access Width mm
		Recess	Corner	
760 Pivot	3PD76S	705-745	732-752	506
800 Pivot	3PD80S	745-785	772-792	546
900 Pivot	3PD90S	845-885	872-892	646
1000 Pivot Wide	3PW100S	945-985	972-992	506
1100 Pivot Wide	3PW110S	1045-1085	1072-1092	546
1200 Pivot Wide	3PW120S	1145-1185	1172-1192	646

For full technical details on this product, see pages 30-33. We recommend the use of a KUDOS **Kstone** shower tray with **original** Straight Pivot Doors and Enclosures. Details and prices of corresponding tray sizes are available on pages 48-49.



Side Panel Size Options	Product Code	Adjustment mm
700 Standard Side Panel	3SP70S	672-687
760 Standard Side Panel	3SP76S	732-747
800 Standard Side Panel	3SP80S	772-787
900 Standard Side Panel	3SP90S	872-887



800 Bowed Pivot with 800 Special Side Panel

## original Bowed Pivot Doors and Enclosures

Spacious and comfortable showering is guaranteed with a KUDOS Bowed Pivot Door Enclosure. These doors can be fitted in a recess or combined with the KUDOS 700 special side panel to create a corner enclosure and is ideal for fitting where a door or window restricts the amount of available wall space.

- + 6mm toughened safety glass with Lifeshield™ protection
- + Nylok™ & stainless steel pivot mechanism
- + Pivot adjustment for precise door closure
- + Built in towel-rail
- + Left or right hand opening
- + Generous 1850mm door height

Enclosure Size Options	Product Code	Adjustment mm		Access Width mm
		Recess	Corner	
800 Bowed Pivot Door	3BPD80S	755-785	774-790	550
900 Bowed Pivot Door	3BPD90S	855-885	874-890	650

Side Panel Size Options	Product Code	Adjustment mm
800 Special Side Panel for use with 800 & 900 Bowed Door	3SPB80S	785-800

For full technical details on this product, see pages 30-33. The unique shape of **original** Bowed Pivot Doors require a matching KUDOS **concept** shower tray. See pages 50-51 for more information.

Tray Options	Product Code
800 x 800	DB80W
900 x 800	DB90W

All Original Doors and Panels can be extended in increments of 15mm with a door extension post.



# original Bi-fold Doors and Enclosures

The full length handle provides easy opening whilst the concealed magnetic closure gives a perfect seal for use with invigorating power showers. Even in the tightest of spaces the inward folding KUDOS Bi-fold won't cramp your style.

Available in 760, 800 and 900 widths and suitable for use with 760, 800 or 900 Side Panels to create a corner enclosure. For full technical details on this product, see pages 30-33.

Enclosure Size Options	Product Code	Adjustment mm		Access Width mm
		Recess	Corner	
760 Bi-fold	3BF76S	705-745	732-752	545
800 Bi-fold	3BF80S	745-785	772-792	585
900 Bi-fold	3BF90S	845-885	872-892	685

Side Panel Size Options	Product Code	Adjustment mm
700 Standard Side Panel	3SP70S	672-687
760 Standard Side Panel	3SP76S	732-747
800 Standard Side Panel	3SP80S	772-787
900 Standard Side Panel	3SP90S	872-887

All Original Doors and Panels can be extended in increments of 15mm with a door extension post. See pages 48-49 for details of corresponding **Kstone** Trays.



800 Bi-fold for Recess





| 800 Bi-fold Corner with Side Panel

## original Enclosure Panels

KUDOS **original** Panels are designed to fit with the majority of KUDOS **original** Doors, enabling you to create a corner enclosure. Available in standard widths of 700, 760, 800 and 900. For Bowed Doors there are special 700 and 800 width Panels.

All Panels have a generous 1850mm height and feature toughened safety glass with Lifeshield™ protection.

+ 4mm toughened safety glass with Lifeshield™ protection

Size Options	Product Code	Adjustment mm
700 Standard Side Panel	3SP70S	672-687
760 Standard Side Panel	3SP76S	732-747
800 Standard Side Panel	3SP80S	772-787
900 Standard Side Panel	3SP90S	872-887
700 Special Side Panel for use with 1200, 1500 & 1700 Bowed Sliding Doors	3SPB70S	685-700
800 Special Side Panel for use with 800 & 900 Bowed Pivot Doors	3SPB80S	785-800

Wall Profiles	Product Code
15mm Wall profile extension for Door	SOSDS
15mm Wall profile extension for Panel	SOSPS

# original

## Straight Sliding Doors and Enclosures

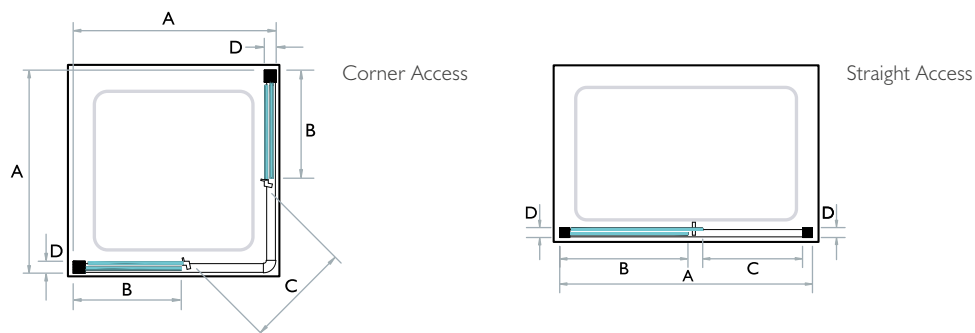

Size Options	Product Code	Adjustment mm			Dimension mm		
		Recess Door Only	Corner Door + 1 side	Corner Enclosure	B	C	D
		A	A	A			
760 Corner Access	3CS76S	-	-	725-745	390-410	380	45
800 Corner Access	3CS80S	-	-	765-785	410-430	410	45
1000 Straight	3SD100S	945-985	972-992	-	480-500	350	45
1100 Straight	3SD110S	1045-1085	1072-1092	-	530-550	400	45
1200 Straight	3SD120S	1145-1185	1172-1192	-	580-600	450	45
1400 Straight	3SD140S	1345-1385	1372-1392	-	680-700	550	45
1500 Straight	3SD150S	1445-1485	1472-1492	-	780-800	550	45
1600 Straight	3SD160S	1545-1585	1572-1592	-	880-900	550	45
1700 Straight	3SD170S	1645-1685	1672-1692	-	980-1000	550	45

Door Height - 1850mm – excluding tray

STRAIGHT SLIDING DOORS CAN BE FITTED TO OPEN EITHER LEFT HAND OR RIGHT HAND

## Bowed Sliding Doors and Enclosures

Size Options	Product Code	Adjustment mm		Dimension mm			
		Recess Door Only	Corner Door + 1 side	B	C	D	E
		A	A				
1200 Bowed Sliding Door	3BOW120S	1145-1175	1164-1180	583-598	470	52	136
1500 Bowed Sliding Door	3BOWS150	1445-1475	1464-1480	757-772	583	52	171
1700 Bowed Sliding Door	3BOWS170	1630-1660	1649-1665	850-865	678	52	194

Door Height - 1850mm – excluding tray

BOWED DOORS CAN BE FITTED TO OPEN EITHER LEFT HAND OR RIGHT HAND

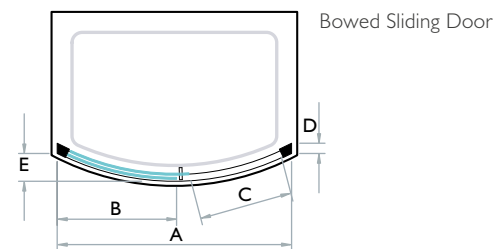

## Curved Corner Enclosures with Sliding Doors

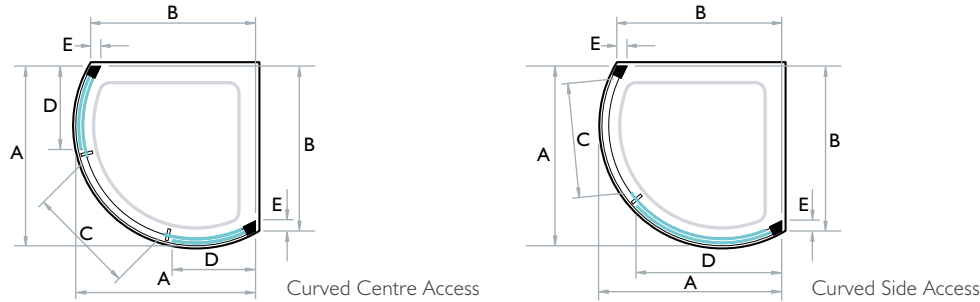

Size Options	Product Code	Adjustment mm Corner Enclosure	Dimension mm				
		A	B	C	D	E	
810 Curved - Centre Access	3CD81S	780-795	750-765	445	352-367	50	
810 Curved - Side Access	3SCD81S	780-795	750-765	480	602-617	50	
910 Curved - Centre Access	3CD91S	880-895	805-820	530	405-420	52	
910 Curved - Side Access	3SCD91S	880-895	805-820	575	707-722	52	
1000 Curved - Side Access	3SCD100S	970-985	835-850	655	798-813	58	

Door/Enclosure Height - 1850mm – excluding tray

SIDE ACCESS ENCLOSURES CAN BE FITTED TO OPEN EITHER LEFT HAND OR RIGHT HAND

## Offset Curved Corner Enclosures with Sliding Doors

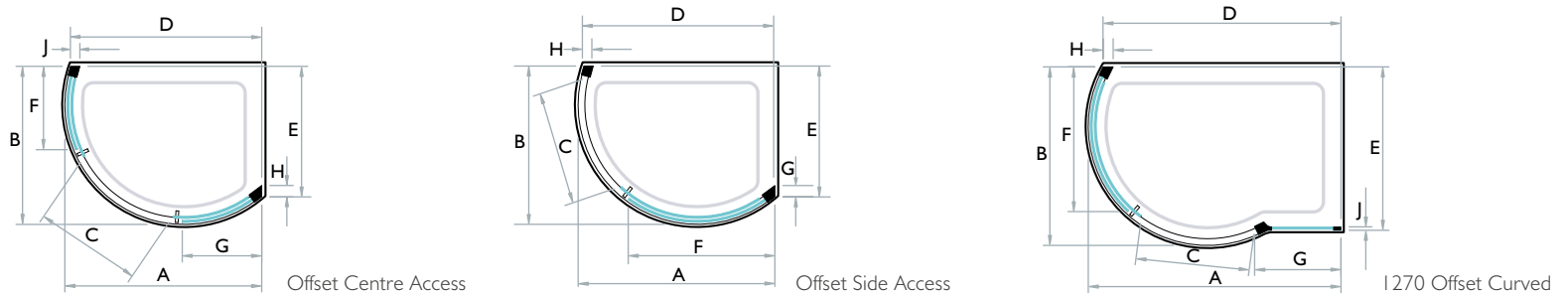

Size Options	Product Code	Adjustment mm Corner Enclosure	Dimension mm							
		A	B	C	D	E	F	G	H	J
1000 Offset Curved - Centre Access	3CDOS108S	970-985	780-795	530	943-958	643-658	423-438	406-421	58	50
1000 Offset Curved - Side Access	3SCDOS108S	970-985	780-795	575	943-958	643-658	717-732	58	50	-
1200 Offset Curved	3SCDOS129S	1169-1184	880-895	672	1150-1165	713-728	853-868	58	45	-
1270 Offset Curved	3SCDOS91S	1245-1260	880-895	575	1170-1185	804-819	712-727	425-440	52	17

Door/Enclosure Height - 1850mm – excluding tray

SIDE ACCESS ENCLOSURE DOORS CAN BE FITTED TO OPEN EITHER LEFT HAND OR RIGHT HAND

## Straight Pivot Doors and Enclosures

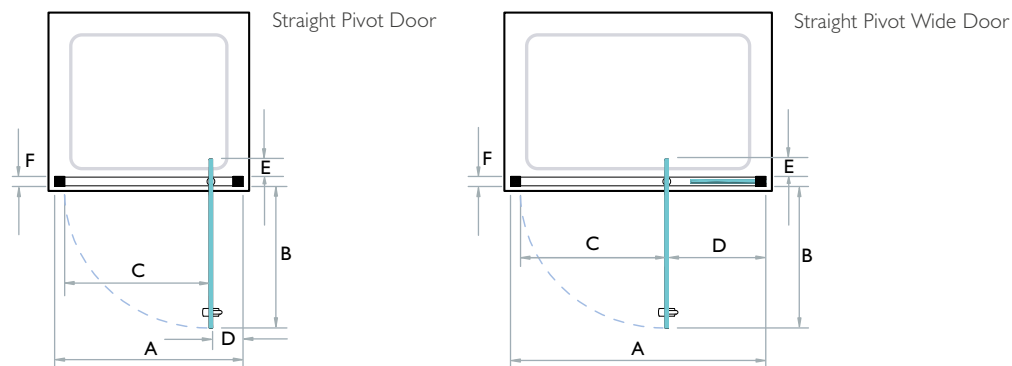

Size Options	Product Code	Adjustment mm		Dimension mm				
		Recess Door Only	Corner Door + 1 side	B	C	D	E	F
		A	A					
760 Pivot	3PD76S	705-745	732-752	493	506	140-160	78	45
800 Pivot	3PD80S	745-785	772-792	533	546	140-160	78	45
900 Pivot	3PD90S	845-885	872-892	633	646	140-160	78	45
1000 Pivot Wide	3PWI00S	945-985	972-992	493	506	380-400	78	45
1100 Pivot Wide	3PWI10S	1045-1085	1072-1092	533	546	440-460	78	45
1200 Pivot Wide	3PWI20S	1145-1185	1172-1192	633	646	440-460	78	45

Door Height - 1850mm – excluding tray

ALL STRAIGHT PIVOTS CAN BE FITTED TO OPEN EITHER LEFT HAND OR RIGHT HAND

## Bowed Pivot Doors and Enclosures

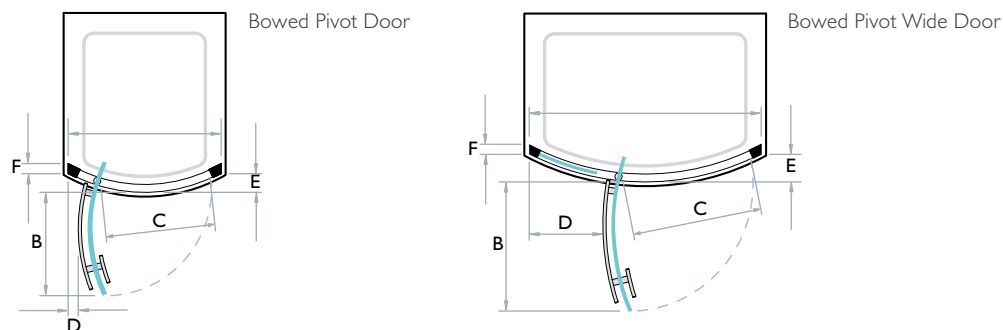

Size Options	Product Code	Adjustment mm		Dimension mm				
		Recess Door Only	Corner Door + 1 side	B	C	D	E	F
		A	A					
800 Bowed Pivot Door	3BPD80S	755-785	774-790	508	550	50-65	92	50
900 Bowed Pivot Door	3BPD90S	855-885	874-890	598	650	50-65	103	50

Door/Enclosure Height - 1850mm – excluding tray

ALL BOWED PIVOTS CAN BE FITTED TO OPEN EITHER LEFT HAND OR RIGHT HAND



## Bi-fold Doors and Enclosures

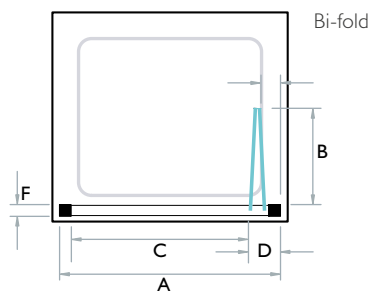

Size Options	Product Code	Adjustment mm		Dimension mm				
		Recess Door Only	Corner Door + 1 side	B	C	D	E	F
		A	A					
760 Bi-fold	3BF76S	705-745	732-752	300	545	107-127	56-76	45
800 Bi-fold	3BF80S	745-785	772-792	320	585	107-127	56-76	45
900 Bi-fold	3BF90S	845-885	872-892	370	685	107-127	56-76	45

Door Height - 1850mm – excluding tray

ALL BI-FOLDS CAN BE FITTED TO OPEN EITHER LEFT HAND OR RIGHT HAND

## Enclosure Panels

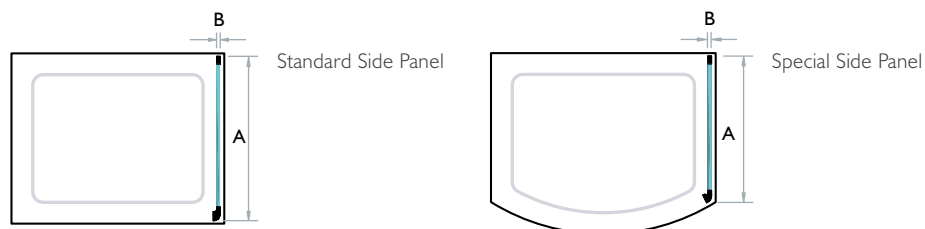

Size Options	Product Code	Adjustment mm	Dimension mm
		A	B
700 Standard Side Panel	3SP70S	672-687	17
760 Standard Side Panel	3SP76S	732-747	17
800 Standard Side Panel	3SP80S	772-787	17
900 Standard Side Panel	3SP90S	872-887	17
700 Special Side Panel for use with 1200 Bowed Sliding Doors	3SPB70S	685-700	17
800 Special Side Panel for use with 800 & 900 Bowed Pivot Doors	3SPB80S	785-800	17

Panel Height – 1850mm – excluding tray

PANELS ARE UNHANDLED & CAN BE FITTED TO EITHER SIDE OF THE DOOR

for shower enclosures you can trust...

# infinite

by KUDOS

The stunning KUDOS **infinite** range offers a modern, minimalist look with many design features that improve, enhance and enrich the range, making it one of the most technically advanced showering enclosure systems available today.

A choice of sliding, hinged or centre-folding doors and enclosures in sizes ranging from 760 up to 1700. All KUDOS **infinite** doors have the versatility to fit in a recess or with the addition of one or two KUDOS side panels, will create two or three sided enclosures. This gives a range of options to suit even the most adventurous interior designer.

## Key features are:

- + Crystal clear, glass to glass seals
- + Chrome effect wall sections
- + Chrome plated, cast metal corner joints
- + Unique three dimensional adjustment system
- + Concealed fixings
- + Suitable for use with power showers†
- + 6-8mm toughened safety glass with Lifeshield™
- + Lifetime Guarantee\*



\*Guarantee applies to material and manufacturing defects only. See website for full Terms and Conditions. †Assuming shower head is positioned appropriately for normal shower use.





# infinite

## Centre-folding Doors and Enclosures

Whether a small or large showering area, the **infinite** Centre-folding Doors and Enclosures offer luxury without compromise. Practical space saving, spacious accessibility and style are all built in as standard.

Concealed, adjustable magnets enable the user to set the strength of the door closure to their personal preference. Whether recessed, corner or three-sided, the **infinite** Centre-folding range brings a new dimension to showering luxury.

- + 8mm toughened safety glass with Lifeshield™ protection
- + Unique three dimensional adjustment for out-of-true walls
- + Chrome plated cast metal hinges
- + Generous 1900mm door height
- + Left or Right hand opening

Enclosure Size Options	Product Code	Adjustment mm			Access width mm
		Recess	Corner	Peninsula	
760	4BF76	725-765	731-751	737	402
800	4BF80	765-805	771-791	777	442
900	4BF90	865-905	871-891	877	542
1000	4BF100	965-1005	971-991	977	592
1200	4BF120	1165-1205	1171-1191	1177	592



1000 Centre-fold with 800 Side Panel



High quality chromed cast fittings

For full technical details on this product, see pages 44-47. We recommend the use of a KUDOS **Kstone** shower tray with **infinite** Centre-folding Doors and Enclosures. Details and prices of corresponding tray sizes are available on pages 48-49.

Side Panel Size Options	Product Code	Adjustment mm
760 Standard Side Panel	4SP76	731-751
800 Standard Side Panel	4SP80	771-791
900 Standard Side Panel	4SP90	871-891
1000 Standard Side Panel	4SP100	971-991
1200 Standard Side Panel	4SP120	1171-1191



1500 Straight Sliding Door with 2 x 800 Side Panels

## infinite Straight Sliding Doors and Enclosures

8mm toughened safety glass combined with contemporary styling in-tune with the demands of modern lifestyles. Each capable of fitting into a recess or with one or two side panels, to create a corner or a three sided enclosure.

- + 8mm toughened safety glass with Lifeshield™ protection
- + Three-dimensional adjustment
- + Stainless Steel roller bearings for smooth opening action
- + Left or right hand opening
- + Generous 1900mm door height

Enclosure Size Options	Product Code	Adjustment mm			Access width mm
		Recess	Corner	Peninsula	
1200 Side Access	4SDS120	1165-1205	1171-1191	1177	401
1500 Side Access	4SDS150	1465-1505	1471-1491	1477	501
1700 Side Access	4SDS170	1665-1705	1671-1691	1677	501

For full technical details on this product, see pages 44-47. We recommend the use of a KUDOS **Kstone** shower tray with **infinite** Straight Sliding Doors and Enclosures. Details and prices of corresponding tray sizes are available on pages 48-49.

Side Panel Size Options	Product Code	Adjustment mm
760 Standard Side Panel	4SP76	731-751
800 Standard Side Panel	4SP80	771-791
900 Standard Side Panel	4SP90	871-891
1000 Standard Side Panel	4SP100	971-991
1200 Standard Side Panel	4SP120	1171-1191



# infinite

## Curved Enclosures with Sliding Doors

If you are looking for a stunning curved enclosure then look no further. Available as a corner unit in 2 sizes, 910 x 910 or 1000 x 1000 either 2 door centre access or single door side access or make a statement with the magnificent 1200 x 910 Peninsula Enclosure.

- + 6mm toughened safety glass with Lifeshield™ protection
- + Three-dimensional adjustment
- + Stainless Steel roller bearings for smooth opening action
- + Left or right hand opening
- + Generous 1900mm door height

Enclosure Size Options	Product Code	Adjustment mm	Access Width mm
910 Curved Enclosure - Centre Access	4CD91	880-897	558
910 Curved Enclosure - Side Access	4SCD91	880-897	475
1000 Curved Enclosure - Centre Access	4CD100	970-987	642
1000 Curved Enclosure - Side Access	4SCD100	970-987	566
1200 Peninsula Enclosure	4PEN129	1174	609



1000 Curved Enclosure with Side Access



1200 Peninsula Enclosure

For full technical details on this product, see pages 44-47. The unique shape of **infinite** Curved Corner Enclosures require a matching KUDOS **concept** shower tray. See pages 50-51 for more information.

Tray Options	Product Code
910 x 910	DC91W
1000 x 1000	DC100W
Peninsula	DPEN129W



| 1200 Offset Curved Enclosure with Side Access

## infinite Offset Curved Corner Enclosures with Sliding Doors

With all the same features as the standard **infinite** Curved Corner Enclosure, the KUDOS Offset Curved Corner Enclosure provides greater versatility by shortening the length of one side whilst increasing the length of the other.

This helps overcome space issues caused by door or window locations. Available as 1000 x 810 or 1200 x 910, the required wall space on the short side is only 655mm and 724mm respectively. Both available in a choice of single door side access or 2 door centre access.

- + 6mm toughened safety glass with Lifeshield™ protection
- + Three-dimensional adjustment
- + Stainless Steel roller bearings for smooth opening action
- + Left or right hand opening
- + Generous 1900mm door height

Enclosure Size Options	Product Code	Adjustment mm	Access Width mm
1000 Offset Curved Enclosure - Centre Access	4CDOS108	970-987 / 780-797	558
1000 Offset Curved Enclosure - Side Access	4SCDOS108	970-987 / 780-797	475
1200 Offset Curved Enclosure - Centre Access	4CDOS129	1170-1187 / 880-897	618
1200 Offset Curved Enclosure - Side Access	4SCDOS129	1170-1187 / 880-897	596

For full technical details on this product, see pages 44-47. The unique shape of **infinite** Offset Curved Corner Enclosures require a matching KUDOS **concept** shower tray. See pages 50-51 for more information.

Tray Options	Product Code
1000 x 810	DCOS108W
1200 x 910	DCOS129W



| 1200 Offset Curved Enclosure with Centre Access

# infinite

## Bowed Sliding Doors and Enclosures

Sheer indulgence is the best way to describe the **infinite** Bowed Sliding Door Enclosure. Choose from 1200, 1500 or 1700 width options, each of which tapers to 700mm at each end.

Never before has it been possible to create such a large enclosure in such a relatively small space. The 1700 version will fit in the same space as a standard bath and provide you with a showering area you could have only dreamed about.

All Bowed Sliding Doors can be fitted between two walls (recessed) or with either one or two special 700 side panels to create a corner or three-sided enclosure.

- + 6mm toughened safety glass with Lifeshield™ protection
- + Three-dimensional adjustment
- + Stainless Steel roller bearings for smooth opening action
- + Left or right hand opening
- + Generous 1900mm door height



| 1700 Bowed Sliding Door for Recess



| 1500 Bowed Sliding Door with 700 Special Side Panel

Enclosure Size Options	Product Code	Adjustment mm			Access Width mm
		Recess	Corner	Peninsula	
1200 Side Access	4BOWS120	1170-1205	1172-1189	1174	365
1500 Side Access	4BOWS150	1470-1505	1472-1489	1474	512
1700 Side Access	4BOWS170	1655-1690	1657-1674	1659	608

Side Panel Size Option	Product Code	Adjustment mm
700 Special Side Panel (for Bowed Doors only)	4SPB70	678-698

For full technical details on this product, see pages 44-47. The unique shape of **infinite** Bowed Sliding Doors require a matching KUDOS **concept** shower tray. See pages 50-51 for more information.

Tray Options	Product Code
1200 x 700	DBI20W
1500 x 700	DBI50W
1700 x 700	DBI70W





800 Hinged Door for Recess

## infinite Straight Hinged Doors and Enclosures

With five door and five panel options the permutations are infinite, offering either recessed, corner or three-sided showering areas. The Kevlar impregnated hinges are guaranteed to last a lifetime.

- + 8mm toughened safety glass with Lifeshield™ protection
- + Unique three dimensional adjustment for out-of-true walls
- + Kevlar impregnated hinge mechanism
- + Magnetic self-closing return
- + Chrome cast hinges and corner joints
- + Generous 1900mm door height

Enclosure Size Options	Product Code	Adjustment mm			Access Width mm
		Recess	Corner	Peninsula	
800	4HD80*	765-805	771-791	777	425
900	4HD90*	865-905	871-891	877	525
1000	4HD100*	965-1005	971-991	977	525
1200	4HD120*	1165-1205	1171-1191	1177	655
1500	4HD150*	1465-1505	1471-1491	1477	655

For full technical details on this product, see pages 44-47. We recommend the use of a KUDOS **Kstone** shower tray with **infinite** Straight Hinged Doors and Enclosures. Details and prices of corresponding tray sizes are available on pages 48-49.

Side Panel Size Options	Product Code	Adjustment mm
760 Standard Side Panel	4SP76	731-751
800 Standard Side Panel	4SP80	771-791
900 Standard Side Panel	4SP90	871-891
1000 Standard Side Panel	4SP100	971-991
1200 Standard Side Panel	4SP120	1171-1191

\*KUDOS Hinged Doors are handed - add L or R suffix to product code when ordering. All **infinite** Doors and panels can be extended in increments of 10mm with an extension post. See page 42 for enclosure panel details.



# infinite Enclosure Panels

Available in a range of sizes, **infinite** Side Panels can be used to create a corner unit or a stunning three sided enclosure. Please note that only the Special 700 Panel can be used in conjunction with the **infinite** Bowed Sliding Door.

- + 8mm & 6mm toughened safety glass with Lifeshield™ protection
- + Unique three dimensional adjustment for out-of-true walls
- + Chromed cast corner joints
- + Generous 1900mm door height

For full technical details on this product, see pages 44-47.



Side Panel Size Options	Product Code	Adjustment mm
700 Special Side Panel (for use with Bowed Sliding Doors only)	4SPB70	678-698
760 Standard Side Panel	4SP76	731-751
800 Standard Side Panel	4SP80	771-791
900 Standard Side Panel	4SP90	871-891
1000 Standard Side Panel	4SP100	971-991
1200 Standard Side Panel	4SP120	1171-1191

Wall Extension Profiles	Product Code
10mm Extension Profile Door / panel (Pack of 2)	4SOSS



| 1500 Sliding Door shown with 2 x 800 side panels to create 3 sided enclosure

# infinite

## Centre-folding Doors and Enclosures

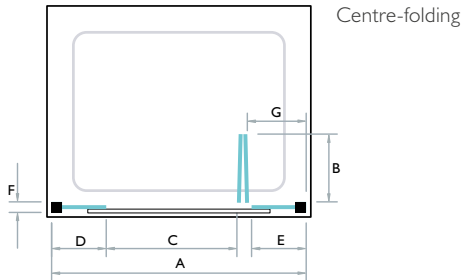

Size Options	Product Code	Adjustment mm			Dimension mm					
		Recess Door Only	Corner Door + 1 side	Peninsula	B	C	D	E	F	G
		A	A	A						
760	4BF76	725-765	731-751	737	195	402	137-157	137-157	42	135-155
800	4BF80	765-805	771-791	777	215	442	137-157	137-157	42	135-155
900	4BF90	865-905	871-891	877	265	542	137-157	137-157	42	135-155
1000	4BF100	965-1005	971-991	977	290	592	162-182	162-182	42	160-180
1200	4BF120	1165-1205	1171-1191	1177	290	592	262-282	262-282	42	260-280

Door Height - 1900mm – excluding tray

CENTRE-FOLDING DOORS CAN BE FITTED TO OPEN EITHER LEFT HAND OR RIGHT HAND

## Straight Sliding Doors and Enclosures

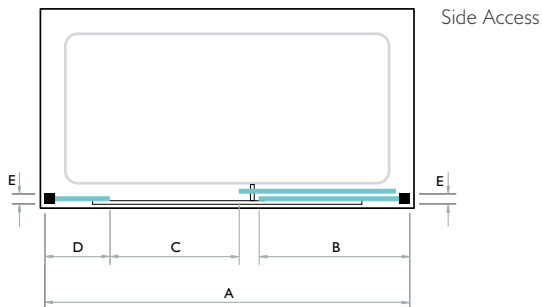

Size Options	Product Code	Adjustment mm			Dimension mm			
		Recess Door Only	Corner Door + 1 side	Peninsula	B	C	D	E
		A	A	A				
1200 Side Access	4SDS120	1165-1205	1171-1191	1177	493-513	401	163-183	42
1500 Side Access	4SDS150	1465-1505	1471-1491	1477	593-613	501	263-283	42
1700 Side Access	4SDS170	1665-1705	1671-1691	1677	693-713	501	363-383	42

Door Height - 1900mm – excluding tray

SIDE ACCESS DOOR CAN BE FITTED TO OPEN EITHER LEFT HAND OR RIGHT HAND

## Curved Enclosures with Sliding Doors

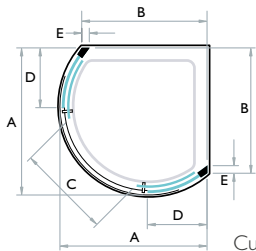

Curved Centre Access

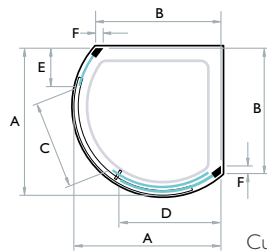

Curved Side Access

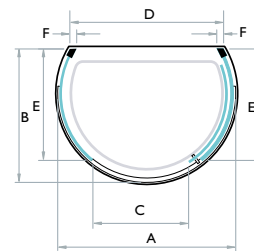

Peninsula

Size Options	Product Code	Adjustment mm			Dimension mm		
		A	B	C	D	E	F
910 Curved Enclosure - Centre Access	4CD91	880-897	801-818	558	376-393	49	-
910 Curved Enclosure - Side Access	4SCD91	880-897	801-818	475	585-602	262-279	49
1000 Curved Enclosure - Centre Access	4CD100	970-987	828-845	642	413-430	59	-
1000 Curved Enclosure - Side Access	4SCD100	970-987	828-845	566	675-692	247-264	59
1200 Peninsula Enclosure	4PENS129	1174	880-897	609	1017	736-753	49

Enclosure Height - 1900mm – excluding tray

CURVED SLIDING DOORS CAN BE FITTED TO OPEN EITHER LEFT HAND OR RIGHT HAND

## Offset Curved Corner Enclosures with Sliding Doors

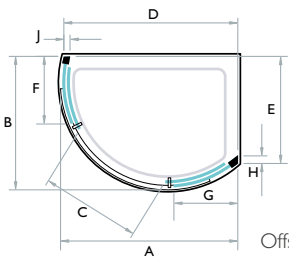

Offset Centre Access

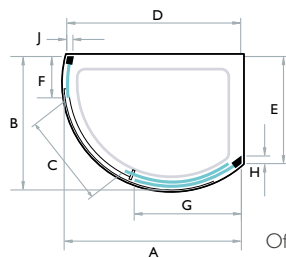

Offset Side Access

Size Options	Product Code	Adjustment mm			Dimension mm					
		A	B	C	D	E	F	G	H	J
1000 Offset Curved Enclosure - Centre Access	4CDOS108	970-987	780-797	558	937-954	638-655	380-397	360-377	59	44
1000 Offset Curved Enclosure - Side Access	4SCDOS108	970-987	780-797	475	937-954	638-655	268-285	579-596	59	44
1200 Offset Curved Enclosure - Centre Access	4CDOS129	1170-1187	880-897	618	1148-1165	707-724	465-482	443-460	59	43
1200 Offset Curved Enclosure - Side Access	4SCDOS129	1170-1187	880-897	596	1148-1165	707-724	268-285	698-715	59	43

Enclosure Height - 1900mm – excluding tray

OFFSET CURVED SLIDING DOORS CAN BE FITTED TO OPEN EITHER LEFT HAND OR RIGHT HAND

## Bowed Sliding Doors and Enclosures

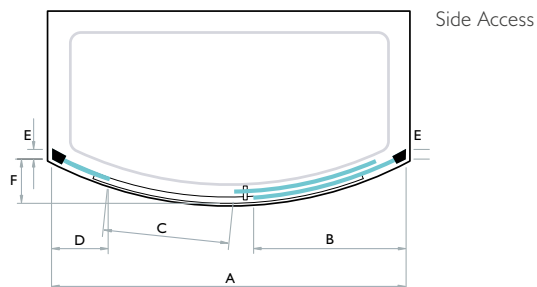

Size Options	Product Code	Adjustment mm			Dimension mm				
		Recess Door Only	Corner Door + 1 side	Peninsula	B	C	D	E	F
		A	A	A					
1200 Side Access	4BOWS120	1170-1205	1172-1189	1174	452-469	365	248-265	49	145
1500 Side Access	4BOWS150	1470-1505	1472-1489	1474	595-612	512	254-271	49	183
1700 Side Access	4BOWS170	1655-1690	1657-1674	1659	693-710	608	253-270	49	205

Door Height - 1900mm – excluding tray

DOORS CAN BE FITTED TO OPEN EITHER LEFT HAND OR RIGHT HAND

## Straight Hinged Doors and Enclosures

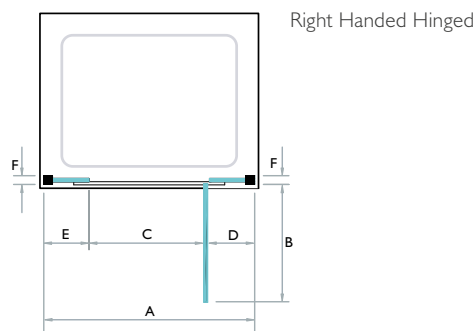
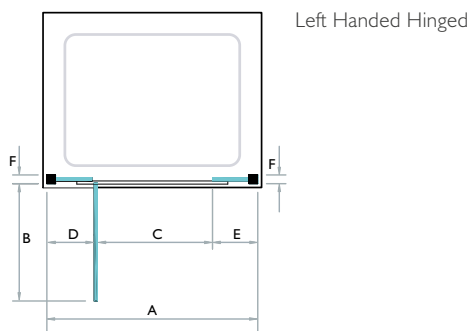

Size Options	Product Code	Adjustment mm			Dimension mm				
		Recess Door Only	Corner Door + 1 side	Peninsula	B	C	D	E	F
		A	A	A					
800	4HD80*	765-805	771-791	777	437	425	170-190	157-177	42
900	4HD90*	865-905	871-891	877	537	525	170-190	157-177	42
1000	4HD100*	965-1005	971-991	977	537	525	220-240	207-227	42
1200	4HD120*	1165-1205	1171-1191	1177	667	655	255-275	242-262	42
1500	4HD150*	1465-1505	1471-1491	1477	667	655	405-425	392-412	42

Door Height - 1900mm – excluding tray

ALL HINGED DOORS ARE HANDED - PLEASE SPECIFY LEFT OR RIGHT HAND HINGED (See Illustrations)

## Enclosure Panels

Product Size	Product Code	Adjustment mm	Dimension mm
		A	B
700 Special Side Panel (for use with Bowed Sliding Doors only)	4SPB70	678-698	42
760 Standard Side Panel	4SP76	731-751	42
800 Standard Side Panel	4SP80	771-791	42
900 Standard Side Panel	4SP90	871-891	42
1000 Standard Side Panel	4SP100	971-991	42
1200 Standard Side Panel	4SP120	1171-1191	42

Panel Height - 1900mm – excluding tray

PANELS ARE UNHANDED AND CAN BE FITTED TO EITHER SIDE OF THE DOOR

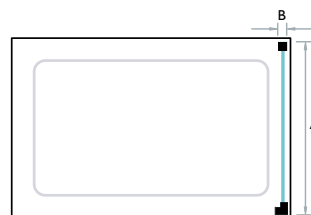

Standard Side Panel

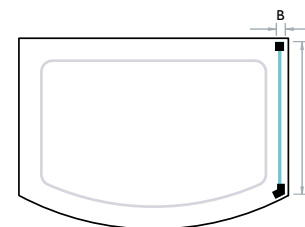

Special Side Panel

for shower trays you can trust...

# Kstone

by KUDOS

The shower tray is the most important element of any shower enclosure and the choice you make is critical to the long term performance of your shower installation. Getting it wrong could leave you facing potentially expensive and disruptive remedial work, so make the right decision by choosing **Kstone**.

Manufactured in our own UK factories and covered by a lifetime guarantee, **Kstone** trays are made from the highest quality materials, including an acrylic capped skin which provides a superb high gloss finish that is durable as well as being resistant to impact damage and staining whilst the structural resin bonded stone filler provides incredible stability.

#### Key features are:

- + High-gloss acrylic capped ABS skin for durability and resistance to impact damage
- + Structured resin bonded stone filler for increased stability
- + 45mm high
- + Suitable for 90mm waste (supplied separately)
- + Covered by the KUDOS Lifetime Guarantee\*



We recommend Flexi-Seal in the installation of **Kstone** trays

#### Flexi-Seal - Flexible Waterproof Seal

Flexi-Seal uses a combination of a durable flexible rubber with a waterproof butyl based adhesive to give maximum protection between the application surface and tiles or panels.

Since the rubber is flexible, it will maintain a watertight seal whilst allowing for a certain amount of movement that is inevitable, particularly with new builds.



\* Guarantee applies to material and manufacturing defects only. See website for full Terms, Conditions and fitting instructions.

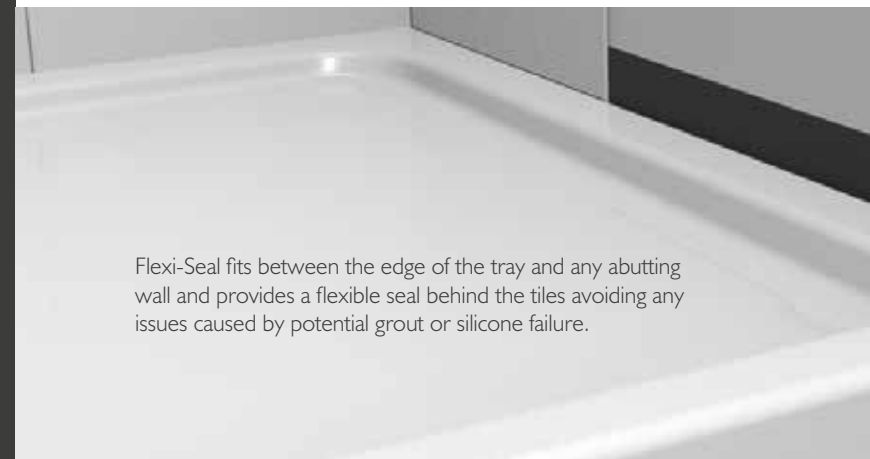

Flexi-Seal fits between the edge of the tray and any abutting wall and provides a flexible seal behind the tiles avoiding any issues caused by potential grout or silicone failure.





## ◀ Square/ Rectangular Options

Waste	Length mm	Width mm	Code
	760	760	KS76
	800	800	KS80
	900	900	KS90
	1000	1000	KS100
	900	700	KS9070
	900	760	KS9076
	900	800	KS9080
	1000	700	KS10070
	1000	760	KS10076
	1000	800	KS10080
	1000	900	KS10090
	1100	700	KS11070
	1100	760	KS11076
	1100	800	KS11080
	1100	900	KS11090
	1200	700	KS12070
	1200	760	KS12076
	1200	800	KS12080
	1200	900	KS12090
	1400	700	KS14070
	1400	800	KS14080
	1400	900	KS14090
	1500	700	KS15070
	1500	800	KS15080
	1500	900	KS15090
	1600	700	KS16070
	1600	800	KS16080
	1600	900	KS16090
	1700	700	KS17070
	1700	800	KS17080
	1700	900	KS17090

## ▼ Accessories

Product	Size	Code
Hi-flow Waste	90mm	DWA90S
Flexi-Seal	2 metres	KFS2
Flexi-Seal	3 metres	KFS3
Flexi-Seal	4 metres	KFS4
Leg Set & Plinth	Trays up to 1000	KSPK100
Leg Set & Plinth	Trays up to 1200	KSPK120
Leg Set & Plinth	Trays up to 1700	KSPK170
Leg Set & Plinth	All Quad Trays	KSPQ

## ▼ Quad Options

Waste	Length mm	Width mm	Code
	800	800	KSQ80
	900	900	KSQ90
	1000	1000	KSQ100



## ▼ Offset Quad Options

Waste	Length mm	Width mm	Code
	900	760	KSQ9076
	900	800	KSQ9080
	1000	800	KSQ10080
	1000	900	KSQ10090
	1200	800	KSQ12080
	1200	900	KSQ12090

Offset Quad trays are handed see below. When ordering please suffix code with LH or RH.



## ▼ Tray Waste Location



Corner Location Square & Rectangular	A	B
900 x 900	140mm	140mm
1000 x 900	155mm	155mm
1100 x 900	155mm	155mm
All other sizes	150mm	150mm

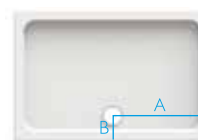

Centre Location Rectangular	A	B
All sizes	Centre of tray	160mm

e.g. 1400 x 800 A = 700mm B = 160mm



Corner Location Quad & Offset Quad	A	B
800 x 800	150mm	150mm
1000 x 1000	135mm	135mm
900 x 760	145mm	145mm
900 x 800	145mm	145mm

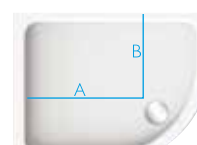

Centre Location Quad & Offset Quad	A	B
900 x 900	645mm	645mm
1000 x 800	732mm	532mm
1000 x 900	732mm	632mm
1200 x 800	925mm	525mm
1200 x 900	925mm	625mm

for shower trays you can trust...

# concept

by KUDOS

Created specially for use with uniquely shaped KUDOS enclosures **concept** shower trays feature a stable structural resin bonded stone backing and a durable acrylic-capped ABS skin that provides a superior high-gloss finish with a high resistance to damage and staining.

## Key features are:

- + 55mm high
- + Durable acrylic capped ABS skin
- + Superior high gloss finish
- + High resistance to impact damage
- + Stable resin-bonded stone backing
- + Requires 90mm waste
- + Lifetime Guarantee\*



We recommend Flexi-Seal in the installation of concept trays

## Flexi-Seal - Flexible Waterproof Seal

Flexi-Seal uses a combination of a durable flexible rubber with a waterproof butyl based adhesive to give maximum protection between the application surface and tiles or panels.

Since the rubber is flexible, it will maintain a watertight seal whilst allowing for a certain amount of movement that is inevitable, particularly with new builds.



\* Guarantee applies to material and manufacturing defects only. See website for full Terms, Conditions and fitting instructions.



## The KUDOS Plinth makes fitting a **concept** shower tray easier and faster than ever.

The unique design consists of a dedicated steel frame on adjustable feet for easy and precise levelling. It also features a quality baseboard for a solid foundation. It's perfectly simple and straightforward to use and allows the tray to be elevated from 110mm to 130mm, giving easy access to plumbing. To enable you to achieve the perfect finish in a fraction of the time. KUDOS easy fit plinths for curved or bowed trays are supplied with a moulded panel for a professional and stylish finish.

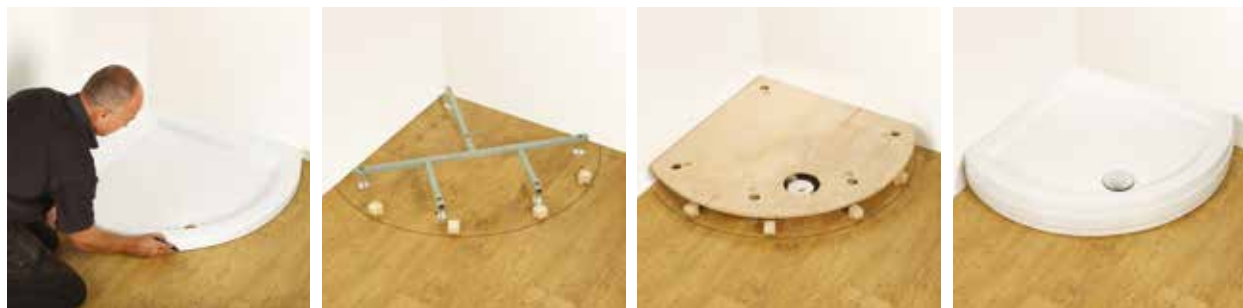

1. Use shower base as template
2. Adjustable steel frame for levelling and easy plumbing
3. Easy fit baseboard for total support, providing easy access to waste connection
4. Plinths are available to suit all **concept** trays.

Moulded fascia panels fit under the tray when plinth height set at 110mm, a surface mounted, flexible, flat panel is available where it is necessary to raise the plinth higher than 110mm.

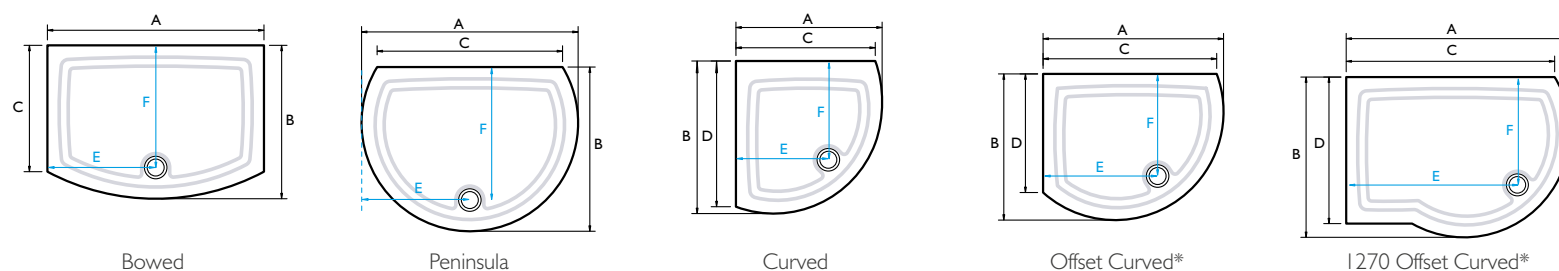

Concept Trays	Size Options	Product Code	Dimensions				Waste Position		Plinth Code
			A	B	C	D	E	F	
Curved	810 x 810	DC81W	810	810	772	772	512	512	PLP81C†
	910 x 910	DC91W	910	910	824	824	612	612	PLP91C†
	1000 x 1000	DC100W	1000	1000	847	847	702	702	PLPC100W†
Peninsula	1200 x 910	DPEN129W	1200	910	1027	-	600	737	PLPPEN129W†
Bowed	800 x 800	DB80W	800	905	800	-	400	735	PLP80BF†
	900 x 800	DB90W	900	920	800	-	450	746	PLP90BF†
	1200 x 700	DB120W	1200	850	700	-	600	677	PLP127BF†
	1500 x 700	DB150W	1500	888	700	-	750	714	PLPB150W†
	1700 x 700	DB170W	1685	910	700	-	843	737	PLPB170W†
Offset Curved LH	1000 x 810	DCOS108LW	1000	810	962	657	635	566	PLP1080SL†
Offset Curved RH	1000 x 810	DCOS108RW	1000	810	962	657	635	566	PLP1080SR†
Offset Curved LH	1200 x 910	DCOS129LW	1200	910	1175	727	768	655	PLPCOS129LW†
Offset Curved RH	1200 x 910	DCOS129RW	1200	910	1175	727	768	655	PLPCOS129RW†
Offset Curved LH	1270 x 910	DCOSLW	1270	910	1185	830	972	612	PLP910SLW†
Offset Curved RH	1270 x 910	DCOSRW	1270	910	1185	830	972	612	PLP910SRW†

\*Available in Left or Right handed options - left hand version shown. 94mm waste hole dimension to suit KUDOS 90mm high flow waste with metal chrome domed top (supplied separately). †Plinths for Curved and Bowed trays are supplied with moulded fascia panel/s. Flow rate 42 litres/min with a constant 15mm head of water. Tested in accordance with BS EN274-2:2002. \*Guarantee applies to material and manufacturing defects only. See website for full Terms and Conditions.

for wet room systems you can trust...

# aqua4ma

by KUDOS

There is no doubt that a fully tiled wet-floor extending into the shower area creates a stunning look, but appearances can be deceptive and its what's lying beneath the surface that counts.

With **aqua4ma** by KUDOS you can create the perfect wet-room with the comfort of knowing that the elements you cannot see, but need to rely on, have been designed by one to the UK's leading manufacturers of high quality showering products with the added comfort of a lifetime guarantee against material or manufacturing defects.

Choose between the versatile **aqua4ma central**, suitable for both tiled and vinyl floor covering, or **aqua4ma linear** with its stylish tiled drain cover.

Both systems utilize the patented **aqua4ma** in-floor galvanized steel tray and a pre-shaped extruded uPVC shower deck which is waterproof and safe to walk on even before tiling and can be fitted to both wooden and solid floors.

Additional uPVC floor and wall panels can be added to create a complete wet-floor or total wet-room solution. Joints are solvent welded together to form a solid structure which is guaranteed waterproof for life\*.

Floor and wall panels can be screwed directly to wooden floors or bonded to solid floors with a cement based flexible tile adhesive. The uPVC panels self seal around screws so no further treatment is required and the system is ready to tile within minutes of fitting. Longevity is ensured as unlike other systems the robust nature of **aqua4ma** panels allow for the removal and replacement of tiles without compromising the waterproof integrity of the system.



\*Guarantee applies to material and manufacturing defects only. See website for full Terms and Conditions.



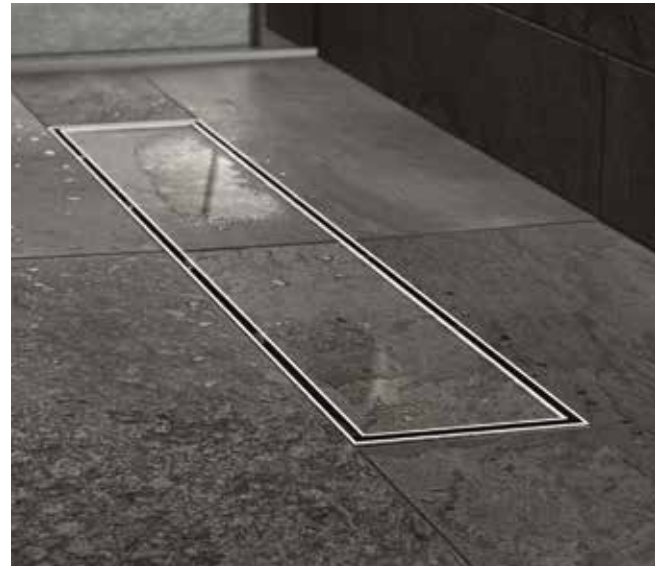

# aqua4ma linear

by KUDOS

As a home-owner you will appreciate the new **aqua4ma linear** Shower Deck for its high performance as well as its modern, sleek and stylish appearance.

As an installer you will not only appreciate the versatility, ease and speed of fitting the new **aqua4ma linear** Shower Deck, you will also enjoy the comfort of knowing that you are providing your customers with a product guaranteed for life\* and backed by a trusted British manufacturer.

## Key features are:

- + Ultra-low level 19mm shower deck
- + Fits to existing finished floor or to false floor created at joist level
- + Deck size: 1185mm x 900mm, easily extended
- + Simple and quick to install with no drying times
- + Installation allows for avoidance of joist location
- + Suitable for both wooden and solid floors
- + Waterproof and safe to walk on even before tiling
- + Stylish tiled drain insert
- + Easy to tile with no angled cuts required
- + Suitable for large and small tile formats
- + Discharge rate up to 37 litres per minute

\*Guarantee applies to material and manufacturing defects only.  
See website for full Terms and Conditions.

## The aqua4ma linear kit





Stainless Steel Tiling Tray

Inner Cup

Stainless Steel Inner Frame

Threaded Connector

Blanking Plate

Skirting Panels

Linear Shower Deck

Threaded Connector

Steel Tray

Waste Body

# aqua4ma linear

...as versatile as you need



aqua4ma linear Shower Deck mounted on top of existing floor level.

19mm aqua4ma Panels can then be used to extend the waterproof area to the same height of the shower deck.

Standard: 19mm above existing floor level

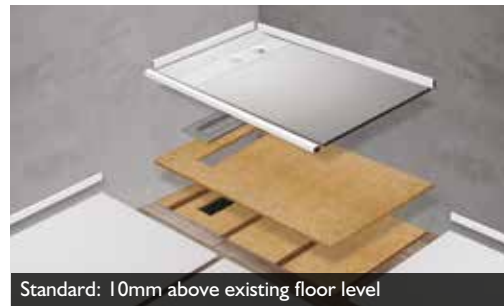

Flooring removed to size of aqua4ma Shower Deck, create a false floor at joist level, add plywood panel to lift shower deck 10mm above existing floor level to allow joining to aqua4ma Floor Panels. Then use aqua4ma 10mm Panels to waterproof all or part of the floor to the same height as the shower deck.

Standard: 10mm above existing floor level



Flooring removed to size of shower deck and false floor created at joist level. aqua4ma linear Shower Deck fitted.

Ultra-Low: 19mm above joist level



(Additional waterproof floor area at same level) Flooring removed to desired area and false floor created at joist level.

aqua4ma linear Shower Deck and 19mm floor panels fitted within the removed floor area.

Ultra-Low: 19mm above joist level

## Installing over joists

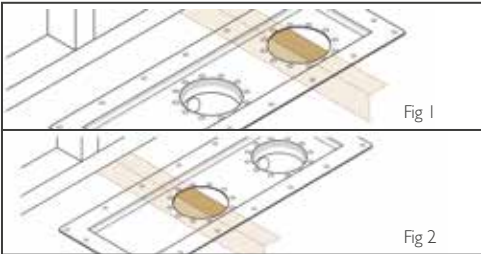
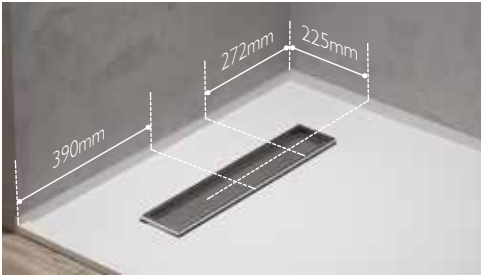

aqua4ma linear has two waste hole positions (Fig 1 & 2). If joists run along the length of the deck, you simply choose the position that will avoid them.

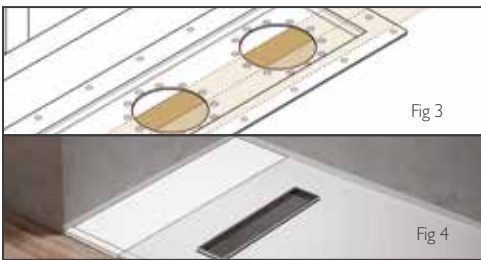

Should joists run across the deck (Fig 3) and obstruct the waste location, a wedge shaped extension panel is available (Fig 4). This 250mm trim-to-fit panel solvent welds to the base so it can be moved away from the obstructing joist whilst maintaining the fall to ensure efficient drainage.

## Width Extension Panels

The aqua4ma linear Shower Deck comes in a standard size of 1185mm x 900mm. This can be extended with the addition of the 300mm width extension pack.

Two sections of aqua4ma panelling each 150mm wide are shaped to match the falls of the shower deck and can be trimmed to suit the size required.



## Installing aqua4ma linear

aqua4ma's incredible versatility ensures you can create a wet room to suit your needs. How you install the aqua4ma Skirting, Floor and Wall Panels is only limited by the type of installation you want to make. The aqua4ma linear system can be installed on its own to provide a low-level shower deck or in conjunction with aqua4ma Floor / Wall Panels to create a larger, totally watertight area.

### Wet Area



#### Shower Deck Kit & Skirting installation

This installation incorporates the aqua4ma linear Shower Deck Kit plus Skirting to the showering area only. Remaining floor area must be built up to the same level as aqua4ma Base.

### Wet Floor



#### Floor & Skirting installation

Entire floor is covered using the appropriate aqua4ma Panels. The walls are fitted with aqua4ma Skirting Panels.

### Wet Room



#### Shower Area installation

Entire floor plus walls within the shower area are covered using the appropriate aqua4ma Panels. The remainder of the walls are fitted with aqua4ma Skirting Panels.



## aqua4ma linear

### Carry-Out Pack

aqua4ma linear is not only simple and straightforward to install, we have also made the purchasing process easier with our handy carry out packs. Our most popular sizes are now available in pre-packed boxes that will provide you with everything needed to install a 3 or 4m<sup>2</sup> wet room area right away.

#### Each complete pack contains:

- + 1 185mm x 900mm Linear Shower Deck
- + aqua4ma Panels either 19mm (standard level) or 10mm (low level)
- + Skirting panels
- + Length extension to help avoid joists
- + Waste kit
- + Grabber and solvent weld
- + 1 185mm x 900mm x 10mm plywood panel (low level only)



4m<sup>2</sup> - Standard level



4m<sup>2</sup> - Low level

## aqua4ma linear

### Shower Deck Kit

inc. metal panel, waste, grabber and solvent weld

Description	Product Code
1 185 x 900 Linear Shower Deck Kit	WRLT12900

## aqua4ma

### Panel Packs

Description	Product Code
1200 x 800 x 10mm - pack of 2	WRAQ102
1200 x 800 x 10mm - pack of 3	WRAQ103
1200 x 800 x 13mm - pack of 2	WRAQ132
1200 x 800 x 13mm - pack of 3	WRAQ133
1200 x 800 x 15mm - pack of 2	WRAQ152
1200 x 800 x 15mm - pack of 3	WRAQ153
1200 x 800 x 19mm - pack of 2	WRAQ192
1200 x 800 x 19mm - pack of 3	WRAQ193

## aqua4ma

### Skirting

Description	Product Code
1200 x 150 x 10mm - Pack of 4	WRAQSK102
1200 x 150 x 15mm - Pack of 4	WRAQSK152

## aqua4ma linear

### Extension Panels

Description	Product Code
Width Extension Panels - pack of 2	WRLT150EXT
Length Extension Panel	WRLT250EXT

## aqua4ma

### Fixings

Description	Product Code
Solvent Weld - 300ml tube	WRSW

## aqua4ma linear

### Carry Out Packs

Description	Product Code
3m <sup>2</sup> - Standard level	WRSLK319
4m <sup>2</sup> - Standard level	WRSLK419
3m <sup>2</sup> - Low level	WRFLK310
4m <sup>2</sup> - Low level	WRFLK410

# aqua4ma central

by KUDOS

With a choice of deck sizes and suitability for both tile and vinyl flooring the **aqua4ma central** system is versatile and suitable for virtually any situation. The 5 standard deck sizes can be trimmed to suit exact requirements and tiling is made easy with the tiling guide printed on the shower deck panel.

## Key features are:

- + Quick and easy to install
- + Suitable for use on timber or solid wall/floor areas
- + Minimal joinery required
- + No need to reduce height of floor joists or cut floorboards flush with adjoining wall
- + Suitable for standard 18mm and 22mm flooring
- + No taping or wet trades required so no drying time to factor in
- + Suitable for tile or vinyl flooring options
- + Suitable for use with underfloor heating
- + Easy replacement of damaged tiles without compromising the integrity of the system
- + Fixing screws can be simply driven through the panels (no washers or taping required)

\*Guarantee applies to material and manufacturing defects only.  
See website for full Terms and Conditions.





## aqua4ma central shower tray pack

The aqua4ma central Shower Tray Pack includes all the elements needed to provide a strong, safe, reliable and watertight showering base. **Each pack consists of:**

### Shower Base

The uPVC Pre-formed base allows water drainage down all 4 sides to the integrated waste. No pre-treatment is required as all bases are manufactured with a rough textured finish to give an excellent key for tile and vinyl adhesives.

### Galvanised Metal Tray

Strong galvanised tray to accept shower base and is screw fixed to joists and floorboards.

### Waste Unit

Tiled waste option and vinyl waste option available. Specifically designed by McAlpine, the waste unit fixes to the underside of the metal tray and can be rotated through 15° increments to assist in plumbing work. The top access trap has a removable dip tube for easy cleaning. Standard 50mm water seal designed to take 50mm/2" solvent weld waste pipe (not supplied). Flow rates based on 15mm head of water:

**Tiled option** - 37 litres/min

**Vinyl option** - 33 litres/min

### Grabber adhesive

Used to bond shower base to metal tray during installation.

### Packing pieces

4mm thick packing strips for fixing to joists when installing on 22mm thick floorboards.

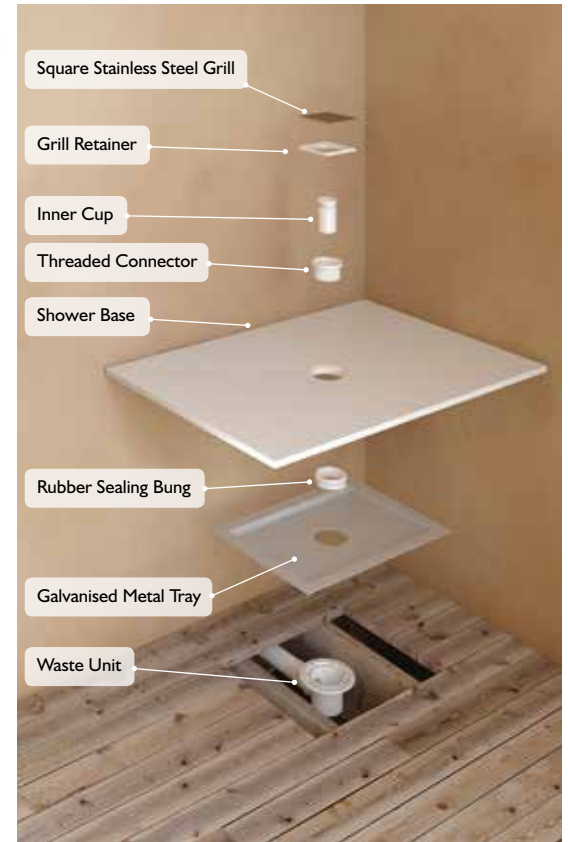

## Tray pack size options

aqua4ma is now more flexible and versatile than ever. aqua4ma central Tray Packs are available in 5 standard sizes, the base being trimmable for maximum versatility.

Bases can be cut to various shapes and sizes by trimming one, two, three or all four sides of the base sides up to the non-trimmable area, giving you the opportunity to create an infinite number of tray sizes to suit almost any bathroom requirement.

■ Trimmable area    □ Metal Tray area

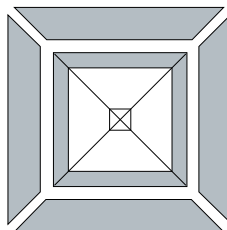

### 1300 x 1300mm:

Made up of 900 x 900 base plus 4 x 200 mitred extension pieces.  
Metal tray 700 x 700mm  
15mm base outer edge

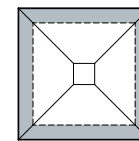

### 900 x 900mm

Metal tray 700 x 700mm  
10mm base outer edge

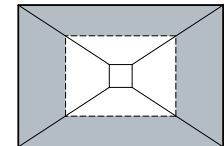

### 1500 x 900mm

Metal tray 800 x 510mm  
15mm base outer edge

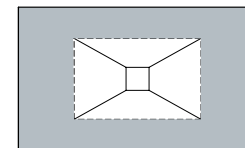

### 1300 x 900mm

Metal tray 700 x 510mm  
15mm base outer edge

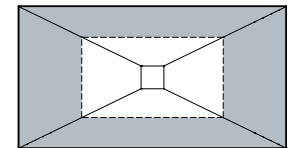

### 1700 x 900mm

Metal tray 900 x 510mm  
15mm base outer edge

## Key installation stages



1. Place shower base in required position against wall/s and mark position of centre waste hole onto flooring. Remove base and position metal tray ensuring waste hole is centred over marked position. Mark corners of tray onto flooring. Measure and draw lines inside of marked corners, this is the area of flooring to be removed.



2. Using circular saw, saw depth to suit floor thickness and remove the area of floorboards. Connect waste body using 50mm/2" solvent weld waste pipe (not supplied), ensuring waste body is positioned to centre of the cut-out. Screw fix 4" x 2" (100 x 50mm) timbers (not supplied) to underside of flooring to strengthen the edges of the cut-out.



3. Mark centre lines of exposed joists onto flooring. Insert metal tray into cut-out and transfer drawn lines onto tray. Drill and countersink two holes per joist through metal tray to suit csk-head wood screws (not supplied). Screw metal tray into position.



4. Apply beads of KUDOS Grabber Adhesive to base of metal tray and the 4 outer flanges as shown. Carefully position shower base into position and stand on it to ensure it is fully bedded down onto tray and floor. Secure in place by using drywall screws (not supplied) around the perimeter at 150mm centres ensuring these avoid the metal tray underneath.



5. Using KUDOS Solvent Weld, apply a continuous bead to the edge of the shower base, as shown. Lay the first aqua4ma panel up to the edge of the base applying pressure to ensure the panel is fitted firmly against the base edge. Secure the panel in place using drywall screws at 150mm centres, then wipe clean surplus solvent weld. Joints should be staggered, as shown to help strengthen the overall assembly.



6. Apply a continuous bead of solvent weld to the edge of the shower base, as shown. Lay the first panel onto base and against the wall applying pressure to ensure the panel is fitted firmly against the base. Secure the panel in place using drywall screws at approx. 150mm centres into the stud-work, then wipe clean surplus solvent weld.

Panels can be fixed to solid walls, e.g. brickwork or blockwork, by applying a cement based flexible tile adhesive (NOT READY MIXED) to the back of the panels using a deep notched trowel.

Full installation instructions can be downloaded from our website at [www.kudosshowers.co.uk](http://www.kudosshowers.co.uk)

## Avoiding joists or pipes

Avoiding joists or pipes under the floorboards is easy with aqua4ma.

If the base position results in the waste being over a joist you can either trim the base then re-position against wall/s or offset the base away from the relevant wall and fill the gap using aqua4ma panel.



## aqua4ma panels



### aqua4ma Panels

aqua4ma Panels are available in three different thicknesses, 10mm, 13mm and 15mm, to suit the relevant Shower base. Each supplied either in 2 or 3 panel packs. The panels measure 1200 x 800mm (approx.) providing almost a square metre of coverage.

15mm panels are supplied with tongue and grooved edges to assist on installation. 10mm and 13mm panels are supplied square edged.

Please refer to the table below to calculate which panel thickness you require for floor.



### aqua4ma Skirting

Available in 10mm and 15mm thicknesses aqua4ma Skirting measures 1200 x 150mm and are supplied in packs of four.

aqua4ma Panels and Skirting are both easily trimmable and can be fitted to both floor and walls by either screw fix method for timber floors and wall studwork or by applying cement based flexible tile adhesive to reverse of panels for solid floors and walls.

No pre-treatment is required as all panels are manufactured with a rough textured finish to give an excellent key for tile and vinyl adhesives.



### aqua4ma Solvent Weld

aqua4ma Solvent Weld (sold separately) is supplied in 300ml tubes, suitable for 20 linear metres of joints or approximately four 1200 x 800 aqua4ma Panels and is applied using a standard 'silicone gun'.

This specially formulated solvent provides an incredibly strong and watertight joint to all uPVC panels and Shower base.

## Trimmable bases offer greater flexibility

### Shower base - Trimmable details

All shower bases feature printed guidelines. If necessary, trim to these guidelines (or in between guidelines and following diagonal lines) to ensure both waste symmetry and equal thickness around all 4 edges.

The bases can also be trimmed on one, two or three sides - any cut side(s) should be placed against a wall to ensure the outer uncut side(s) retaining the same edge thickness, face into the room.

Please refer to table shown to calculate the reduction in edge thickness dependent on amount trimmed on each side.

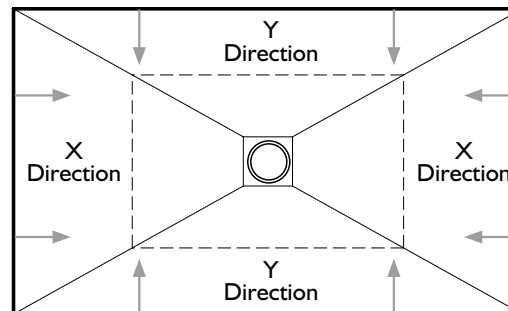

Shower Tray Size	Reduction in outer edge thickness for every 10mm trim	
	X	Y
900 x 900	0.25mm	0.25mm
1300 x 1300	0.25mm	0.25mm
1300 x 900	0.25mm	0.37mm
1500 x 900	0.20mm	0.37mm
1700 x 900	0.18mm	0.37mm

## Installing panels & skirting

To achieve a flush finish to existing wall surface, plasterboard/plaster must be removed then panels & skirting are fitted to studwork/solid wall flush to wall surface. Shower base must be positioned to studwork/solid wall so that panels and skirting can be solvent welded to top of this.

Plasterboard/plaster to be removed and skirting panels fitted ensuring these are flush with the wall surface.

Solvent weld all joints.

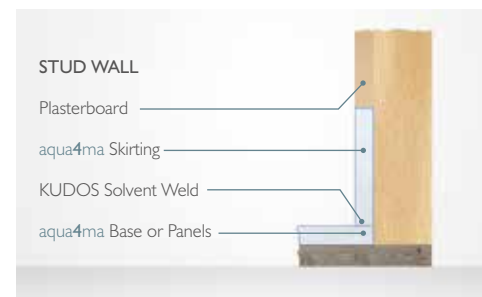
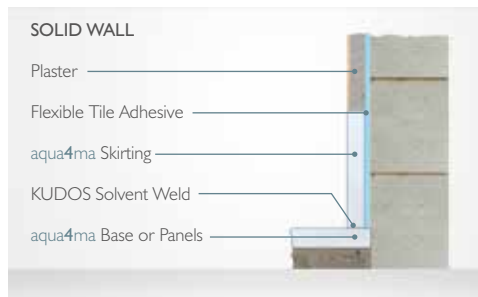

## Installing aqua4ma to meet your needs

aqua4ma's incredible versatility ensures you can create a wet room to suit your needs. How you install the aqua4ma Skirting, Floor / Wall Panels is only limited by the type of installation you want to make.



### Full Room Installation

Entire floor and all walls are covered with the appropriate aqua4ma Panels.

**Note:** Guarantee of water tightness applies only to where the aqua4ma product has been installed.



### Shower Room Installation

Entire floor plus walls within the shower area are covered using the appropriate aqua4ma Panels.

The remainder of the walls are fitted with aqua4ma Skirting Panels.



### Floor & Skirting Installation

Entire floor is covered using the appropriate aqua4ma Panels. The walls are fitted with aqua4ma Skirting Panels.



### Shower Tray Pack & Skirting Installation

This installation incorporates the aqua4ma central Shower Tray Pack plus Skirting to the showering area only.

Remaining floor area must be built up to the same level as aqua4ma Base.

## Tiling Shower bases

All aqua4ma central Bases have cutting and tiling guides printed on the surface. Tiles should be cut to follow the lines from the corner of the waste to the corner of the tray to ensure correct drainage.

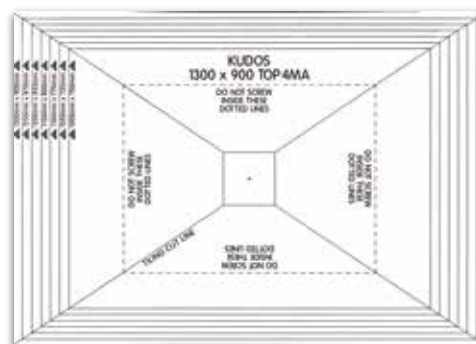



### aqua4ma central Shower Tray Packs - for tiled surfaces

Each pack consists of shower base, metal tray, grabber adhesive & tile waste unit.

Description	Product Code
900 x 900mm Pack	WR900
1300 x 1300mm Pack* includes extension pieces	WR1300
1300 x 900mm Pack	WR13900
1500 x 900mm Pack	WR15900
1700 x 900mm Pack	WR17900

### aqua4ma central Shower Tray Packs - for vinyl surfaces

Each pack consists of shower base, metal tray, grabber adhesive & vinyl waste unit.

Description	Product Code
900 x 900mm Pack	WR900V
1300 x 1300mm Pack* includes extension pieces	WR1300V
1300 x 900mm Pack	WR13900V
1500 x 900mm Pack	WR15900V
1700 x 900mm Pack	WR17900V

### aqua4ma Panel Packs

Description	Product Code
1200 x 800 x 10mm Pack of 2 panels	WRAQ102
1200 x 800 x 10mm Pack of 3 panels	WRAQ103
1200 x 800 x 13mm Pack of 2 panels	WRAQ132
1200 x 800 x 13mm Pack of 3 panels	WRAQ133
1200 x 800 x 15mm Pack of 2 panels	WRAQ152
1200 x 800 x 15mm Pack of 3 panels	WRAQ153

### aqua4ma Skirting Packs

Description	Product Code
1200 x 150 x 10mm Pack of 4 lengths	WRAQSK102
1200 x 150 x 15mm Pack of 4 lengths	WRAQSK152

### aqua4ma Fixings

Description	Product Code
Solvent Weld 300ml tube	WRSW

\*1300 x 1300mm packs include solvent weld.



Standard waste option  
for tiled floors



Vinyl waste option for  
vinyl floor coverings

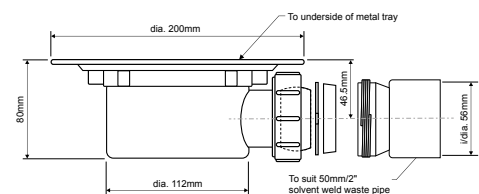

Small mosaic tiles will naturally follow the fall of the aqua4ma central deck without cutting

for bath screens you can trust...

# inspire

by KUDOS

Over-bath showering has long been considered a compromise of practicality over style and performance, but not anymore. The **inspire** collection by KUDOS makes no such compromise.

Hand-assembled using the best quality materials synonymous with the KUDOS brand, our stunning collection of bathscreens are designed to complement your bathroom space, whilst providing the benefit of a high performance showering facility.

Characterised by minimalist frameless design and innovative technologies, including unique click-to-lock hinges to hold your screen in place and our unique SmartSeal Technology, the **inspire** bathscreen collection delivers the ultimate in performance and is suitable to be used with high performance shower systems. All screens are treated with Lifeshield glass protection for easy cleaning.

Enjoy the invigorating pleasure of a shower whilst maintaining the opportunity to relax and indulge yourself in the comfort only a bath can provide.

## Key features are:

- + Lifetime Guarantee\*
- + Suitable for high performance showers†
- + Lifeshield Glass protection
- + All bath screens have 15mm adjustment unless indicated otherwise
- + All multi-panel bath screens feature unique click-to-lock hinges



\*Guarantee applies to material and manufacturing defects only.  
†Assuming shower head is positioned appropriately for normal shower use.  
See website for full Terms and Conditions.







indulge yourself in a relaxing bath or enjoy an invigorating shower.

Click-to-Lock hinges on Multi-Panel Screens

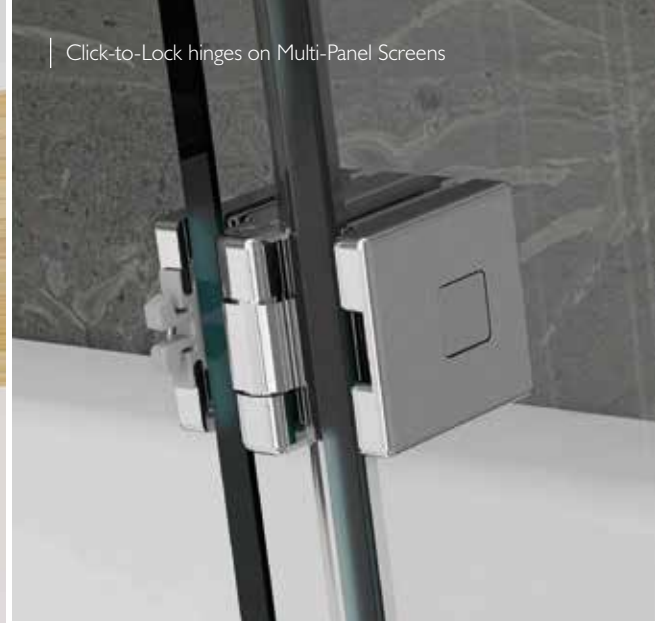

Frameless minimalist design

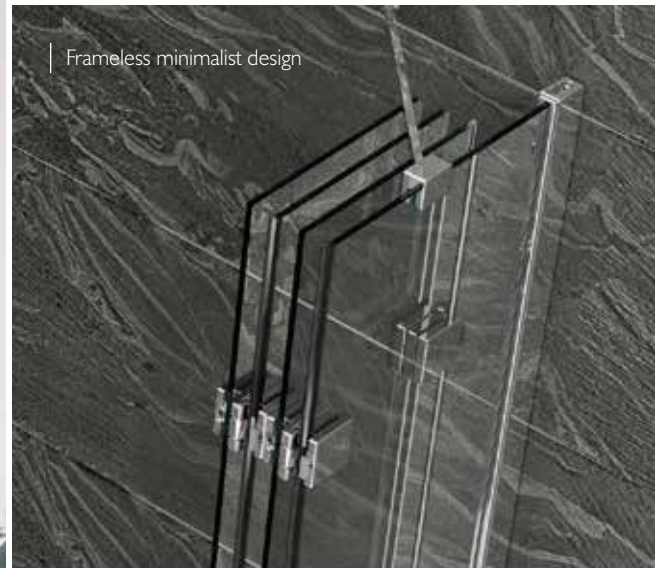

Suitable for high performance showers†



# inspire Single Panel Bathscreen

Available in 6mm and 8mm glass thickness, inspire Single Panel Bathscreens are larger than average, measuring 1500mm high and 850mm wide to provide a more generous showering area. For added comfort and convenience, inspire Single Panel Bathscreens are available with an integrated rail so you can keep your towel conveniently within reach.

SmartSeal Technology incorporates integrated mouldings and twin element profile and bath seals, delivering the ultimate shower protection.

Single Screens are reversible for left or right hand fixing.

Panel Options	Product Code
6mm Panel	3BASC6NHS
6mm Panel - inc. rail	3BASC6S
8mm Panel	3BASC8NHS
8mm Panel - inc. rail	3BASC8S

## Dimensions

Height 1500mm | Width 850mm

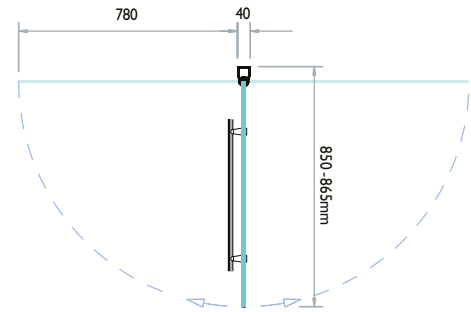

inspire

## Two Panel Out-Swing Bathscreen

Designed to provide an extended showering area of 950mm yet still provide access to the bath, the inspire Two Panel Out-Swing Bathscreen features a 305mm fixed panel which is permanently sealed to the bath providing absolute showering protection where you need it most. The larger 645mm panel opens out to allow access to shower controls and cleaning, whilst unique click-to-lock hinges hold the screen in position along the inner edge of the bath during use.

### In-Swing option: *(not illustrated)*

In this configuration the larger panel will swing from it's in-use position along the bath edge to over the bath. Before deciding on this option please ensure that the moving panel will not come into contact with, or prevent access to the shower controls.

Panel Options	Prod. Code Out-Swing	Prod. Code In-Swing
6mm Panel - LH	4BASC2PFOUHLHS	4BASC2PFINLHS
6mm Panel - RH	4BASC2PFOUHRHS	4BASC2PFINRHS
6mm Panel - inc. rail - LH	4BASC2PO6L	4BASC2PI6L
6mm Panel - inc. rail - RH	4BASC2PO6R	4BASC2PI6R
8mm Panel - LH	4BASC2PO8NHL	4BASC2PI8NHL
8mm Panel - RH	4BASC2PO8NHR	4BASC2PI8NHR
8mm Panel - inc. rail - LH	4BASC2PO8L	4BASC2PI8L
8mm Panel - inc. rail - RH	4BASC2PO8R	4BASC2PI8R

### Dimensions

Height 1500mm | Width 950mm

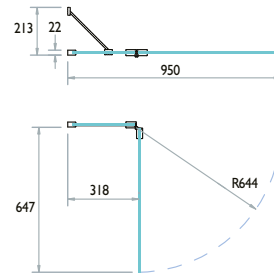

| Two Panel In-Fold right hand fixing

inspire

## Two Panel In-Fold Bathscreen

The inspire Two Panel In-Fold Bathscreen is available in both 6mm and 8mm glass thicknesses. Featuring a 500mm fixed panel that is permanently fixed to the bath and a smaller 375mm in folding panel which sits behind the fixed panel when not in use, allows easy access to the bath.

When in use the two panels provide a generous 875mm showering area. High quality, click-to-lock hinges secure the screen so it is positioned along the inner edge of the bath.

Panel Options	Product Code
6mm Panel - LH	4BASCDUOLHS
6mm Panel - RH	4BASCDUORHS
8mm Panel - LH	4BASCDUO8LH
8mm Panel - RH	4BASCDUO8RH

### Dimensions

Height 1500mm | Width 875mm

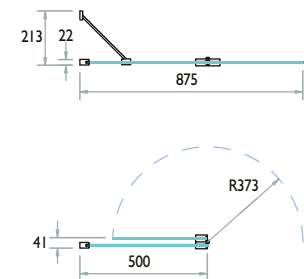



Three Panel In-Fold left hand fixing

## inspire Three Panel In-Fold Bathscreen

The stunning inspire Three Panel In-Fold Bathscreen is the ultimate in over bath showering protection.

The screen extends to 1250mm, yet folds to just 500mm when not in use providing the features of a relaxing bath as well as the benefit of an oversized shower area. Featuring unique click-to-lock hinges to ensure the panels remain in-line when in use.

Panel Options	Product Code
6mm Panel - LH	4BASCTRIPLPLHS
6mm Panel - RH	4BASCTRIPLPRHS

### Dimensions

Height 1500mm | Width 1250mm



## inspire Four Panel In-Fold Bathscreen

For those who require greater access to the bath without compromising on shower protection, the inspire Four Panel In-Fold Bathscreen is the solution.

Each of the three 215mm hinged panels sit comfortably behind the 305mm fixed panel providing virtually unimpeded access to the bath, yet when in use extends to 950mm for excellent showering protection.

Panel Options	Product Code
6mm Panel - LH	4BASCOMPLHS
6mm Panel - RH	4BASCOMPRHS

### Dimensions

Height 1500mm | Width 950mm



Four Panel In-Fold right hand fixing

# inspire

## L-Shaped Bathscreen

Designed to fit many of the square ended style baths that provide a large comfortable showering area. The inspire L-Shaped Bathscreen offers style, practicality, value and will enhance your L-shaped bath.

- + 5mm toughened glass
- + Reversible for left or right hand fitting
- + 20mm wallpost adjustment for out-of-true walls
- + Available with or without towel rail
- + Highly polished silver frame finish

Bathscreen Options	Product Code	
With rail	3BASKLWH	
No rail	3BASKL	

Dimensions  
Height 1500mm  
Width 810mm

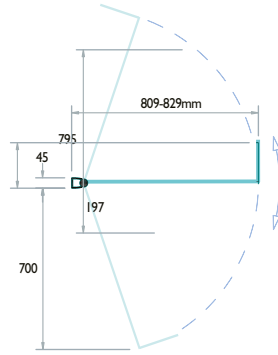

# inspire

## Over-Bath Shower Panel & Rail

The inspire Over-Bath Shower Panel with integrated shower rail, delivers the ultimate protection from water spillage. Its robust construction makes it ideal for use with the most powerful shower systems and its stylish & attractive design will complement any bathroom. Simple to install as new or as a retrofit, the fixed panel is permanently sealed to the bath edge and the wall, providing a watertight barrier.

- + 8mm toughened glass
- + 1500mm high x 350mm wide
- + Reversible for left or right hand fitting
- + 20mm wallpost adjustment for out-of-true walls
- + Bowed rail for greater space and comfort

Product adjustment allows (337-357mm). Suitable for all straight edged baths up to 2040mm (Cut rail to suit). 1200 x 800mm corner rail available (Cut 800mm side to suit bath width). Minimum required height above bath edge is 1600mm.

Bathscreen Options	Product Code	
Recess	5OBSPBRR	
Corner	5OBSPBCR	

Shower curtain and rings not included.

### Dimensions

Height 1556mm | Width 350mm

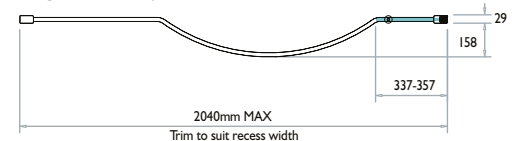

# bespoke

by KUDOS

Our extensive range of products cover a vast array of showering solutions with an unrivalled selection of overbath screens, enclosures and shower panels.

However, on occasions a standard sized product just will not suit the situation, in which case our bespoke service may be able to help. Many products within the KUDOS range can be tailor made to meet your requirements, whether it is a one-off special size shower door, a shaped panel to accommodate a sloping ceiling or a special design enclosure or bath screen for a housing development or hotel.

Whilst not all products can be made to measure we will apply our knowledge and expertise to try and provide you with a solution that meets your needs.



Contact our Bespoke  
Department for further details via  
[bespoke@kudosshowers.co.uk](mailto:bespoke@kudosshowers.co.uk)



# Thank you for your interest in KUDOS products

## PRODUCT AVAILABILITY

KUDOS products are available from specialist bathroom retailers and plumbers merchants. For full details of your nearest stockist please refer to [www.kudosshowers.co.uk](http://www.kudosshowers.co.uk)

## PRICING

All prices in this brochure are inclusive of VAT at the rate of 20%. KUDOS Shower Products Ltd reserves the right to introduce changes without prior notice.

## PRODUCT SPECIFICATION AND DIMENSIONS

All dimensions are in millimetres, unless otherwise specified. Whilst every effort is taken to provide accurate information, the details contained in this brochure are for guidance purposes only. Dimensions shown are nominal and product specification is subject to change without notice. References to 'silver' relate to colour only.

## IMAGE REPRODUCTION

All images contained in this brochure are the copyright of KUDOS Shower Products Ltd and may not be reproduced in any form without prior written consent.

## USE WITH HIGH PERFORMANCE SHOWERS

References relating to product suitability for use with high performance showers assume that the showerhead is positioned appropriately for normal shower use and in the case of overbath showering does not include spray extending beyond the width of the screen. Please bear in mind the natural limitations of a door-less walk-in enclosure before fitting.

## LIFETIME GUARANTEE

All KUDOS branded products carry a lifetime guarantee against faulty workmanship or materials excluding consumables. The guarantee does not cover normal wear and tear, damage caused by misuse or problems arising from faulty installation or any damage or defects to glass once assembly / installation has commenced. The guarantee is valid only for the original purchaser and is not transferable. Proof of purchase may be required for a claim under guarantee. The guarantee covers the product only; KUDOS cannot accept responsibility for subsequential loss or damage. For full details of our guarantee please visit [www.kudosshowers.co.uk](http://www.kudosshowers.co.uk)

## LIFESHIELD™ GLASS PROTECTION

The first permanent protection system for glass comes as standard on all KUDOS products. Lifeshield™ use the very latest nanotechnology to deliver a unique bond with the glass that leaves the surface totally smooth and helps to resist the build-up of unsightly limescale and soap deposits. Totally clear, UV stable and extremely durable, Lifeshield™ won't peel or flake. Unlike some other systems you don't really need any specialist cleaners or top-up products to maintain its' direct repellent properties.

# K

KUDOS

# Planner

1000mm

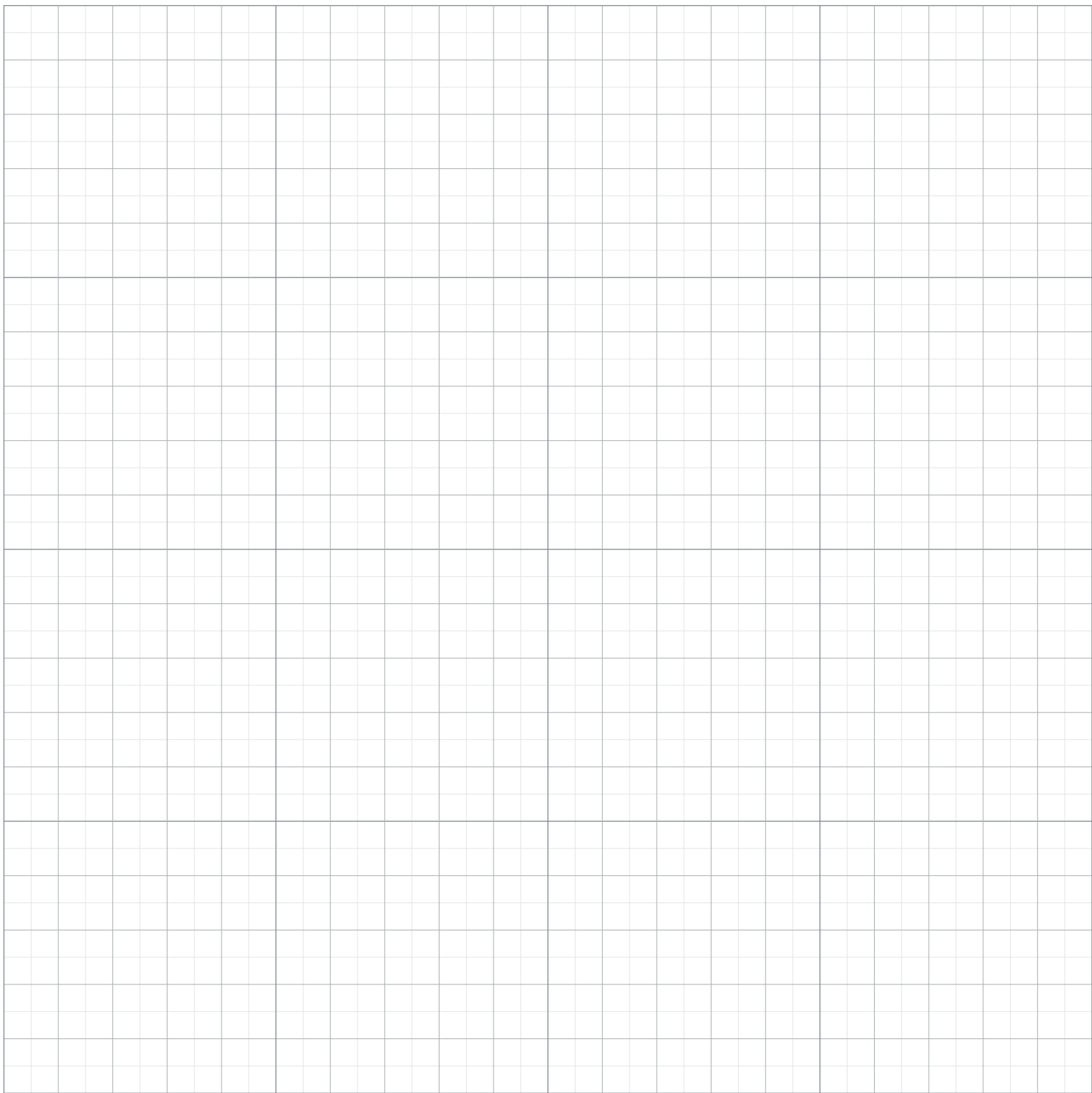







## Kudos Shower Products Ltd

Elmsfield Park, Holme, Cumbria, LA6 1RJ

t: 01539 564040

f: 01539 564141

e: [info@kudosshowers.co.uk](mailto:info@kudosshowers.co.uk)

w: [kudosshowers.co.uk](http://kudosshowers.co.uk)

Ref: THECOLLECTIONJAN2018 | E.&O.E