





CONTENTS

004 THE CHOICE IS YOURS

006 TRADITIONAL TASTES

008 MODERN & MINIMAL

010 CERAMIC SINKS

034 GRANITE SINKS

048 GLASS SINKS

052 STAINLESS STEEL SINKS

090 SINK ACCESSORIES

094 WHAT'S YOUR TYPE?

096 THE INSIDE STORY

098 STAINLESS STEEL

100 VAPOS 3IN1 STEAMING WATER TAP

104 PURITI FILTER TAPS

110 PULL-OUT AND SPRAY TAPS

118 SINGLE CONTROL TAPS

129 DUAL CONTROL TAPS

138 FOOD WASTE DISPOSAL

YOUR HOME YOUR STYLE

The finishing touches can make all the difference when it comes to creating your dream kitchen. Caple sinks are made in ceramic, granite, glass or stainless steel and our taps range from the classic to the hi-tech. They bring your kitchen to life by combining practicality with style, whatever your taste or budget.

Whatever kitchen design you've decided on, Caple has the perfect sink and tap to set it off. Making some key decisions now will help you find just the right combination.

THE CHOICE IS YOURS



THINK ABOUT SINKS

People use sinks in many different ways. Do you require a drainer? How many bowls do you need and what sizes will be most useful? How about the space you have available? Now turn your attention to style. What will go best with your kitchen? Finally, you need to choose the finish – traditional ceramic, contemporary stainless steel, luxurious glass or practical granite?

TIME TO TALK TAPS

With Caple, a tap is not just a tap. You need to choose the type of lever, whether you want purified water or a pull-out spray head? Or perhaps a 3in1 tap with steaming hot water when ever you need it? And, what do you want your tap to look like? The section on tap types and styles on pages 90-95 will help you. From the visually striking to the practical and easy to use, there's a tap for everyone.

CE Caple products are manufactured to the highest standards, all of our sinks are tested to BS EN 13310:2015 and CE certified.



UNDERMOUNTED SINKS

Mounted beneath the worktop, which is cut to fit the size of the bowl. A distinctive, fully integrated look in ceramic, granite and stainless steel. Taps are usually mounted into the worktop behind the sink. Granite, solid surface or wooden worktops are compatible with undermounted sinks.



INSET SINKS

The feature lip around the sink's edge fits on top of the worktop. With finishes available in ceramic, granite, glass and stainless steel. Taps are fitted to the sink itself, however, individual bowls may require the tap to be mounted into the worktop. Granite, solid surface, wooden or laminate worktops can be used with inset sinks.



FARMHOUSE SINKS

They can be installed under the worktop with the front face visible – to accommodate the depth, you'll need a short height cabinet. A period Victorian design – traditionally ceramic. Usually mounted into the worktop, although some sink models allow for them to be fitted to the sink. Granite, solid surface or wooden.

TRADITIONAL TASTES

Often the heart of the home, the traditional kitchen is warm and inviting. With elegant detailing and subtle design elements it has a comforting, old world charm.



AN ABSOLUTE CLASSIC

If your kitchen is traditional or country style, you can't go wrong with a classic ceramic. You can choose from the ever-popular and practical farmhouse style to more subtle and sophisticated designs in many shapes and sizes.

SUITABLY SIZED

They don't come more traditional than the generously proportioned sit-on sinks. Or a smooth and sophisticated inset design might be more to your taste. Whichever you choose, ceramic sinks are hardwearing and easy to maintain with their smooth, gleaming white glaze.

ESPECIALLY FOR YOU

Caple ceramic sinks are manufactured using time-aged methods and materials, making every one unique.

MODERN TWIST

Although ceramic sinks are notably traditional in appearance they are also beautifully adaptable. Why not pair a single bowl Belfast with a contemporary single lever tap to give a fresh take on a classic look.



MODERN AND MINIMAL

The last thing you want from the kitchen you choose today is for it to go out of fashion tomorrow. But smartly designed contemporary styling retains its freshness through clean lines, bold colour and striking aesthetics. Where do you start when choosing a contemporary sink and tap?



NATURALLY GOOD LOOKING

The practical granite sink has become a style icon. Quite right too, as it offers you immense durability, and comes in an array of glamorous colours.

SLEEK STAINLESS STEEL

Quickly being fashioned into ever more inspired and imaginative designs. Its sleek lines and neutral finish complement many colour schemes and appliances.



PROFESSIONAL PULL-OUTS

Go for an industrial look with a pull-out or choose a slim line curved tap for that fresh, contemporary feel. Modern styling is all about contrasts so you can mix and match to your heart's content.

PICK AND MIX

In the spirit of modernity, why not combine different shapes and sizes? Mix bowls together to reflect your individuality and add the ultimate designer tap for a real talking point.

Ceramic Sinks

At home in any kitchen, a ceramic sink offers you the simple elegance of a bygone era, yet can look the part in the most contemporary settings.



FARMHOUSE SINKS

These time-honoured classics will stand the test of time in today's busy kitchen. Their generous proportions are perfect if you want to make a sizeable design statement.



SITTING PRETTY

The Lingfield [above] gives you the option to have a farmhouse style sink which works perfectly with laminate and solid wood worktops. This clever design gives a traditional Butler appearance from the front and protects the cut edges of the work surface from water by using a lip on the sides and rear. It is also simple to install as no bespoke cabinetry is required.



A selection of our handmade ceramic sinks are specially glazed to reduce surface bacteria by 99.99% preventing germs from spreading. Unlike a thin coating, the anti-bacterial glaze will last the lifetime of the sink and is safe to use in every environment.

ACCESSORIZE

Ceramic by nature is hard-wearing but to avoid any accidents protect the base of the bowl with a perfectly fitting sink grid.

Note: Each sink is hand finished, so no two sinks are ever alike – sizes may vary by plus-or-minus 2%. We recommend measuring the actual sink before fitting.

CERAMIC DRAINER



PRODUCT CODE
CPDRAINER

FINISH AVAILABLE

White

FEATURES

- White
- Freestanding to sit on counter top
- Fluted design
- Weight 20kg
- Hygiene finish

BELFAST 600 SIT-ON



PRODUCT CODE
CPBS

FINISH AVAILABLE

White

FEATURES

- Reversible
- No tap facility
- 65mm waste outlet
- Weir overflow
- Hygiene finish
- waste to be ordered separately

PLUMBING OPTIONS

- Stainless steel waste CAP/PW/SS3
- Chrome waste CAP/SL/CH
- Plumbing kit CPK100

ACCESSORY OPTIONS



Universal wooden chopping board CBB3040



Universal wooden chopping board CCB2



Stainless steel sink grid CGRIDS

SINKS

I2

I3

CERAMIC

DIMENSIONS

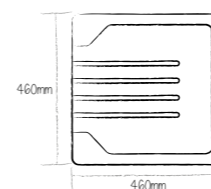

Note: All sink dimensions may vary by plus-or-minus 2%.

DIMENSIONS

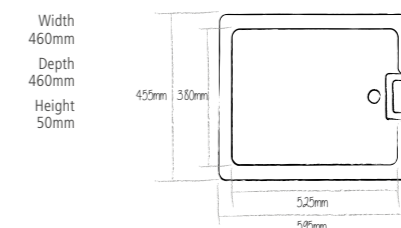

Note: All sink dimensions may vary by plus-or-minus 2%.

**BELFAST 915
SIT-ON**



PRODUCT CODE
CPBS36

FINISH AVAILABLE

White

FEATURES

- Reversible
- No tap facility
- 65mm waste outlet
- Weir overflow
- Hygiene finish
waste to be ordered separately

PLUMBING OPTIONS

- Stainless steel waste CAP/PW/SS3
- Chrome waste CAP/SL/CH
- Plumbing kit CPK100

ACCESSORY
OPTIONS



Universal wooden chopping board
CBB3040



Universal wooden chopping board
CCB2

**BELFAST 760
SIT-ON**



PRODUCT CODE
CPBS760

FINISH AVAILABLE

White

FEATURES

- No tap facility
- 90mm waste outlet for a basket strainer waste
- Suitable for a waste disposer
- Hygiene finish
waste to be ordered separately

PLUMBING OPTIONS

- Stainless steel waste BSW/OF/SS3
- Plumbing kit CPK100

ACCESSORY
OPTIONS



Universal wooden chopping board
CBB3040



Universal wooden chopping board
CCB2



Basket strainer waste decorative cover
CWC2

**LINGFIELD
INSET BUTLER**



PRODUCT CODE
LINGFIELD

FINISH AVAILABLE

White

FEATURES

- No tap facility
- 90mm waste outlet for a basket strainer waste
- Suitable for a waste disposer
- Hygiene finish
- Sides and back with inset lip and exposed front
waste to be ordered separately

PLUMBING OPTIONS

- Stainless steel waste kit with overflow CPK501
- Plumbing kit CPK100

ACCESSORY
OPTIONS



Universal wooden chopping board
CBB3040



Universal wooden chopping board
CCB2



Stainless steel sink grid
CGRID2

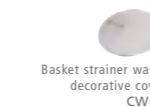

Basket strainer waste decorative cover
CWC2

**BUTLER
600 SIT-ON**



PRODUCT CODE
CPBS600

FINISH AVAILABLE

White

FEATURES

- No tap facility
- 90mm waste outlet for a basket strainer waste
- Suitable for a waste disposer
- Hygiene finish
- Includes chrome overflow
waste to be ordered separately

PLUMBING OPTIONS

- Stainless steel waste BSW/OF/SS3
- Plumbing kit CPK100

ACCESSORY
OPTIONS



Universal wooden chopping board
CBB3040



Universal wooden chopping board
CCB2



Stainless steel sink grid
CGRID2



Basket strainer waste decorative cover
CWC2

↔ DIMENSIONS

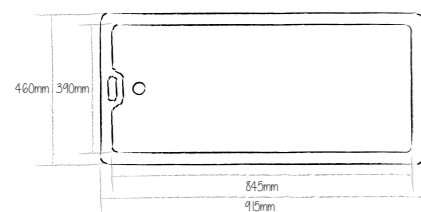

Note: All sink dimensions may vary by plus-or-minus 2%.

↔ DIMENSIONS

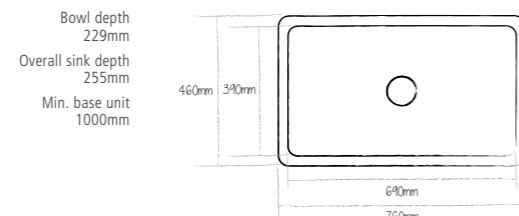

Note: All sink dimensions may vary by plus-or-minus 2%.

↔ DIMENSIONS

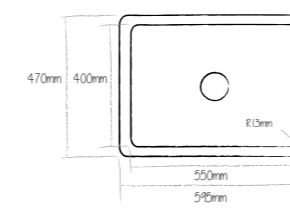

Note: All sink dimensions may vary by plus-or-minus 2%.

↔ DIMENSIONS

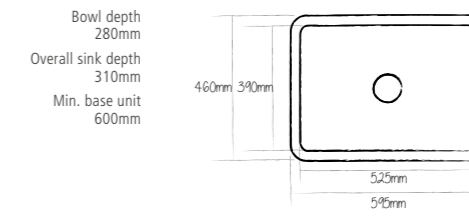

Note: All sink dimensions may vary by plus-or-minus 2%.

Sink tapers from top to bottom by approx. 4mm

**BUTLER 800
SIT-ON**

**HYGIENE
FINISH**



PRODUCT CODE
CPBS800

FINISH AVAILABLE

White

FEATURES

- No tap facility
- 90mm waste outlet for a basket strainer waste
- Suitable for a waste disposer
- Hygiene finish
- Includes chrome overflow waste to be ordered separately

PLUMBING OPTIONS

- Stainless steel waste BSW/OF/SS3
- Plumbing kit CPK100

ACCESSORY OPTIONS



Universal wooden chopping board CBB3040



Universal wooden chopping board CCB2



Stainless steel sink grid CGRID1



Basket strainer waste decorative cover CWC2

**FARMHOUSE 762
SIT-ON**

**HYGIENE
FINISH**



PRODUCT CODE
CPWDS762

FINISH AVAILABLE

White

FEATURES

- No tap facility
- 90mm waste outlet for a basket strainer waste
- Suitable for a waste disposer
- Hygiene finish
- waste to be ordered separately

PLUMBING OPTIONS

- Stainless steel waste BSW/OF/SS3
- Plumbing kit CPK100

ACCESSORY OPTIONS



Universal wooden chopping board CBB3040



Universal wooden chopping board CCB2

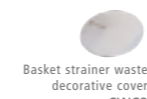

Basket strainer waste decorative cover CWC2

**YORKSHIRE
SIT-ON**

**HYGIENE
FINISH**



PRODUCT CODE
YORK

FINISH AVAILABLE

White

FEATURES

- No tap facility
- 90mm waste outlet for a basket strainer waste
- Suitable for a waste disposer
- waste to be ordered separately

PLUMBING OPTIONS

- Stainless steel waste and overflow CPK1501
- Brushed steel waste and overflow CPK2500
- Chrome waste and overflow CPK1900
- Plumbing kit CPK100

ACCESSORY OPTIONS



Universal wooden chopping board CBB3040



Universal wooden chopping board CCB2

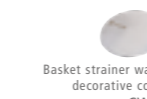

Basket strainer waste decorative cover CWC2

**PEMBERLEY
SIT-ON**

**HYGIENE
FINISH**



PRODUCT CODE
PEMBERLEY

FINISH AVAILABLE

White

FEATURES

- No tap facility
- 90mm waste outlet for a basket strainer waste
- Suitable for a waste disposer
- Hygiene finish
- Includes chrome overflow waste to be ordered separately

PLUMBING OPTIONS

- Stainless steel waste BSW/OF/SS3
- Plumbing kit CPK100

ACCESSORY OPTIONS



Universal wooden chopping board CBB3040



Universal wooden chopping board CCB2



Stainless steel sink grid CGRID4



Basket strainer waste decorative cover CWC2

DIMENSIONS

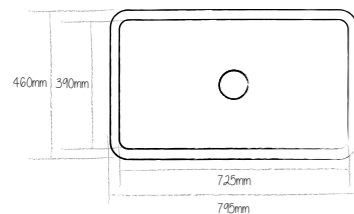

Bowl depth 229mm
Overall sink depth 255mm
Min. base unit 800mm

Sink tapers from top to bottom by approx. 4mm

Note: All sink dimensions may vary by plus-or-minus 2%.

DIMENSIONS

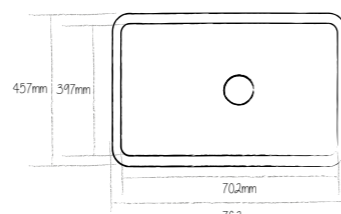

Bowl depth 254mm
Overall sink depth 284mm
Min. base unit 800mm

Note: All sink dimensions may vary by plus-or-minus 2%.

DIMENSIONS

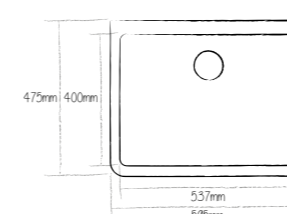

Note: All sink dimensions may vary by plus-or-minus 2%.

DIMENSIONS

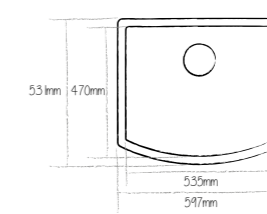

Bowl depth 195mm
Overall sink depth 225mm
Min. base unit 600mm

Sink tapers from top to bottom by approx. 20mm

Note: All sink dimensions may vary by plus-or-minus 2%.

**BUTLER 600TL
SIT-ON**



PRODUCT CODE
CPBS600TL

FINISH AVAILABLE

White

FEATURES

- Tap ledge with bridge tap facility
 - 2 punched tap holes
 - 90mm waste outlet for a basket strainer waste
 - Suitable for a waste disposer
 - Hygiene finish
- waste to be ordered separately

PLUMBING OPTIONS

- Stainless steel waste BSW/OF/SS3
- Plumbing kit CPK100

ACCESSORY OPTIONS



**CHEPSTOW
SIT-ON**



PRODUCT CODE
CHEPSTOW

FINISH AVAILABLE

White

FEATURES

- 1 Semi-punched tap hole
 - 2 90mm waste outlets for basket strainer wastes
 - Suitable for a waste disposer
 - Hygiene finish
- wastes to be ordered separately

PLUMBING OPTIONS

- Stainless steel waste and overflow CPK501 [x2]
- Plumbing kit CPK200

ACCESSORY OPTIONS



**KEMPTON
SIT-ON**



PRODUCT CODE
KEMPTON

FINISH AVAILABLE

White

FEATURES

- No tap facility
 - 2 90mm waste outlets for basket strainer wastes
 - Suitable for a waste disposer
 - Hygiene finish
 - Includes chrome overflows
- wastes to be ordered separately

PLUMBING OPTIONS

- Stainless steel waste BSW/OF/SS3 [x2]
- Plumbing kit CPK200

ACCESSORY OPTIONS



↔ DIMENSIONS

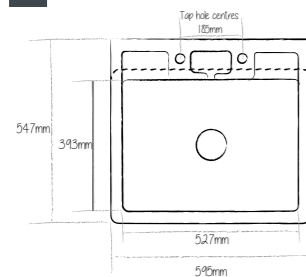

Note: All sink dimensions may vary by plus-or-minus 2%.

↔ DIMENSIONS

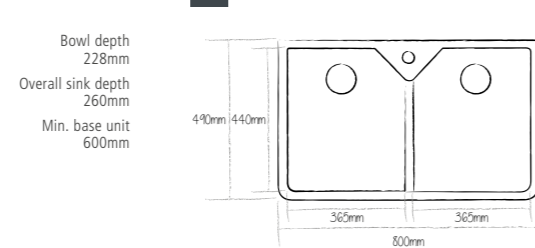

Note: All sink dimensions may vary by plus-or-minus 2%.

↔ DIMENSIONS

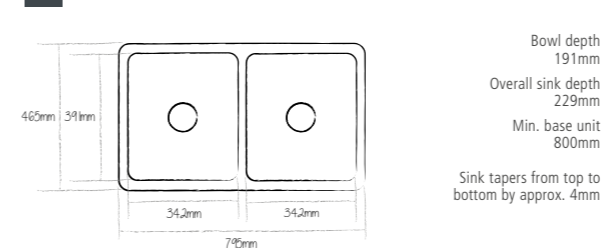

Note: All sink dimensions may vary by plus-or-minus 2%.

UNDERMOUNTED AND INSET SINKS

Choose from inset or undermounted ceramic sinks to make a distinctive style statement. A classic yet contemporary look that exudes elegance and fits easily into many different styles of kitchen.



DESIGNER DRAINING

The design of the drainer pattern can have a dramatic impact on the overall look of the sink. For a flat, modern style, go for our Avalon sinks. If you want something softer, how about the Foxboro range?

KEEP ON TOP OF IT

With their gently raised lip and smooth lines, inset sinks blend subtly and discreetly onto your worktop surface. Available in many shapes and sizes, this versatile style drops seamlessly into any kitchen.

UNDERSTATED STYLE

Fully integrated beneath the worktop, undermounted sinks give a very distinctive look to your kitchen. Used with granite, solid surface or wood worktops.



A selection of our handmade ceramic sinks are specially glazed to reduce surface bacteria by 99.99% preventing germs from spreading. Unlike a thin coating, the anti-bacterial glaze will last the lifetime of the sink and is safe to use in every environment.



Note: Each sink is hand finished, so no two sinks are ever alike – sizes may vary by plus-or-minus 2%.
We recommend measuring the actual sink before fitting.

**ASHFORD 100
INSET WITH DRAINER**



PRODUCT CODE
ASH1W

FINISH AVAILABLE

White

FEATURES

- Reversible
- 2 Semi-punched tap holes
- 90mm waste outlet for a basket strainer waste
- Suitable for a waste disposer waste to be ordered separately

PLUMBING OPTIONS

- Stainless steel waste and overflow CPK501
- Plumbing kit CPK100

ACCESSORY OPTIONS



**ASHFORD 150
INSET WITH DRAINER**



PRODUCT CODE
ASH15W

FINISH AVAILABLE

White

FEATURES

- Reversible
- Overflow will be at the front if reversed
- 4 Semi-punched tap holes
- 2 90mm waste outlets for basket strainer wastes
- Suitable for a waste disposer wastes to be ordered separately

PLUMBING OPTIONS

- Stainless steel waste, bowl connection kit and overflow CPK801
- Plumbing kit CPK100

ACCESSORY OPTIONS



**AVALON 100
INSET WITH DRAINER**



PRODUCT CODE

AVA1W/L - Left handed drainer
AVA1W/R - Right handed drainer

FINISH AVAILABLE

White

FEATURES

- Left or right handed drainer
- 2 Semi-punched tap holes, 1 punched [centre]
- 90mm waste outlet for a basket strainer waste
- Suitable for a waste disposer waste to be ordered separately

PLUMBING OPTIONS

- Stainless steel waste and overflow CPK501
- Plumbing kit CPK100

ACCESSORY OPTIONS

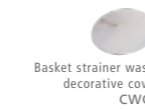

**AVALON 150
INSET WITH DRAINER**



PRODUCT CODE

AVA15W/L - Left handed drainer
AVA15W/R - Right handed drainer

FINISH AVAILABLE

White

FEATURES

- Left or right handed drainer
- 2 Semi-punched tap holes, 1 punched [centre]
- 2 90mm waste outlets for basket strainer wastes
- Suitable for a waste disposer wastes to be ordered separately

PLUMBING OPTIONS

- Stainless steel waste, bowl connection kit and overflow CPK801
- Plumbing kit CPK100

ACCESSORY OPTIONS



DIMENSIONS

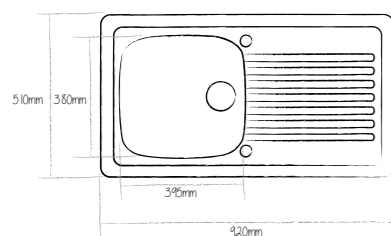

Note: All sink dimensions may vary by plus-or-minus 2%.

DIMENSIONS

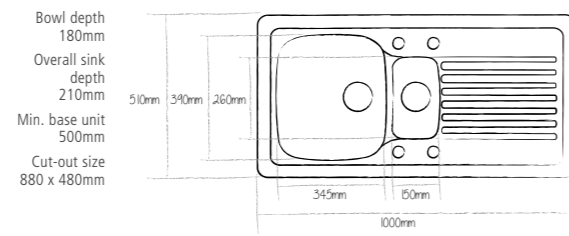

Note: All sink dimensions may vary by plus-or-minus 2%.

DIMENSIONS

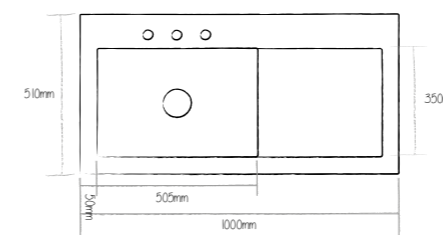

Note: All sink dimensions may vary by plus-or-minus 2%.

DIMENSIONS

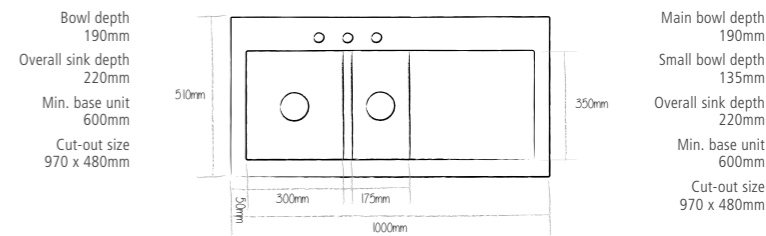

Note: All sink dimensions may vary by plus-or-minus 2%.

**AVALON 100
INSET WITH DRAINER**



PRODUCT CODE
AVA1B/L - Left handed drainer
AVA1B/R - Right handed drainer

FINISH AVAILABLE
■ Black

- FEATURES**
- Left or right handed drainer
 - 2 Semi-punched tap holes, 1 punched [centre]
 - 90mm waste outlet for a basket strainer waste
 - Suitable for a waste disposer waste to be ordered separately

- PLUMBING OPTIONS**
- Stainless steel waste and overflow CPK501
 - Plumbing kit CPK100

ACCESSORY OPTIONS



**AVALON 150
INSET WITH DRAINER**



PRODUCT CODE
AVA15B/L - Left handed drainer
AVA15B/R - Right handed drainer

FINISH AVAILABLE
■ Black

- FEATURES**
- Left or right handed drainer
 - 2 Semi-punched tap holes, 1 punched [centre]
 - 2 90mm waste outlets for basket strainer wastes
 - Suitable for a waste disposer wastes to be ordered separately

- PLUMBING OPTIONS**
- Stainless steel waste, bowl connection kit and overflow CPK801
 - Plumbing kit CPK100

ACCESSORY OPTIONS



**WILTSHIRE 100
INSET WITH DRAINER**



PRODUCT CODE
WIL100

FINISH AVAILABLE
□ White

- FEATURES**
- Reversible
 - 2 Semi-punched tap holes
 - 90mm waste outlet for a basket strainer waste
 - Suitable for a waste disposer waste to be ordered separately

- PLUMBING OPTIONS**
- Stainless steel waste and overflow CPK501
 - Plumbing kit CPK100

ACCESSORY OPTIONS

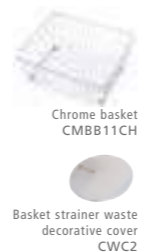

**WILTSHIRE 150
INSET WITH DRAINER**



PRODUCT CODE
WIL150

FINISH AVAILABLE
□ White

- FEATURES**
- Reversible
 - 2 Semi-punched tap holes
 - 2 90mm waste outlets for basket strainer wastes
 - Suitable for a waste disposer wastes to be ordered separately

- PLUMBING OPTIONS**
- Stainless steel waste kit and overflow CPK2701
 - Plumbing kit CPK200

ACCESSORY OPTIONS



DIMENSIONS

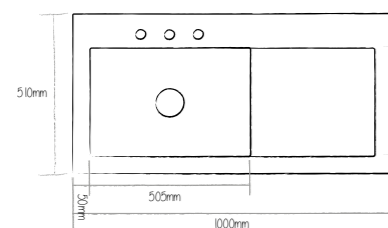

Bowl depth 190mm
Overall sink depth 220mm
Min. base unit 600mm
Cut-out size 970 x 480mm

Note: All sink dimensions may vary by plus-or-minus 2%.

DIMENSIONS

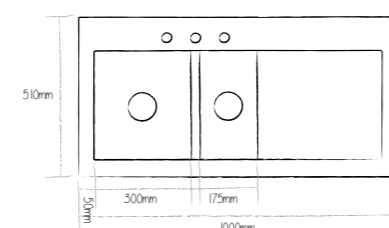

Main bowl depth 190mm
Small bowl depth 135mm
Overall sink depth 220mm
Min. base unit 600mm
Cut-out size 970 x 480mm

Note: All sink dimensions may vary by plus-or-minus 2%.

DIMENSIONS

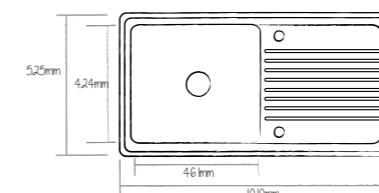

Bowl depth 190mm
Overall sink depth 225mm
Min. base unit 600mm
Cut-out size 970 x 494mm

Carcase may need to be adapted to accommodate tap tails if using a 600mm carcase
Note: All sink dimensions may vary by plus-or-minus 2%.

DIMENSIONS

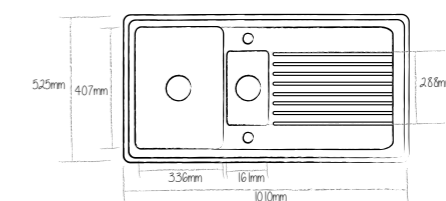

Main bowl depth 180mm
Small bowl depth 110mm
Overall sink depth 223mm
Min. base unit 600mm
Cut-out size 972 x 495mm

Note: All sink dimensions may vary by plus-or-minus 2%.

**FOXBORO 100
INSET WITH DRAINER**



PRODUCT CODE
FOX100

FINISH AVAILABLE

White

FEATURES

- Reversible [Overflow will be at the front of the right hand drainer]
- 2 Semi-punched tap holes
- 90mm waste outlet for a basket strainer waste
- Suitable for a waste disposer waste to be ordered separately

PLUMBING OPTIONS

- Stainless steel waste and overflow CPK501
- Plumbing kit CPK100

ACCESSORY OPTIONS



**FOXBORO 150
INSET WITH DRAINER**



PRODUCT CODE
FOX150

FINISH AVAILABLE

White

FEATURES

- Reversible
- 2 Semi-punched tap holes
- 2 90mm waste outlets for basket strainer wastes
- Suitable for a waste disposer wastes to be ordered separately

PLUMBING OPTIONS

- Stainless steel waste kit and overflow CPK2701
- Plumbing kit CPK200

ACCESSORY OPTIONS



**PALADIN 150
INSET OR UNDERMOUNTED**



PRODUCT CODE
PAL150

FINISH AVAILABLE

White

FEATURES

- Not reversible
- No tap facility
- 2 90mm waste outlets for basket strainer wastes
- Suitable for a waste disposer wastes to be ordered separately
- Hygiene finish wastes to be ordered separately

PLUMBING OPTIONS

- Stainless steel waste and bowl connection kit CPK801
- Plumbing kit CPK100

ACCESSORY OPTIONS

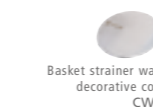

**PALADIN 760
INSET OR UNDERMOUNTED**



PRODUCT CODE
PAL760

FINISH AVAILABLE

White

FEATURES

- Not reversible
- No tap facility
- 2 90mm waste outlets for basket strainer wastes
- Suitable for a waste disposer wastes to be ordered separately
- Hygiene finish wastes to be ordered separately

PLUMBING OPTIONS

- Stainless steel waste kit with overflow CPK2701
- Plumbing kit CPK200

ACCESSORY OPTIONS



↔ DIMENSIONS

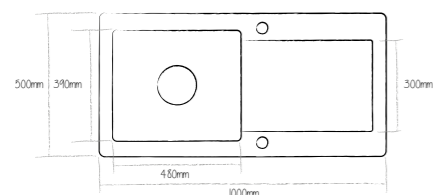

↔ DIMENSIONS

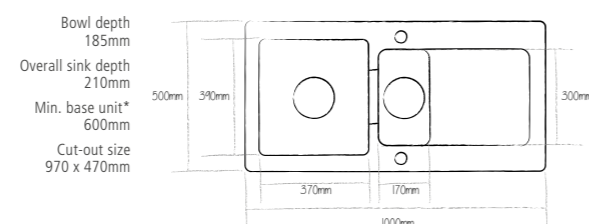

↔ DIMENSIONS

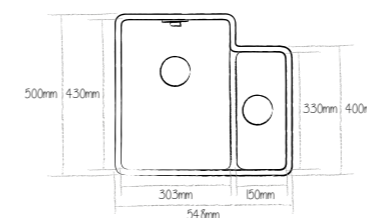

↔ DIMENSIONS

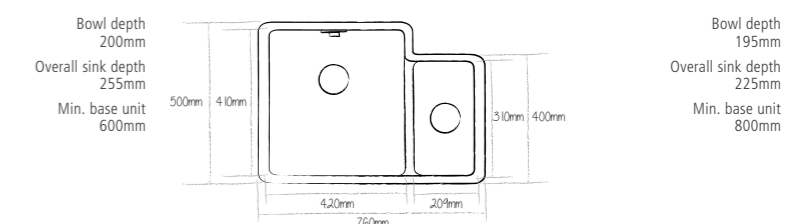

*Carcase may need to be adapted to accommodate tap tails if using a 600mm carcase
Note: All sink dimensions may vary by plus-or-minus 2%.

Note: All sink dimensions may vary by plus-or-minus 2%.

Note: All sink dimensions may vary by plus-or-minus 2%.

Note: All sink dimensions may vary by plus-or-minus 2%.

**FRISKA
UNDERMOUNTED**



PRODUCT CODE
FRI150U

FINISH AVAILABLE

White

FEATURES

- Not reversible
- No tap facility
- 90mm and 65mm waste outlets for wastes
- Suitable for a waste disposer wastes to be ordered separately

PLUMBING OPTIONS

- Stainless steel waste and bowl connection kit CPK1100
- Plumbing kit CPK100

↔ DIMENSIONS

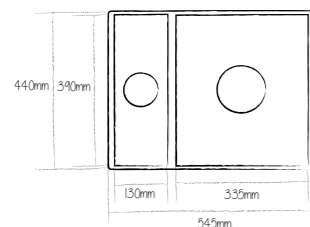

Note: All sink dimensions may vary by plus-or-minus 2%.

**ETTRA 150
UNDERMOUNTED**



PRODUCT CODE
ETT150U

FINISH AVAILABLE

White

FEATURES

- Not reversible
- No tap facility
- 90mm and 65mm waste outlets for wastes
- Suitable for a waste disposer wastes to be ordered separately

PLUMBING OPTIONS

- Stainless steel waste and bowl connection kit CPK1100
- Plumbing kit CPK100

↔ DIMENSIONS

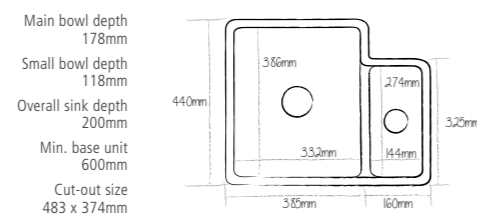

Note: All sink dimensions may vary by plus-or-minus 2%.

ACCESSORY
OPTIONS



Universal wooden chopping board
CBB3040



Universal wooden chopping board
CCB2



Basket strainer waste decorative cover
CWC2

ACCESSORY
OPTIONS



Universal wooden chopping board
CBB3040



Universal wooden chopping board
CCB2



Chrome sink grid
CGRID6



Chrome basket
CSB3CH



Chrome basket
CMBB31CH



Basket strainer waste decorative cover
CWC2

INDIVIDUAL BOWLS

Round, square, rectangular, there's a shape and size to complement your kitchen perfectly. Or pair two bowls of your choice for a unique style.



Our elegantly proportioned individual ceramic bowls are more than just practical and hardwearing. They give you complete design flexibility, so you can choose the size, shape and number of bowls to suit

your lifestyle. For a clean and classic look, try our traditional round bowl. For something chic and contemporary, how about a single ceramic bowl pair with a stainless steel tap?

**SQUARE BOWL
INSET OR UNDERMOUNTED**

**HYGIENE
FINISH**



PRODUCT CODE
CSQB

FINISH AVAILABLE

White

FEATURES

- No tap facility
- 90mm waste outlet for a basket strainer waste
- Suitable for a waste disposer
- Hygiene finish
- Includes chrome overflow waste to be ordered separately

PLUMBING OPTIONS

- Stainless steel waste BSW/OF/SS3
- Plumbing kit CPK100

FITTING OPTIONS



Inset Undermounted

DIMENSIONS

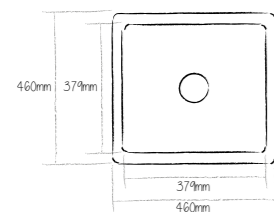

Note: All sink dimensions may vary by plus-or-minus 2%.

**CHESHIRE
INSET OR UNDERMOUNTED**

**HYGIENE
FINISH**



PRODUCT CODE
CPCIB2

FINISH AVAILABLE

White

FEATURES

- No tap facility
- 90mm waste outlet for a basket strainer waste
- Suitable for a waste disposer
- Hygiene finish
- waste to be ordered separately

PLUMBING OPTIONS

- Stainless steel waste and overflow CPK501
- Plumbing kit CPK100

FITTING OPTIONS



Inset Undermounted

DIMENSIONS

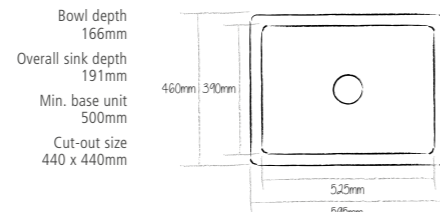

Note: All sink dimensions may vary by plus-or-minus 2%.

**HAMPSHIRE
INSET OR UNDERMOUNTED**



PRODUCT CODE
HAMPSHIRE

FINISH AVAILABLE

White

FEATURES

- No tap facility
- 90mm waste outlet for a basket strainer waste
- Suitable for a waste disposer
- waste to be ordered separately

PLUMBING OPTIONS

- Stainless steel waste and overflow CPK1501
- Brushed steel waste and overflow CPK2500
- Chrome waste and overflow CPK1900
- Plumbing kit CPK100

FITTING OPTIONS

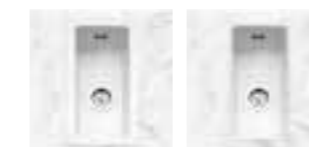

Inset Undermounted

DIMENSIONS

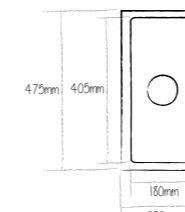

Note: All sink dimensions may vary by plus-or-minus 2%.

**BERKSHIRE
INSET OR UNDERMOUNTED**



PRODUCT CODE
BERKSHIRE

FINISH AVAILABLE

White

FEATURES

- No tap facility
- 90mm waste outlet for a basket strainer waste
- Suitable for a waste disposer
- waste to be ordered separately

PLUMBING OPTIONS

- Stainless steel waste and overflow CPK1501
- Brushed steel waste and overflow CPK2500
- Chrome waste and overflow CPK1900
- Plumbing kit CPK100

FITTING OPTIONS

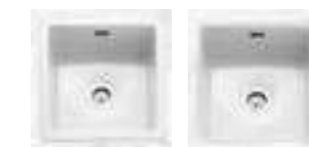

Inset Undermounted

DIMENSIONS

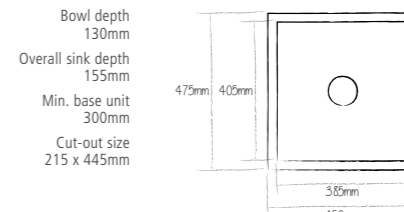

Note: All sink dimensions may vary by plus-or-minus 2%.

**ACCESSORY
OPTIONS**



Universal wooden chopping board CBB3040



Universal wooden chopping board CCB2



Basket strainer waste decorative cover CWC2

**ETTRA 600
UNDERMOUNTED**



PRODUCT CODE
ETT600U

FINISH AVAILABLE

White

FEATURES

- No tap facility
- 90mm waste outlet for a basket strainer waste
- Suitable for a waste disposer waste to be ordered separately

PLUMBING OPTIONS

- Stainless steel waste and bowl connection kit CPK501
- Plumbing kit CPK100

↔ DIMENSIONS

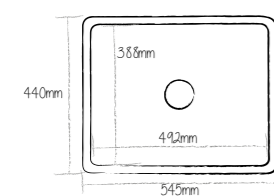

Note: All sink dimensions may vary by plus-or-minus 2%.

**WARWICKSHIRE
INSET OR UNDERMOUNTED**

**HYGIENE
FINISH**



PRODUCT CODE
CPWIB2

FINISH AVAILABLE

White

FEATURES

- No tap facility
- 90mm waste outlet for a basket strainer waste
- Suitable for a waste disposer waste to be ordered separately
- Hygiene finish

PLUMBING OPTIONS

- Stainless steel waste and overflow CPK501
- Plumbing kit CPK100

FITTING OPTIONS

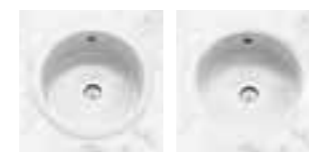

Inset

Undermounted

↔ DIMENSIONS

Bowl depth
176mm
Overall sink depth
200mm
Min. base unit
600mm

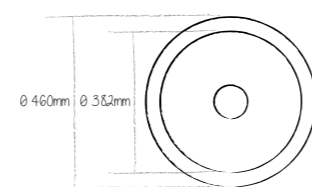

Note: All sink dimensions may vary by plus-or-minus 2%.

ACCESSORY
OPTIONS



Universal wooden chopping board
CBB3040



Universal wooden chopping board
CCB2

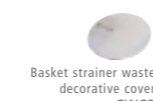

Basket strainer waste decorative cover
CWC2



Granite Sinks

These are practical and beautiful sinks to cope with the demands of everyday living. Granite is synonymous with durability and can also offer you an array of stylish colours to match your décor.



MATERIAL INNOVATION

PICK A COLOUR

Our range consisting of four families are made from Geotech, which is available in four sophisticated colourways – metallic Anthracite, matt Desert sand, matt Chalk white and matt Pebble grey.



AN – Anthracite [metallic] DS – Desert sand [matt] CW – Chalk white [matt] PG – Pebble grey [matt]

Our stunning Anthracite colour is infused with a sparkling metallic fleck, guaranteed to add a touch of glamour to your kitchen. Desert sand has a warm, natural feel if you're looking for understated elegance and Chalk white's rich white tones provide the ultimate in relaxed sophistication. If you prefer a slightly industrial, yet ultra modern tone, Pebble grey is perfect to create this look.

NATURALLY GOOD LOOKING

These sinks offer the beauty of natural stone, yet can be moulded into an unlimited number of inspiring designs.

Features

KIND ON THE ENVIRONMENT

Geotech is made up of around 80% natural materials and manufactured using low energy consumption.



KEEPS ITS COLOUR

Completely colourfast, the metallic and matt colour finishes will both stay fresh and vibrant.

EASY TO CLEAN

All you need to keep Geotech sparkling is warm water and washing-up liquid.

HEAT & BURN RESISTANT

Hot pans? No problem – resistant to heat, cracking, discolouring, blistering and warping.



HIGHLY DURABLE

Produced to be extremely hard-wearing, it takes the knocks and scrapes of daily life in its stride.

STAIN RESISTANT

Geotech is resistant to permanent staining. As long as it's cleaned regularly, it won't discolour or stain.

CUT-RESISTANT

Both cut and scratch resistant, Geotech will retain its unblemished surface through thick and thin.



SOTERA INSET SINKS

Modern, minimal design made in our advanced Geotech material make Sotera a very attractive and practical combination.



With strong, straight lines the Sotera brings a bold presence to any kitchen. A simple, yet refined drainer pattern and the subtle introduction of stainless steel detail within the

bowls and drainer, enhance Sotera's undoubted feeling of quality. Available in all four Geotech colours, Anthracite, Desert sand, Chalk white and Pebble grey, the choice is yours.

SOTERA 100 INSET WITH DRAINER



[ANTHRACITE SHOWN]

PRODUCT CODE

- SOT100AN - Anthracite
- SOT100DS - Desert sand
- SOT100CW - Chalk white
- SOT100PG - Pebble grey

FINISH AVAILABLE

- Anthracite [metallic]
- Desert sand [matt]
- Chalk white [matt]
- Pebble grey [matt]

FEATURES

- Reversible
- 2 Semi-punched tap holes
- 90mm waste outlet for a basket strainer waste
- Suitable for a waste disposer
- Chrome waste, overflow and plumbing kit included
- Basket strainer waste decorative cover included [Shown above]

DIMENSIONS

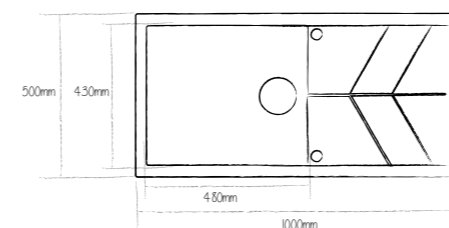

SOTERA 150 INSET WITH DRAINER



[CHALK WHITE SHOWN]

PRODUCT CODE

- SOT150AN - Anthracite
- SOT150DS - Desert sand
- SOT150CW - Chalk white
- SOT150PG - Pebble grey

FINISH AVAILABLE

- Anthracite [metallic]
- Desert sand [matt]
- Chalk white [matt]
- Pebble grey [matt]

FEATURES

- Reversible
- 2 Semi-punched tap holes
- 2 90mm waste outlets for basket strainer wastes
- Suitable for a waste disposer
- Chrome wastes, overflow and plumbing kit included
- Basket strainer waste decorative covers included [Shown above]

DIMENSIONS

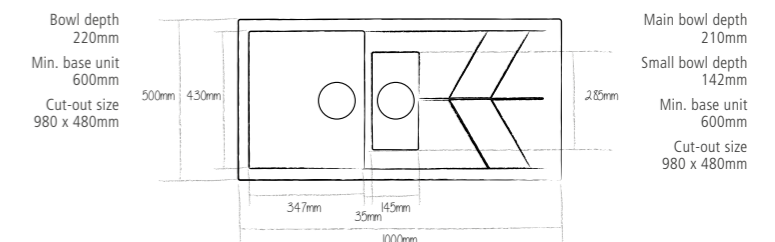

ACCESSORY OPTIONS



Glass chopping board CGCB2



Chrome basket CMBB11CH

ACCESSORY OPTIONS



Glass chopping board CGCB2



Chrome basket CMBB10CH



Chrome small bowl basket CSB3CH



CANIS INSET SINKS

Why choose just a sink when you can have a kitchen work centre? Canis is a beautifully practical idea, combining advanced material technology with precision design and aesthetics.



Elegant and architectural, Canis will look magnificent in your modern kitchen. And because it's manufactured using Geotech, Canis will retain

its exceptional looks however rough you treat it. It won't warp, cut or fade, so you can carry out your daily tasks without worrying.

CANIS 100 INSET WITH DRAINER



[ANTHRACITE SHOWN]

PRODUCT CODE

- CAN100AN - Anthracite
- CAN100DS - Desert sand
- CAN100CW - Chalk white
- CAN100PG - Pebble grey

FINISH AVAILABLE

- Anthracite [metallic]
- Desert sand [matt]
- Chalk white [matt]
- Pebble grey [matt]

FEATURES

- Reversible
- 2 Semi-punched tap holes
- 90mm waste outlet for a basket strainer waste
- Suitable for a waste disposer
- Chrome waste, overflow and plumbing kit included

←→ DIMENSIONS

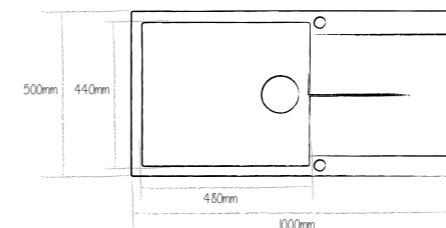

CANIS 150 INSET WITH DRAINER



[PEBBLE GREY SHOWN]

PRODUCT CODE

- CAN150AN - Anthracite
- CAN150DS - Desert sand
- CAN150CW - Chalk white
- CAN150PG - Pebble grey

FINISH AVAILABLE

- Anthracite [metallic]
- Desert sand [matt]
- Chalk white [matt]
- Pebble grey [matt]

FEATURES

- Reversible
- 2 Semi-punched tap holes
- 2 90mm waste outlets for basket strainer wastes
- Suitable for a waste disposer
- Chrome wastes, overflow and plumbing kit included

←→ DIMENSIONS

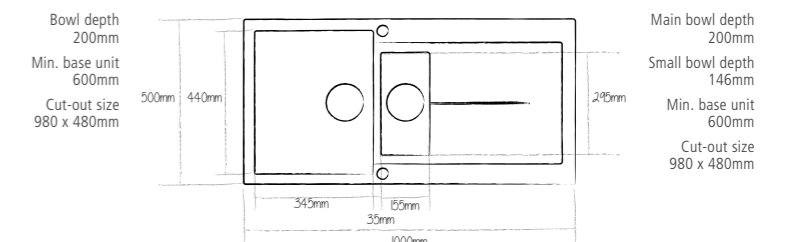

ACCESSORY OPTIONS



Glass chopping board CGCB2

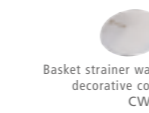

Basket strainer waste decorative cover CWC2

ACCESSORY OPTIONS



Glass chopping board CGCB2



Chrome basket CMBB10CH



Chrome sink grid CGRID6



Basket strainer waste decorative cover CWC2

SINKS

40

41

GRANITE



VEIS INSET SINKS

Looking for a durable, stylish sink with modern clean lines and subtle design hints? If so, you've found it with Veis.



A drainer pattern with simple, clean lines and bowls with subtle curves give Veis an understated but thoroughly modern feel.

Made from our hard-wearing composite material Geotech, these sinks combine style with practicality.

VEIS 100 INSET WITH DRAINER



[DESERT SAND SHOWN]

PRODUCT CODE

- VEI100AN - Anthracite
- VEI100DS - Desert sand
- VEI100CW - Chalk white
- VEI100PG - Pebble grey

FINISH AVAILABLE

-  Anthracite [metallic]
-  Desert sand [matt]
-  Chalk white [matt]
-  Pebble grey [matt]

FEATURES

- Reversible
- 2 Semi-punched tap holes
- 90mm waste outlet for a basket strainer waste
- Suitable for a waste disposer
- Chrome waste, overflow and plumbing kit included

ACCESSORY OPTIONS



Universal wooden chopping board CCB2



Chrome basket CMBB3CH



Basket strainer waste decorative cover CWC2

DIMENSIONS

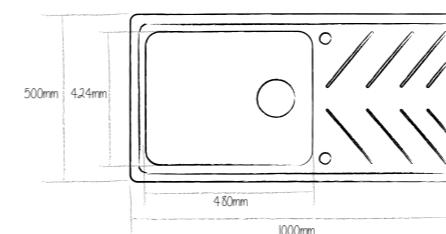

VEIS 150 INSET WITH DRAINER



[ANTHRACITE SHOWN]

PRODUCT CODE

- VEI150AN - Anthracite
- VEI150DS - Desert sand
- VEI150CW - Chalk white
- VEI150PG - Pebble grey

FINISH AVAILABLE

-  Anthracite [metallic]
-  Desert sand [matt]
-  Chalk white [matt]
-  Pebble grey [matt]

FEATURES

- Reversible
- 2 Semi-punched tap holes
- 2 90mm waste outlets for basket strainer wastes
- Suitable for a waste disposer
- Chrome wastes, overflow and plumbing kit included

ACCESSORY OPTIONS



Universal wooden chopping board CCB2



Chrome basket CMBB1CH



Chrome basket CSB1CH



Basket strainer waste decorative cover CWC2

DIMENSIONS

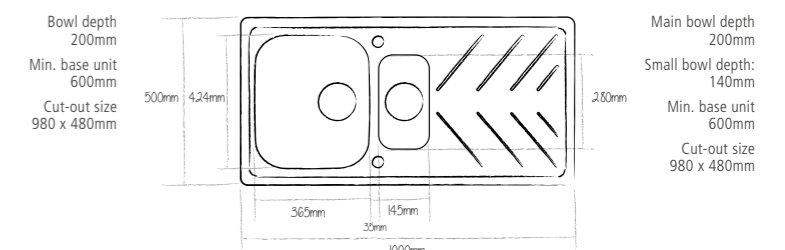

LEESTI INSET OR UNDERMOUNTED SINKS

These bowls can be inset for a statement feature or discreetly undermounted offering a truly contemporary look. Practical, versatile and stylish they look great with any worktop.



With their gracefully subtle corners and the satisfying proportions Leesti exudes elegance. Choose from a single or a bowl and a half sink,

inset or undermounted, to give you exactly what you want. For a sophisticated style, why not try two single bowls side by side?

LEESTI 600 INSET OR UNDERMOUNTED



[ANTHRACITE SHOWN]

PRODUCT CODE

- LEE600AN - Anthracite
- LEE600DS - Desert sand
- LEE600CW - Chalk white
- LEE600PG - Pebble grey

FINISH AVAILABLE

- Anthracite [metallic]
- Desert sand [matt]
- Chalk white [matt]
- Pebble grey [matt]

FEATURES

- 90mm waste outlet for a basket strainer waste
- Suitable for a waste disposer
- Chrome waste, overflow and plumbing kit included

↔ DIMENSIONS

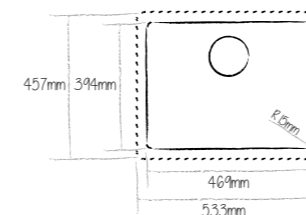

LEESTI 150U UNDERMOUNTED



[DESERT SAND SHOWN]

PRODUCT CODE

- LEE150UAN - Anthracite
- LEE150UDS - Desert sand
- LEE150UCW - Chalk white
- LEE150UPG - Pebble grey

FINISH AVAILABLE

- Anthracite [metallic]
- Desert sand [matt]
- Chalk white [matt]
- Pebble grey [matt]

FEATURES

- No tap facility tap hole
- 2 90mm waste outlets for a basket strainer wastes
- Suitable for a waste disposer
- Chrome wastes, overflow and plumbing kit included

↔ DIMENSIONS

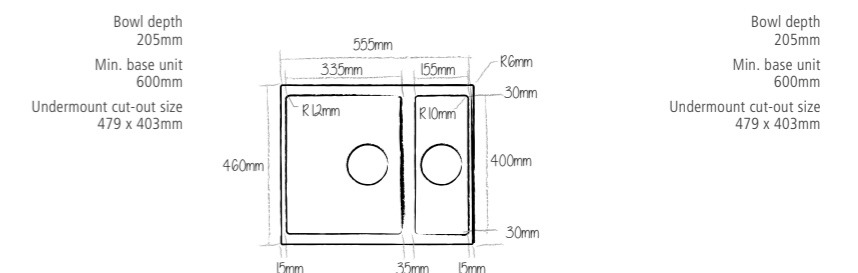

ACCESSORY OPTIONS



Universal wooden chopping board CCB2



Chrome basket CMBB3CH

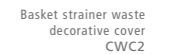

Basket strainer waste decorative cover CWC2



LEESTI 200 DOUBLE BOWL UNDERMOUNTED



[ANTHRACITE SHOWN]

PRODUCT CODE

LEE200AN	- Anthracite
LEE200DS	- Desert sand
LEE200CW	- Chalk white
LEE200PG	- Pebble grey

ACCESSORY OPTIONS



Universal wooden
chopping board
CCB2



Basket strainer waste
decorative cover
CWC2

FINISH AVAILABLE

	Anthracite [metallic]
	Desert sand [matt]
	Chalk white [matt]
	Pebble grey [matt]

FEATURES

- No tap facility tap hole
- 2 90mm waste outlets for a basket strainer wastes
- Suitable for a waste disposer
- Chrome wastes, overflow and plumbing kit included

↔ DIMENSIONS

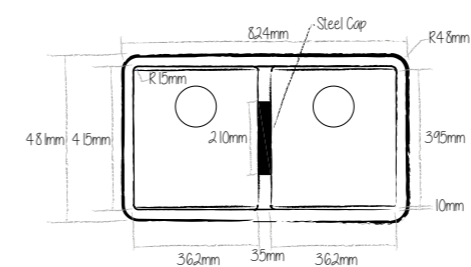

Bowl depth
240mm
Min. base unit
900mm

Glass Sinks

For a distinctively modern alternative to the traditional sink, our glass sinks are hard to surpass. Durable stainless steel bowls with fresh designs, these sinks will stand out in any kitchen.



PRACTICALLY PERFECT

Completely colourfast, the black and white finishes will keep its vibrancy and with a regular clean it won't stain or discolour. Glass is renowned for being hygienic and easy to clean, simply wash with warm

water and washing up liquid. The tempered, impact resistant glass means this makes for a strong and highly practical sink surface. Hot pans? No problem – the surface is resistant to heat

VITREA 100 INSET WITH DRAINER



PRODUCT CODE

- VT100WH/L - Left handed drainer
- VT100WH/R - Right handed drainer

FINISH AVAILABLE

- White

FEATURES

- Bowl 1.0 mm stainless steel frame 8mm tempered glass
- Glass and silk stainless steel finish
- Left or right handed drainer
- 1 Punched tap hole
- 90mm waste outlet for a basket strainer waste
- Suitable for a waste disposer
- Waste and overflow included

PLUMBING OPTION

- Plumbing kit CPK100

ACCESSORY OPTIONS



VITREA 150 INSET WITH DRAINER



PRODUCT CODE

- VT150WH/L - Left handed drainer
- VT150WH/R - Right handed drainer

FINISH AVAILABLE

- White

FEATURES

- Bowl 1.0 mm stainless steel frame 8mm tempered glass
- Glass and silk stainless steel finish
- Left or right handed drainer
- 1 Punched tap hole
- 2 90mm waste outlets for basket strainer wastes
- Suitable for a waste disposer
- Wastes, overflows and plumbing kit included

ACCESSORY OPTIONS



VITREA 100 INSET WITH DRAINER



PRODUCT CODE

- VT100BK/L - Left handed drainer
- VT100BK/R - Right handed drainer

FINISH AVAILABLE

- Black

FEATURES

- Bowl 1.0 mm stainless steel frame 8mm tempered glass
- Glass and silk stainless steel finish
- Left or right handed drainer
- 1 Punched tap hole
- 90mm waste outlet for a basket strainer waste
- Suitable for a waste disposer
- Waste and overflow included

PLUMBING OPTION

- Plumbing kit CPK100

ACCESSORY OPTIONS

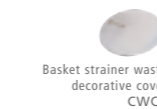

VITREA 151 INSET WITH DRAINER



PRODUCT CODE

- VT151BK/L - Left handed drainer only

FINISH AVAILABLE

- Black

FEATURES

- Bowl 1.0 mm stainless steel frame 8mm tempered glass
- Glass and silk stainless steel finish
- Left handed drainer
- 1 Punched tap hole
- 2 90mm waste outlets for basket strainer wastes
- Suitable for a waste disposer
- Wastes, overflows and plumbing kit included
- 2 waste covers included

PLUMBING OPTION

- Plumbing kit CPK100

ACCESSORY OPTIONS



DIMENSIONS

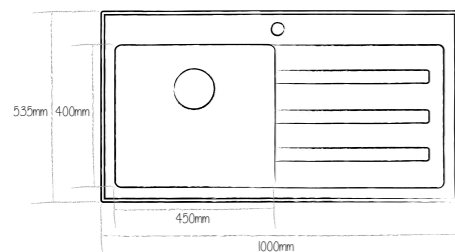

DIMENSIONS

- Bowl depth 200mm
- Min. base unit 600mm
- Cut-out size 964 x 499mm

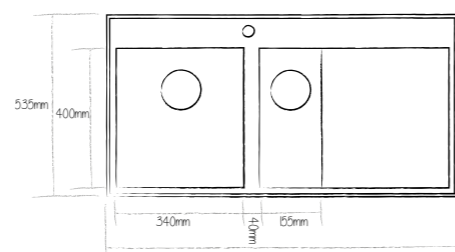

- Main bowl depth 200mm
- Small bowl depth 150mm
- Min. base unit 600mm
- Cut-out size 964 x 499mm

DIMENSIONS

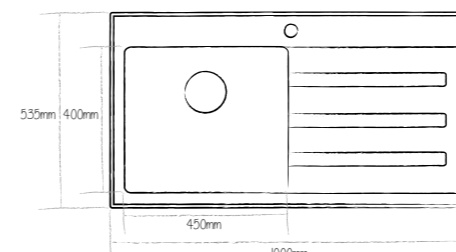

- Bowl depth 200mm
- Min. base unit 600mm
- Cut-out size 964 x 499mm

DIMENSIONS

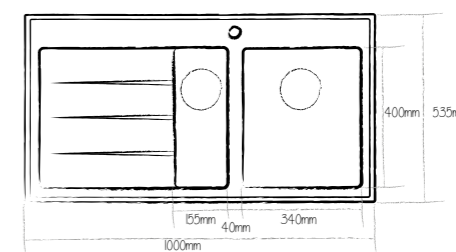

- Main bowl depth 200mm
- Small bowl depth 150mm
- Min. base unit 600mm
- Cut-out size 964 x 499mm

The glass drainer functions similarly to undermount sinks set directly into the work surface therefore small amounts of water may remain. This can simply be wiped away.

The glass drainer functions similarly to undermount sinks set directly into the work surface therefore small amounts of water may remain. This can simply be wiped away.

Stainless Steel Sinks

Stainless steel has been the automatic choice for professional cooks over many years. Why not make it yours? It is tough, resilient and highly practical – and in our range of styles and shapes it looks sensational too.



INSET SINKS



PERFECT FIT

Inset sinks are the only sink that can be neatly fitted into any surface type.

FAMILY BUSINESS

Sinks are grouped into families, making it easy to find the style and bowl combination to suit. Each set feature drainers, with a distinctive pattern for a unique look.

TO THE LEFT?

Do you need a drainer on the left or right side? With many of these sinks you have the flexibility to choose. For a conventional look, go with a single bowl with drainer. Or for something a little different, try a one and a half bowl.

LOW PROFILE

Low profile for a cleaner, sleeker fitting, our Blaze and Cubit sinks feature a low profile edge of only 1mm.



BELFAST SIT-ON



DIMENSIONS

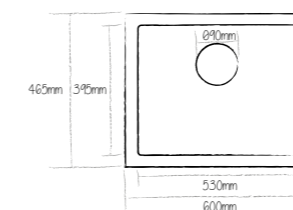

Bowl depth
229mm
Overall sink depth
254mm
Min. base unit
600mm

PRODUCT CODE
BELSS

FINISH AVAILABLE
Stainless steel

FEATURES

- 1.2mm brushed stainless steel
- 90mm waste outlet for a basket strainer waste
- Suitable for a waste disposer
- Waste and overflow included

PLUMBING OPTION

- Plumbing kit CPK100

ACCESSORY OPTIONS



Universal wooden chopping board
CBB3040



Chrome sink grid
CGRID7



Basket strainer waste decorative cover
CWC2

CUBIT INSET SINKS

Cubit sinks add minimalist design to the benefits of stainless steel sinks, to create a sink for those that love clean lines and no nonsense modern styling.



Sharp, crisp edges and an uncluttered design, coupled with a sleek, low profile edge of only 1mm, give the Cubit sinks an industrial quality that many modern designers like to use in today's cutting edge kitchens.

CUBIT 100 INSET WITH DRAINER



PRODUCT CODE
CU100/L - Left handed drainer
CU100/R - Right handed drainer

FINISH AVAILABLE
Stainless steel

FEATURES

- Bowl frame 1.2mm satin stainless steel
- Edge profile thickness 1mm
- Left or right handed drainer
- 1 Punched tap hole
- 90mm waste outlet for a basket strainer waste
- Suitable for a waste disposer
- Waste and overflow included

PLUMBING OPTION
- Plumbing kit CPK100

←→ DIMENSIONS

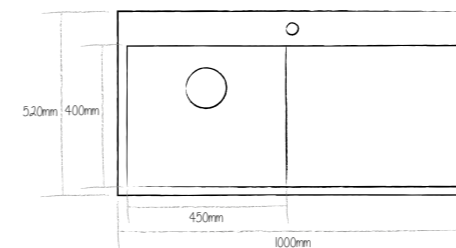

CUBIT 150 INSET WITH DRAINER



PRODUCT CODE
CU150/L - Left handed drainer
CU150/R - Right handed drainer

FINISH AVAILABLE
Stainless steel

FEATURES

- Bowl frame 1.2mm satin stainless steel
- Edge profile thickness 1mm
- Left or right handed drainer
- 1 Punched tap hole
- 2 90mm waste outlets for basket strainer wastes
- Suitable for a waste disposer
- Wastes, overflows and plumbing kit included

←→ DIMENSIONS

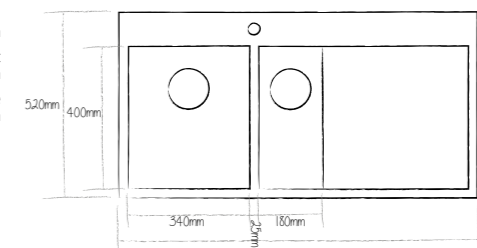

ACCESSORY OPTIONS



Basket strainer waste decorative cover CWC2

ACCESSORY OPTIONS



Basket strainer waste decorative cover CWC2

NADA INSET & UNDERMOUNT SINKS



Nada's clean lines and minimal design is ideal for the perfectionist in you. You can inset this sink to expose the excellently crafted zero radius corners or undermount it for the ultimate contemporary look.

Both Nada 100 and 150 are undeniably practical with a large draining area and they are also produced from premium stainless steel suitable for any busy household.

NADA 100 INSET & UNDERMOUNT



PRODUCT CODE
NA100/L Left handed drainer
NA100/R Right handed drainer

FINISH AVAILABLE
Stainless steel

- FEATURES**
- Bowl frame 1.2mm satin stainless steel
 - Edge profile thickness 1mm
 - Left or right handed drainer
 - 1 Punched tap hole
 - 90mm waste outlet for a basket strainer waste
 - Suitable for a waste disposer
 - Waste and overflow included
 - Decorative waste cover included [CWC2]

PLUMBING OPTION
- Plumbing kit CPK100

ACCESSORY OPTIONS



NADA 150 INSET & UNDERMOUNT



PRODUCT CODE
NA150/L Left handed drainer
NA150/R Right handed drainer

FINISH AVAILABLE
Stainless steel

- FEATURES**
- Bowl frame 1.2mm satin stainless steel
 - Edge profile thickness 1mm
 - Left or right handed drainer
 - 1 Punched tap hole
 - 2 90mm waste outlets for basket strainer wastes
 - Suitable for a waste disposer
 - Waste and overflow included
 - Decorative waste cover included [2 x CWC2]

PLUMBING OPTION
- Plumbing kit CPK100

ACCESSORY OPTIONS



DIMENSIONS

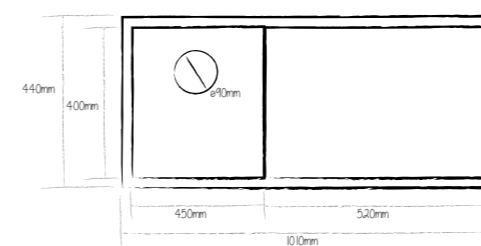

DIMENSIONS

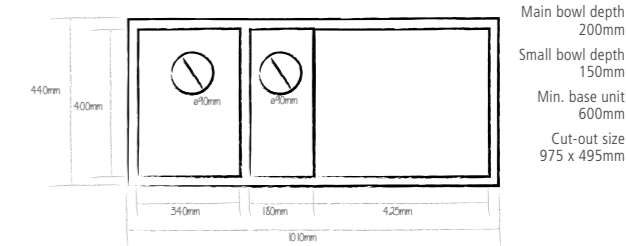

BLAZE 100 INSET WITH DRAINER



PRODUCT CODE
BZ100/L - Left handed drainer
BZ100/R - Right handed drainer

FINISH AVAILABLE
Stainless steel

- FEATURES**
- Bowl 0.8 mm frame 1mm satin stainless steel
 - 1mm low profile edge
 - Left or right handed drainer
 - 1 Punched tap hole
 - 90mm waste outlet for a basket strainer waste
 - Suitable for a waste disposer
 - Waste and overflow included

PLUMBING OPTION
- Plumbing kit CPK100

ACCESSORY OPTIONS



BLAZE 150 INSET WITH DRAINER



PRODUCT CODE
BZ150/L - Left handed drainer
BZ150/R - Right handed drainer

FINISH AVAILABLE
Stainless steel

- FEATURES**
- Bowl 0.8 mm frame 1mm satin stainless steel
 - 1mm low profile edge
 - Left or right handed drainer
 - 1 Punched tap hole
 - 2 90mm waste outlets for basket strainer wastes
 - Suitable for a waste disposer
 - Wastes, overflow and plumbing kit included

ACCESSORY OPTIONS



DOVE 100 INSET WITH DRAINER



PRODUCT CODE
DO100SS

FINISH AVAILABLE
Stainless steel

- FEATURES**
- 0.7mm satin stainless steel
 - Reversible
 - 2 Punched tap holes [one for tap hole stopper]
 - 90mm waste outlet for a basket strainer waste
 - Suitable for a waste disposer
 - Waste and overflow included

PLUMBING OPTION
- Plumbing kit CPK100

ACCESSORY OPTIONS

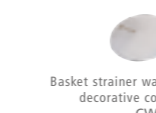

DOVE 150 INSET WITH DRAINER



PRODUCT CODE
DO150SS

FINISH AVAILABLE
Stainless steel

- FEATURES**
- 0.7mm satin stainless steel
 - Reversible
 - 2 Punched tap holes [one for tap hole stopper]
 - 2 90mm waste outlets for basket strainer wastes
 - Suitable for a waste disposer
 - Wastes, overflow and plumbing kit included

ACCESSORY OPTIONS

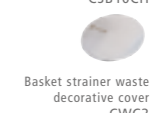

DIMENSIONS

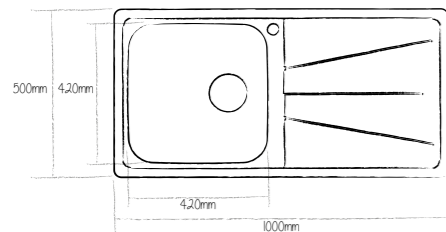

DIMENSIONS

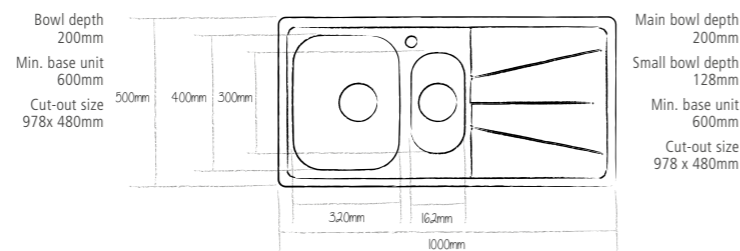

DIMENSIONS

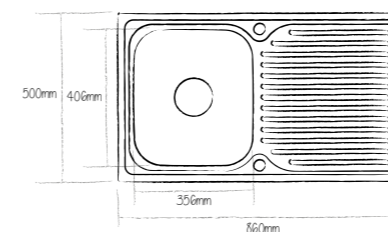

DIMENSIONS

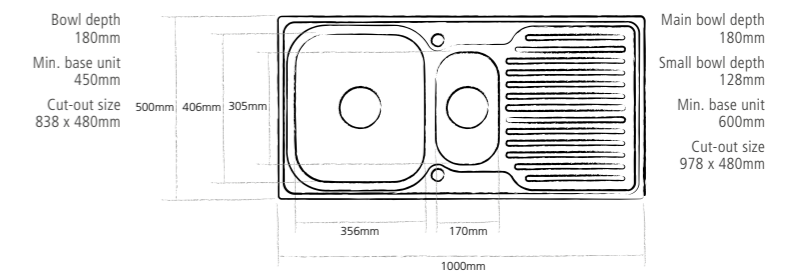

LYON INSET SINKS



MATCH MADE IN HEAVEN

Our glass chopping board [CGCB2] fits the Lyon [shown above] and Blaze perfectly, making it easy to rinse and chop.

LYON 100 INSET WITH DRAINER



PRODUCT CODE
LY100/L - Left handed drainer
LY100/R - Right handed drainer

FINISH AVAILABLE
Stainless steel

FEATURES

- Bowl 0.8 mm frame 0.9mm satin stainless steel
- Left or right handed drainer
- 1 Punched tap hole
- 90mm waste outlet for a basket strainer waste
- Suitable for a waste disposer
- Waste and overflow included

PLUMBING OPTION
- Plumbing kit CPK100

ACCESSORY OPTIONS

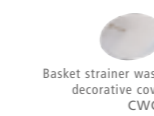

LYON 150 INSET WITH DRAINER



PRODUCT CODE
LY150/L - Left handed drainer
LY150/R - Right handed drainer

FINISH AVAILABLE
Stainless steel

FEATURES

- Bowl 0.8 mm frame 0.9mm satin stainless steel
- Left or right handed drainer
- 1 Punched tap hole
- 2 90mm waste outlets for basket strainer wastes
- Suitable for a waste disposer
- Waste, overflow and plumbing kit included

ACCESSORY OPTIONS



DIMENSIONS

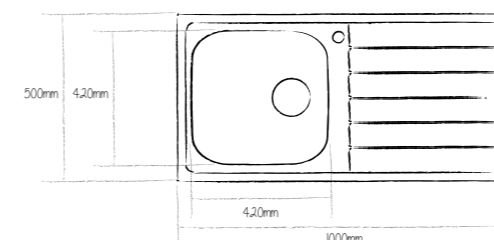

DIMENSIONS

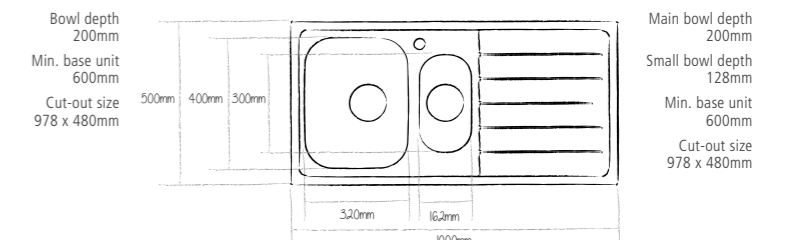

VANGA 90 INSET WITH DRAINER



PRODUCT CODE

- VA90/L - Left handed drainer
- VA90/R - Right handed drainer

FINISH AVAILABLE

- Stainless steel

FEATURES

- 0.8mm satin stainless steel
- Left or right handed drainer
- 1 Punched tap hole
- 90mm waste outlet for a basket strainer waste
- Suitable for a waste disposer
- Waste and overflow included

PLUMBING OPTION

- Plumbing kit CPK100

ACCESSORY OPTIONS



VANGA 100 INSET WITH DRAINER



PRODUCT CODE

- VA100/L - Left handed drainer
- VA100/R - Right handed drainer

FINISH AVAILABLE

- Stainless steel

FEATURES

- 0.8mm satin stainless steel
- Left or right handed drainer
- 1 Punched tap hole
- 90mm waste outlet for a basket strainer waste
- Suitable for a waste disposer
- Waste and overflow included

PLUMBING OPTION

- Plumbing kit CPK100

ACCESSORY OPTIONS



DIMENSIONS

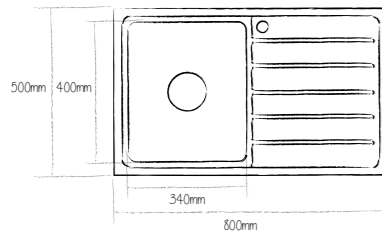

DIMENSIONS

- Main bowl depth 200mm
- Min. base unit 450mm
- Cut-out size 780 x 480mm

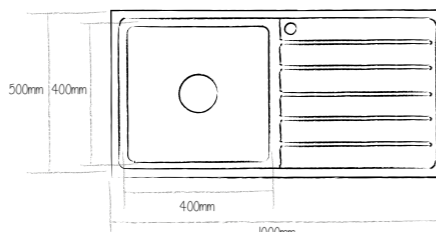

- Bowl depth 200mm
- Min. base unit 600mm
- Cut-out size 980 x 480mm



VANGA 150 INSET WITH DRAINER



PRODUCT CODE

- VA150/L - Left handed drainer
- VA150/R - Right handed drainer

FINISH AVAILABLE

- Stainless steel

FEATURES

- 0.8mm satin stainless steel
- Left or right handed drainer
- 1 Punched tap hole
- 2 90mm waste outlets for basket strainer wastes
- Suitable for a waste disposer
- Wastes, overflow and plumbing kit included

DIMENSIONS

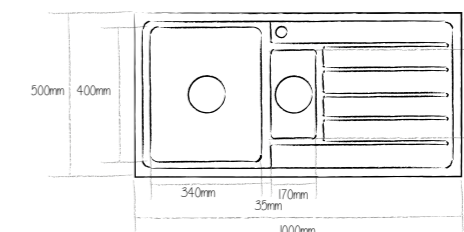

ACCESSORY OPTIONS



- Main bowl depth 200mm
- Small bowl depth 175mm
- Min. base unit 600mm
- Cut-out size 980 x 480mm

Features

ROWECA ANTHRACITE CHOPPING BOARD

- Made from Eco friendly paper
- Dishwasher friendly
- Heat resistant up to 176°C
- Food safe & hygienic
- Highly durable





CRANE 91 INSET WITH DRAINER



PRODUCT CODE
CR91SS

FINISH AVAILABLE
Stainless steel

FEATURES

- 0.5mm satin stainless steel
- Reversible
- 2 Punched tap holes [one for tap hole stopper]
- 90mm waste outlet for a basket strainer waste
- Suitable for a waste disposer
- Waste and overflow included

PLUMBING OPTION

- Plumbing kit CPK100

ACCESSORY OPTIONS



Universal wooden chopping board CCB2



Chrome main bowl basket CMBB31CH



Basket strainer waste decorative cover CWC2

CRANE 101 INSET WITH DRAINER



PRODUCT CODE
CR101SS

FINISH AVAILABLE
Stainless steel

FEATURES

- 0.5mm satin stainless steel
- Reversible
- 2 Punched tap holes [one for tap hole stopper]
- 90mm waste outlet for a basket strainer waste
- Suitable for a waste disposer
- Waste and overflow included

PLUMBING OPTION

- Plumbing kit CPK100

ACCESSORY OPTIONS



Universal wooden chopping board CCB2



Basket strainer waste decorative cover CWC2

CRANE 151 INSET WITH DRAINER



PRODUCT CODE
CR151SS

FINISH AVAILABLE
Stainless steel

FEATURES

- 0.5mm satin stainless steel
- Reversible
- 2 Punched tap holes [one for tap hole stopper]
- 2 90mm waste outlets for basket strainer wastes
- Suitable for a waste disposer
- Wastes and overflow included

PLUMBING OPTION

- Plumbing kit CPK200

ACCESSORY OPTIONS



Universal wooden chopping board CCB2



Chrome main bowl basket CMBB31CH



Chrome small bowl basket CSB10CH



Basket strainer waste decorative cover CWC2

DIMENSIONS

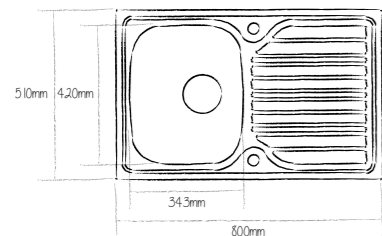

DIMENSIONS

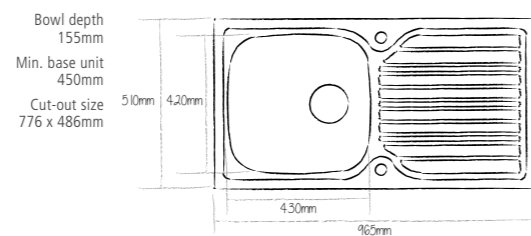

Main bowl depth 155mm
Min. base unit 600mm
Cut-out size 941 x 486mm

DIMENSIONS

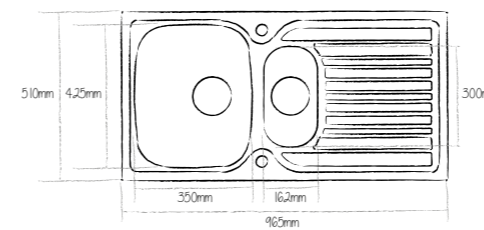

Main bowl depth 155mm
Small bowl depth 90mm
Min. base unit 600mm
Cut-out size 941 x 486mm

AXLE INSET AND UNDERMOUNTED SINKS

Introducing Caple's new range of inset and undermounted stainless steel sinks. With a choice of 3 sizes, each sink includes a steel colander and a wooden chopping board, both of which are specially designed to fit the bowl perfectly. Each accessory sits side-by-side on a small ledge making it quick and easy to chop, drain and rinse freely.



Axle sinks are ideal for apartment living, freeing up valuable worktop areas when space-saving is key.



AXLE 45 INSET OR UNDERMOUNT



PRODUCT CODE
AXL45

FINISH AVAILABLE
 Stainless steel

FEATURES

- 1.0mm stainless steel
- Single bowl
- No tap facility
- 90mm waste kit, overflow and plumbing kit included
- Colander and chopping board for bowl ledge included
- Suitable for a waste disposer

ACCESSORY INCLUDED



Stainless steel colander and beech chopping board

AXLE 50 INSET OR UNDERMOUNTED



PRODUCT CODE
AXL50

FINISH AVAILABLE
 Stainless steel

FEATURES

- 1.0mm stainless steel
- Single bowl
- No tap facility
- 90mm waste kit, overflow and plumbing kit included
- Colander and chopping board for bowl ledge included
- Suitable for a waste disposer

ACCESSORY INCLUDED



Stainless steel colander and beech chopping board

AXLE 175 INSET



PRODUCT CODE
AXL175

FINISH AVAILABLE
 Stainless steel

FEATURES

- 1.0mm stainless steel
- 1.75 bowl
- 1 tap hole
- 90mm waste kit, overflow and plumbing kit included
- Colander and chopping board for bowl ledge included
- Suitable for a waste disposer

ACCESSORY INCLUDED



Stainless steel colander and beech chopping board

Features



Stainless steel colander



Beech chopping board



Stainless steel colander and beech chopping board

ACCESSORIES

Each sink includes a steel colander and a wooden chopping board designed to fit the bowl perfectly.

DIMENSIONS

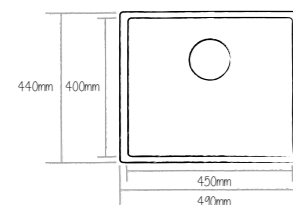

Bowl depth 200mm
 Min. base unit 600mm
 Inset Cut-out size 420 x 470mm
 Undermount Cut-out size 405 x 455mm

DIMENSIONS

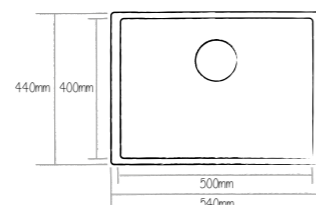

Bowl depth 200mm
 Min. base unit 600mm
 Inset Cut-out size 420 x 520mm
 Undermount Cut-out size 405 x 505mm

DIMENSIONS

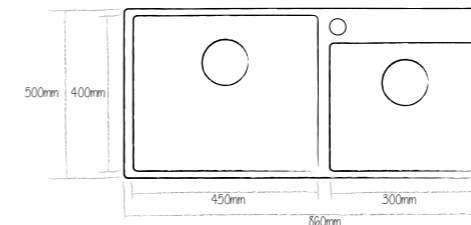

Main bowl depth 220mm
 Small bowl depth 185mm
 Min. base unit 600mm
 Inset Cut-out size 480 x 840mm
 Min. base unit 900mm

ZERO INDIVIDUAL AND MULTIPLE BOWLS

For the razor-sharp, minimalist look adopted by designer kitchen aficionados, nothing is better than Zero. These bowls feature crisp edges and clean lines in an uncluttered design.



LOOKING SHARP

The clean lines and minimalist styling of our Zero sinks suit modern kitchens to a tee.

Featuring a unique angular bowl with a 'zero' degree radius and tapered base, they'll take your designer kitchen to a new level.

PERFECT FIT

The striking geometric bowls come in many sizes, for countless creative possibilities. With multiple bowls and a sleek shallow drainer also available you can let your imagination run riot. Made from stainless steel, they won't rust,

stain, fade or crack, remaining pristine whatever you put them through.

Zero sinks can be inset or undermounted allowing you to combine them beautifully with any worktop.

ZERO 45 DRAINER INSET OR UNDERMOUNTED



PRODUCT CODE
ZEROD45

FINISH AVAILABLE
Stainless steel

FEATURES

- 1mm brushed stainless steel
- No tap facility
- 90mm waste outlet for a basket strainer waste
- Suitable for a waste disposer
- Waste included

PLUMBING OPTION
- Plumbing kit CPK100

FITTING OPTIONS

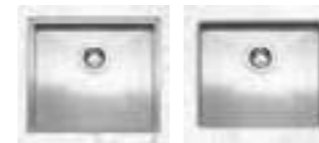

Inset Undermounted

For something a little left of centre, team a Zero bowl with a matching drainer, adding a unique touch to your kitchen. If you're really out to impress why not try a combination of two Zero sinks and a matching drainer.

DIMENSIONS

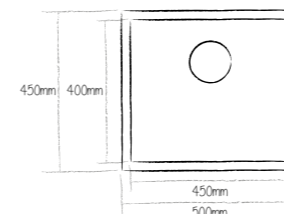

Drainer depth 25mm
Min. base unit 500mm
Cut-out size 450 x 400mm
For cut-out shape go to www.caple.co.uk for template

ZERO 20 INSET OR UNDERMOUNTED



PRODUCT CODE
ZERO20

FINISH AVAILABLE
Stainless steel

FEATURES

- 1mm brushed stainless steel
- No tap facility
- 90mm waste outlet for a basket strainer waste
- Suitable for a waste disposer
- Waste and overflow included

PLUMBING OPTION
- Plumbing kit CPK100

FITTING OPTIONS



Inset Undermounted

DIMENSIONS

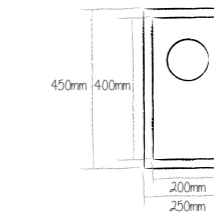

Bowl depth 140mm
Min. base unit 300mm
Cut-out size 200 x 400mm
For cut-out shape go to www.caple.co.uk for template

ACCESSORY OPTIONS



Basket strainer waste decorative cover CWC2

ACCESSORY OPTIONS



Roweca anthracite chopping board VACB



Stainless steel strainer bowl CSB2955



Basket strainer waste decorative cover CWC2

ZERO 35 INSET OR UNDERMOUNTED



PRODUCT CODE
ZERO35

FINISH AVAILABLE

Stainless steel

FEATURES

- 1mm brushed stainless steel
- No tap facility
- 90mm waste outlet for a basket strainer waste
- Suitable for a waste disposer
- Waste and overflow included

PLUMBING OPTION

- Plumbing kit CPK100

FITTING OPTIONS

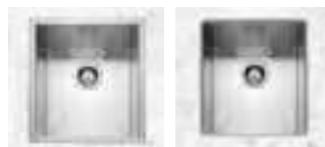

Inset Undermounted

⇔ DIMENSIONS

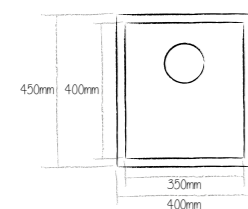

ZERO 45 INSET OR UNDERMOUNTED



PRODUCT CODE
ZERO45

FINISH AVAILABLE

Stainless steel

FEATURES

- 1mm brushed stainless steel
- No tap facility
- 90mm waste outlet for a basket strainer waste
- Suitable for a waste disposer
- Waste and overflow included

PLUMBING OPTION

- Plumbing kit CPK100

FITTING OPTIONS

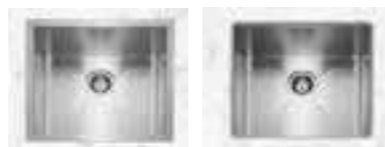

Inset Undermounted

⇔ DIMENSIONS

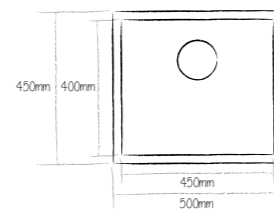

Bowl depth
200mm
Min. base unit
500mm
Cut-out size
450 x 400mm
For cut-out shape go to
www.caple.co.uk for template

ZERO 55 INSET OR UNDERMOUNTED



PRODUCT CODE
ZERO55

FINISH AVAILABLE

Stainless steel

FEATURES

- 1mm brushed stainless steel
- No tap facility
- 90mm waste outlet for a basket strainer waste
- Suitable for a waste disposer
- Waste and overflow included

PLUMBING OPTION

- Plumbing kit CPK100

FITTING OPTIONS

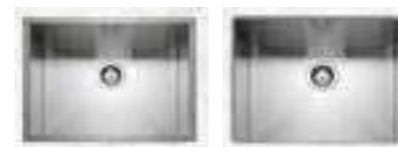

Inset Undermounted

⇔ DIMENSIONS

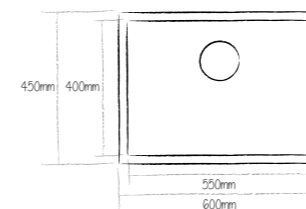

Bowl depth
200mm
Min. base unit
600mm
Cut-out size
550 x 400mm
For cut-out shape go to
www.caple.co.uk for template

ZERO 150 INSET OR UNDERMOUNTED



PRODUCT CODE
ZERO150R - Right handed small bowl
ZERO150L - Left handed small bowl

FINISH AVAILABLE

Stainless steel

FEATURES

- 1mm brushed stainless steel
- Left or right handed small bowl
- No tap facility
- 2 90mm waste outlets for basket strainer wastes
- Suitable for a waste disposer
- Wastes, overflows and plumbing kit included

FITTING OPTIONS

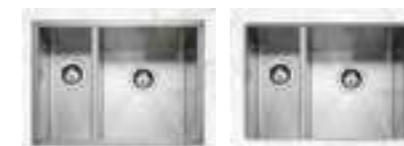

Inset Undermounted

⇔ DIMENSIONS

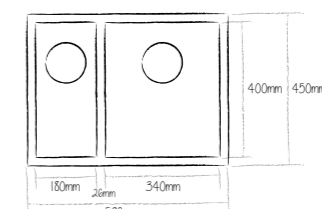

Main bowl depth
200mm
Small bowl depth
140mm
Min. base unit
600mm
Cut-out size
546 x 400mm
For cut-out shape go to
www.caple.co.uk for template

ACCESSORY OPTIONS



Roweca anthracite chopping board VACB



Chrome sink grid CGRID6



Stainless steel strainer bowl CSB2955



Basket strainer waste decorative cover CWC2

ACCESSORY OPTIONS



Roweca anthracite chopping board VACB



Chrome basket CMBB11CH



Stainless steel strainer bowl CSB2955



Basket strainer waste decorative cover CWC2

ACCESSORY OPTIONS



Roweca anthracite chopping board VACR



Stainless steel strainer bowl CSB2955



Basket strainer waste decorative cover CWC2

ACCESSORY OPTIONS



Roweca anthracite chopping board VACB



Chrome sink grid CGRID6



Stainless steel strainer bowl CSB2955



Basket strainer waste decorative cover CWC2

MODE INDIVIDUAL AND MULTIPLE BOWLS

Chic, modern and sophisticated sums up our Mode collection. These smart stainless steel bowls provide a wide variety of options that will finish off your modern kitchen – beautifully.



With so many options to choose from, including single and double bowls and a matching drainer, you'll find just the right combination for your kitchen. To achieve a contemporary aesthetic pair two bowls of your choice.

MODERN MODE

Mode's distinctive look combines ultra modern straight edges and subtly curved corners. The result? A contemporary sink with a touch of class.

TRULY VERSATILE

Whether you prefer an inset or undermounted look, Mode sinks are flexible enough to accommodate any worktop and tap of your choice.

MODE 45 DRAINER INSET OR UNDERMOUNTED



PRODUCT CODE
MODED045

FINISH AVAILABLE
 Stainless steel

- FEATURES
- 1mm brushed stainless steel
 - No tap facility
 - 90mm waste outlet for a basket strainer waste
 - Suitable for a waste disposer
 - Waste included

PLUMBING OPTION
- Plumbing kit CPK100

FITTING OPTIONS

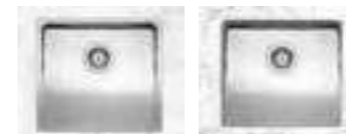

Inset Undermounted

The Mode drainer is an elegant accompaniment to our range of Mode individual bowls. Featuring a shallow base, it offers the full practicality of a drainer whilst maintaining a sleek minimalist design.

↔ DIMENSIONS

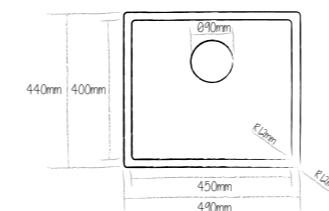

MODE 25 INSET OR UNDERMOUNTED



PRODUCT CODE
MODE025

FINISH AVAILABLE
 Stainless steel

- FEATURES
- 1mm brushed stainless steel
 - No tap facility
 - 90mm waste outlet for a basket strainer waste
 - Suitable for a waste disposer
 - Waste and overflow included

PLUMBING OPTION
- Plumbing kit CPK100

FITTING OPTIONS



Inset Undermounted

The Mode bowl is an elegant accompaniment to our range of Mode individual bowls. Featuring a shallow base, it offers the full practicality of a bowl whilst maintaining a sleek minimalist design.

↔ DIMENSIONS

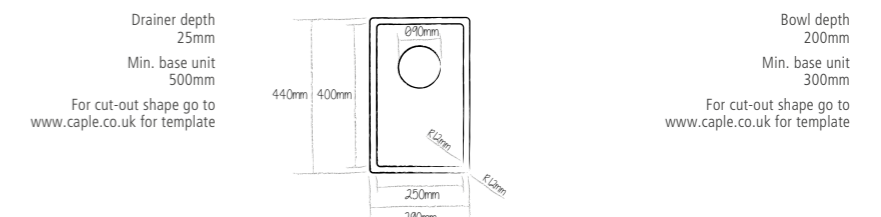

ACCESSORY OPTIONS



ACCESSORY OPTIONS



MODE 34
INSET OR UNDERMOUNTED



PRODUCT CODE
MODE034

FINISH AVAILABLE
 Stainless steel

- FEATURES**
- 1mm brushed stainless steel
 - No tap facility
 - 90mm waste outlet for a basket strainer waste
 - Suitable for a waste disposer
 - Waste and overflow included

PLUMBING OPTION
- Plumbing kit CPK100

FITTING OPTIONS

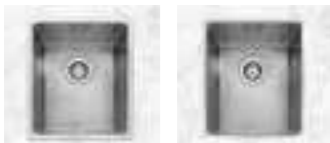

Inset Undermounted

DIMENSIONS

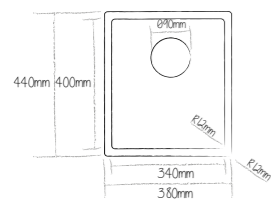

MODE 40
INSET OR UNDERMOUNTED



PRODUCT CODE
MODE040

FINISH AVAILABLE
 Stainless steel

- FEATURES**
- 1mm brushed stainless steel
 - No tap facility
 - 90mm waste outlet for a basket strainer waste
 - Suitable for a waste disposer
 - Waste and overflow included

PLUMBING OPTION
- Plumbing kit CPK100

FITTING OPTIONS

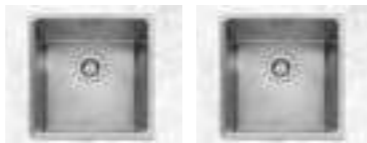

Inset Undermounted

DIMENSIONS

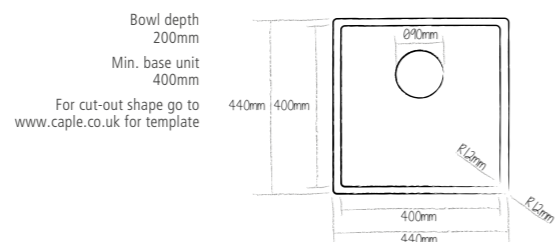

MODE 45
INSET OR UNDERMOUNTED



PRODUCT CODE
MODE045

FINISH AVAILABLE
 Stainless steel

- FEATURES**
- 1mm brushed stainless steel
 - No tap facility
 - 90mm waste outlet for a basket strainer waste
 - Suitable for a waste disposer
 - Waste and overflow included

PLUMBING OPTION
- Plumbing kit CPK100

FITTING OPTIONS

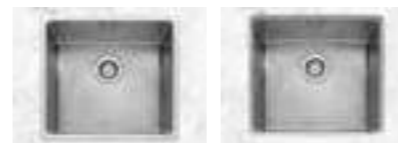

Inset Undermounted

DIMENSIONS

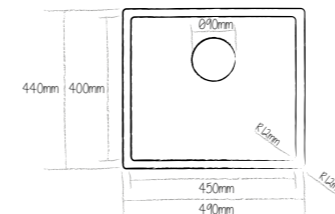

MODE 50
INSET OR UNDERMOUNTED



PRODUCT CODE
MODE050

FINISH AVAILABLE
 Stainless steel

- FEATURES**
- 1mm brushed stainless steel
 - No tap facility
 - 90mm waste outlet for a basket strainer waste
 - Suitable for a waste disposer
 - Waste and overflow included

PLUMBING OPTION
- Plumbing kit CPK100

FITTING OPTIONS



Inset Undermounted

DIMENSIONS

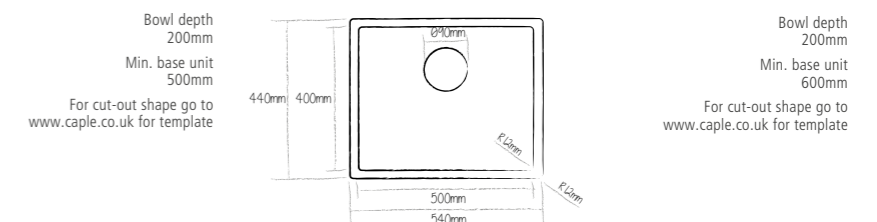

ACCESSORY OPTIONS



Roweca anthracite chopping board VACB



Chrome sink grid CGRID6



Stainless steel strainer bowl CSB2955



Basket strainer waste decorative cover CWC2

ACCESSORY OPTIONS



Roweca anthracite chopping board VACB



Chrome sink basket CMBB19CH



Stainless steel strainer bowl CSB2955



Basket strainer waste decorative cover CWC2

ACCESSORY OPTIONS



Roweca anthracite chopping board VACB



Chrome sink grid CMBB11CH



Stainless steel strainer bowl CSB2955



Basket strainer waste decorative cover CWC2

ACCESSORY OPTIONS



Roweca anthracite chopping board VACB



Stainless steel strainer bowl CSB2955



Basket strainer waste decorative cover CWC2

**MODE 45
INSET OR UNDERMOUNTED**



PRODUCT CODE
MODE045/CO

FINISH AVAILABLE
Copper

- FEATURES**
- 1.2mm brushed stainless steel
 - No tap facility
 - 90mm waste outlet for a basket strainer waste
 - Suitable for a waste disposer
 - Waste and overflow included

PLUMBING OPTION
- Plumbing kit CPK100

FITTING OPTIONS



Inset Undermounted

DIMENSIONS

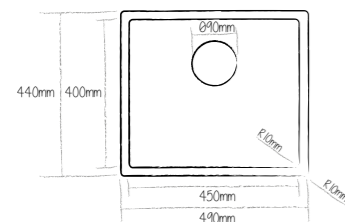

Bowl depth 200mm
Min. base unit 500mm
For cut-out shape go to www.caple.co.uk for template

**MODE 45
INSET OR UNDERMOUNTED**



PRODUCT CODE
MODE045/GM

FINISH AVAILABLE
Gunmetal

- FEATURES**
- 1.2mm brushed stainless steel
 - No tap facility
 - 90mm waste outlet for a basket strainer waste
 - Suitable for a waste disposer
 - Waste and overflow included

PLUMBING OPTION
- Plumbing kit CPK100

FITTING OPTIONS

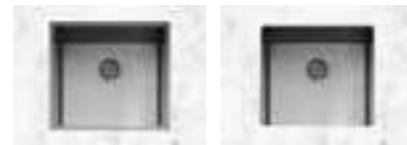

Inset Undermounted

DIMENSIONS

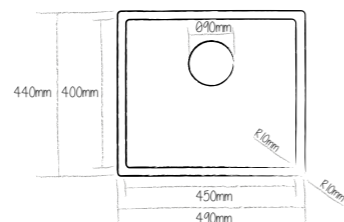

Bowl depth 200mm
Min. base unit 500mm
For cut-out shape go to www.caple.co.uk for template

**MODE 150
INSET OR UNDERMOUNTED**



PRODUCT CODE
MODE150/R - Right handed small bowl
MODE150/L - Left handed small bowl

FINISH AVAILABLE
Stainless steel

- FEATURES**
- 1mm brushed stainless steel
 - Left or right handed small bowl
 - No tap facility
 - 2 90mm waste outlets for basket strainer wastes
 - Suitable for a waste disposer
 - Wastes, overflows and plumbing kit included

FITTING OPTIONS

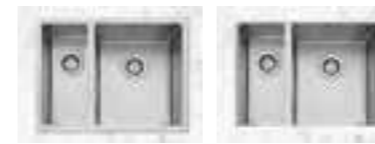

Inset Undermounted

DIMENSIONS

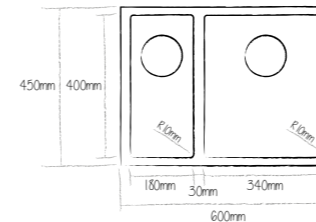

Main bowl depth 200mm
Small bowl depth 140mm
Min. base unit 600mm
For cut-out shape go to www.caple.co.uk for template

**MODE 3415
INSET OR UNDERMOUNTED**



PRODUCT CODE
MODE3415/R - Right handed small bowl
MODE3415/L - Left handed small bowl

FINISH AVAILABLE
Stainless steel

- FEATURES**
- 1mm brushed stainless steel
 - Left or right handed small bowl
 - No tap facility
 - 2 90mm waste outlets for basket strainer wastes
 - Suitable for a waste disposer
 - Wastes, overflows and plumbing kit included

FITTING OPTIONS



Inset Undermounted

DIMENSIONS

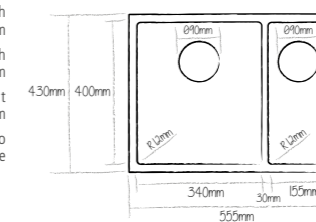

Main bowl depth 200mm
Small bowl depth 150mm
Min. base unit 600mm
For cut-out shape go to www.caple.co.uk for template

ACCESSORY OPTIONS



Copper colander MODECOL/CO

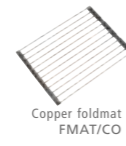

Copper foldmat FMAT/CO

ACCESSORY OPTIONS



Gunmetal colander MODECOL/GM



Gunmetal foldmat FMAT/GM

ACCESSORY OPTIONS



Roweca anthracite chopping board VACB



Chrome sink grid CGRID6



Stainless steel strainer bowl CSB2955



Basket strainer waste decorative cover CWC2

ACCESSORY OPTIONS



Roweca anthracite chopping board VACB



Chrome sink grid CGRID6



Stainless steel strainer bowl CSB2955



Basket strainer waste decorative cover CWC2



MODE 3415
INSET OR UNDERMOUNTED



PRODUCT CODE
MODE3415/R/CO - Right handed small bowl

FINISH AVAILABLE
 Copper

- FEATURES**
- 1.2mm brushed stainless steel
 - Right handed small bowl
 - No tap facility
 - 2 90mm waste outlets for basket strainer wastes
 - Suitable for a waste disposer
 - Wastes and overflows included

PLUMBING OPTION
- Plumbing kit CPK200

FITTING OPTIONS



Inset Undermounted

DIMENSIONS

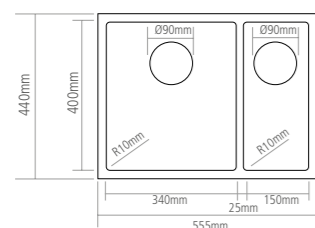

Main bowl depth 200mm
Small bowl depth 135mm
Min. base unit 600mm
For cut-out shape go to www.caple.co.uk for template

MODE 3415
INSET OR UNDERMOUNTED



PRODUCT CODE
MODE3415/R/GM - Right handed small bowl

FINISH AVAILABLE
 Gunmetal

- FEATURES**
- 1.2mm brushed stainless steel
 - Right handed small bowl
 - No tap facility
 - 2 90mm waste outlets for basket strainer wastes
 - Suitable for a waste disposer
 - Wastes and overflows included

PLUMBING OPTION
- Plumbing kit CPK200

FITTING OPTIONS

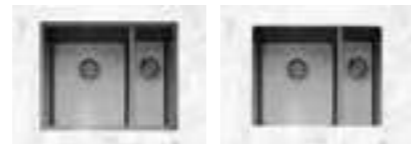

Inset Undermounted

DIMENSIONS

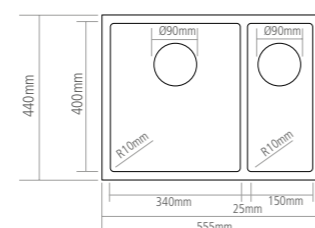

Main bowl depth 200mm
Small bowl depth 135mm
Min. base unit 600mm
For cut-out shape go to www.caple.co.uk for template

MODE 3434
INSET OR UNDERMOUNTED



PRODUCT CODE
MODE3434

FINISH AVAILABLE
 Stainless steel

- FEATURES**
- 1mm brushed stainless steel
 - No tap facility
 - 2 90mm waste outlets for basket strainer wastes
 - Suitable for a waste disposer
 - Wastes, overflows and plumbing kit included

FITTING OPTIONS



Inset Undermounted

DIMENSIONS

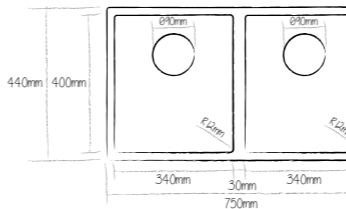

Bowl depth 200mm
Min. base unit 800mm
For cut-out shape go to www.caple.co.uk for template

ACCESSORY OPTIONS



Copper colander
MODECOL/CO



Copper foldmat
FMAT/CO

ACCESSORY OPTIONS



Gunmetal colander
MODECOL/GM



Gunmetal foldmat
FMAT/GM

ACCESSORY OPTIONS



Roweca anthracite
chopping board
VACB



Chrome sink grid
CGRID6



Stainless steel
strainer bowl
CSB2955



Basket strainer waste
decorative cover
CWC2

FORM INDIVIDUAL AND MULTIPLE BOWLS

With it's rounded design the Form collection combines the advantages of stainless steel with traditional styling.



FORM 17 UNDERMOUNTED



PRODUCT CODE
FORM17

FINISH AVAILABLE
 Stainless steel

- FEATURES
- 0.8mm satin stainless steel
 - No tap facility
 - 90mm waste outlet for a basket strainer waste
 - Suitable for a waste disposer
 - Waste and overflow included

PLUMBING OPTION
 - Plumbing kit CPK100

ACCESSORY OPTIONS



FORM 33 UNDERMOUNTED



PRODUCT CODE
FORM33

FINISH AVAILABLE
 Stainless steel

- FEATURES
- 1.0mm satin stainless steel
 - No tap facility
 - 90mm waste outlet for a basket strainer waste
 - Suitable for a waste disposer
 - Waste and overflow included

PLUMBING OPTION
 - Plumbing kit CPK100

ACCESSORY OPTIONS



The charming, individual bowls come in a selection of shapes and sizes. Or if you want a more personalised combination of sinks you can choose from our multiple bowl options.

You have the choice of an undermounted sink for use with wooden, granite or solid surface worktops, or one of our inset models that can be used with laminate surfaces.

Crafted from stainless steel, Form sinks will keep their shiny good looks whatever you throw at them. Practical, stylish and functional, this collection meets the most demanding kitchen criteria.



OPTIONS TO SUIT YOU

Do you like the clean look of individual bowls but also need a drainer? Our round inset drainer option could be the answer. For a modern twist on the traditional country cottage style, pair this drainer with a single round bowl dropped into a solid wood worktop.

←→ DIMENSIONS

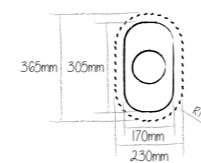

Bowl depth
140mm
Min. base unit
300mm
For cut-out shape go to
www.caple.co.uk for template

←→ DIMENSIONS

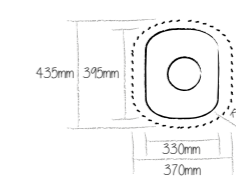

Main bowl depth
180mm
Min. base unit
400mm
For cut-out shape go to
www.caple.co.uk for template

**FORM 42
UNDERMOUNTED**



PRODUCT CODE
FORM42

FINISH AVAILABLE
Stainless steel

- FEATURES
- 1.0mm satin stainless steel
 - No tap facility
 - 90mm waste outlet for a basket strainer waste
 - Suitable for a waste disposer
 - Waste and overflow included

PLUMBING OPTION
- Plumbing kit CPK100

**FORM 52
UNDERMOUNTED**



PRODUCT CODE
FORM52

FINISH AVAILABLE
Stainless steel

- FEATURES
- 1.0mm satin stainless steel
 - No tap facility
 - 90mm waste outlet for a basket strainer waste
 - Suitable for a waste disposer
 - Waste and overflow included

PLUMBING OPTION
- Plumbing kit CPK100

**FORM 150
UNDERMOUNTED**



RIGHT HANDED SMALL BOWL

PRODUCT CODE
FORM150R - Right handed small bowl
FORM150L - Left handed small bowl

FINISH AVAILABLE
Stainless steel

- FEATURES
- 1.0mm satin stainless steel
 - Left or right handed small bowl
 - No tap facility
 - 2 90mm waste outlets for basket strainer wastes
 - Suitable for a waste disposer
 - Wastes, overflows and plumbing kit included

CONFIGURATION OPTION



Left handed small bowl

**FORM 150
UNDERMOUNTED**



PRODUCT CODE
FORM150UNI

FINISH AVAILABLE
Stainless steel

- FEATURES
- 1.0mm satin stainless steel
 - No tap facility
 - 2 90mm waste outlets for basket strainer wastes
 - Suitable for a waste disposer
 - Wastes, overflow and plumbing kit included

ACCESSORY OPTIONS



Universal wooden chopping board CCB2



Chrome basket CMBB1CH



Basket strainer waste decorative cover CWC2

ACCESSORY OPTIONS



Universal wooden chopping board CCB2



Basket strainer waste decorative cover CWC2

ACCESSORY OPTIONS



Universal wooden chopping board CCB2



Chrome main bowl basket CMBB13CH



Stainless steel small bowl basket CSB2SS



Basket strainer waste decorative cover CWC2

ACCESSORY OPTIONS



Universal wooden chopping board CCB2



Chrome main bowl basket CMBB13CH



Stainless steel small bowl basket CSB2SS



Basket strainer waste decorative cover CWC2

↔ DIMENSIONS

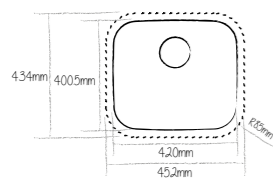

↔ DIMENSIONS

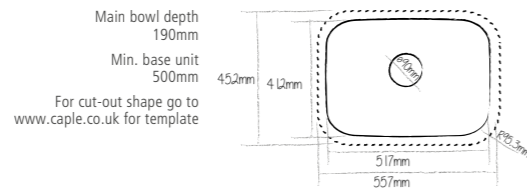

Bowl depth 230mm
Min. base unit 600mm
For cut-out shape go to www.caple.co.uk for template

↔ DIMENSIONS

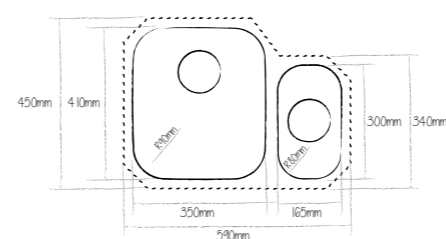

Main bowl depth 180mm
Small bowl depth 125mm
Min. base unit 600mm
For cut-out shape go to www.caple.co.uk for template

↔ DIMENSIONS

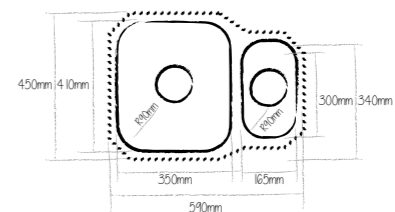

Main bowl depth 180mm
Small bowl depth 125mm
Min. base unit 600mm
For cut-out shape go to www.caple.co.uk for template

**FORM 3636
UNDERMOUNTED**



PRODUCT CODE
FORM3636

FINISH AVAILABLE
 Stainless steel

- FEATURES**
- 1.0mm satin stainless steel
 - No tap facility
 - 2 90mm waste outlets for basket strainer wastes
 - Suitable for a waste disposer
 - Wastes, overflows and plumbing kit included

ACCESSORY
OPTIONS



**FORM 45
INSET OR UNDERMOUNTED**



PRODUCT CODE
BI45

FINISH AVAILABLE
 Stainless steel

- FEATURES**
- 0.8mm satin stainless steel
 - No tap facility
 - 90mm waste outlet for a basket strainer waste
 - Suitable for a waste disposer
 - Waste and overflow included

- PLUMBING OPTIONS**
- Plumbing kit CPK100
 - Plumbing kit CPK200 if combined with BI45

ACCESSORY
OPTIONS



**FORM 45
INSET OR UNDERMOUNTED DRAINER**



PRODUCT CODE
DI45

FINISH AVAILABLE
 Stainless steel

- FEATURES**
- 1mm satin stainless steel
 - 90mm waste outlet for a basket strainer waste

- PLUMBING OPTIONS**
- Plumbing kit CPK100
 - Plumbing kit CPK200if combined with BI45

ACCESSORY
OPTIONS



Designed to accompany the round inset Form 45 bowl the handy inset Form drainer is a great way to add interest to your sink design. The sink and matching drainer combined create a perfectly symmetrical, truly classic look.

↔ DIMENSIONS

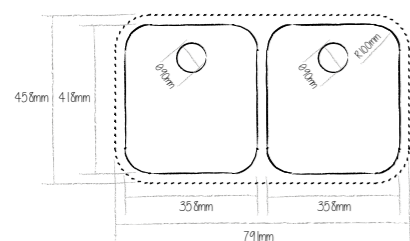

Bowl depths
210mm
Min. base unit
900mm
For cut-out shape go to
www.caple.co.uk for template

↔ DIMENSIONS

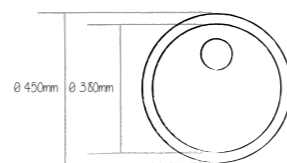

Bowl depth
180mm
Min. base unit
500mm
Cut out size
ø430mm

↔ DIMENSIONS

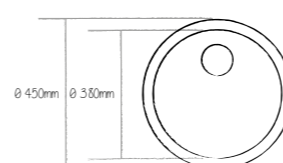

Drainer depth
40mm
Min. base unit
500mm
Cut out size
ø430mm

PLUMBING KITS, WASTES, FITTINGS, AND ACCESSORIES

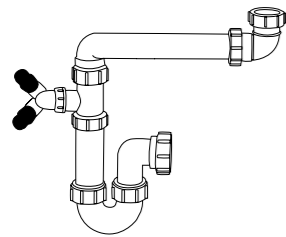

1 BOWL PLUMBING KIT
CPK100

- Provision for washing machines and dishwashers
- Water seal P trap

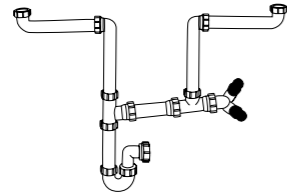

2 BOWL PLUMBING KIT
CPK200

- Provision for washing machines and dishwashers
- Water seal P trap

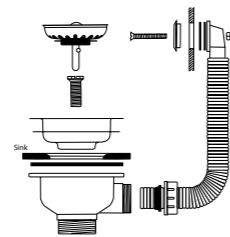

SQUARE OVERFLOW WASTE KIT
CPK1501

- Stainless steel
- 90mm basket strainer waste
- Square overflow

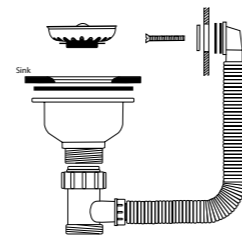

SQUARE OVERFLOW WASTE KIT
CPK1900 - Chrome
CPK2500 - Brushed steel

- 90mm basket strainer waste
- Square overflow

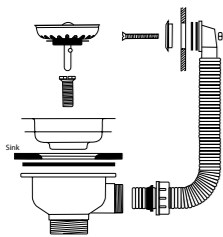

ROUND OVERFLOW WASTE KIT
CPK501

- Stainless steel
- 90mm basket strainer waste
- Round overflow

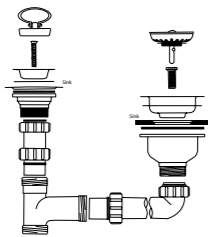

WASTE AND BOWL CONNECTION KIT
CPK400

- Stainless steel
- 90mm basket strainer waste and 60mm waste and plug
- No overflow

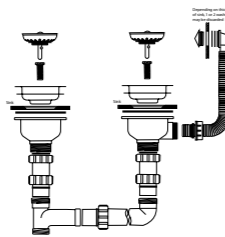

WASTE AND BOWL CONNECTION KIT
CPK801

- Stainless steel
- 2 x 90mm basket strainer wastes
- Round overflow

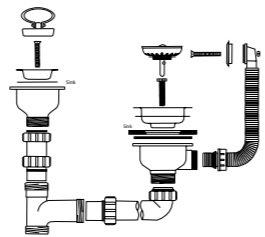

WASTE AND BOWL CONNECTION KIT
CPK1101

- Stainless steel
- 90mm basket strainer waste and 60mm waste and plug
- Round overflow



WASTE AND BOWL CONNECTION KIT
CPK2701

- Stainless steel
- 90mm basket strainer waste
- Round overflow



90MM STAINLESS STEEL BASKET STRAINER WASTE
BSW/OF/SS3

- Supplied with overflow connection and blanking plug
- Basket strainer waste can be purchased without connection and blanking plug [BSW]



90MM BASKET STRAINER WASTE
BSW/CH3 - Chrome
BSW/BS - Brushed Steel

- No overflow
- Max sink thickness 20mm



65MM STAINLESS STEEL WASTE
CAP/PW/SS3

- Waste and plug
- For Belfast sinks with 65mm waste outlet



65MM SLOTTED WASTE
CAP/SL/CH

- For Belfast sinks with 65mm waste outlet
- Supplied with chrome plug, chain and screwed stay
- For sinks up to 80mm thickness



OVERFLOW KIT
CPOF500 - Chrome
CPOF600 - Stainless steel

- Pair CPOF500 with chrome basket strainer waste [BSW/CH3]
- Pair CPOF600 with stainless steel basket strainer waste [BSW/OF/SS3 or BSW/BS]



OVERFLOW KIT
CPOF7

- Both round and rectangular backplate connections
- Round chrome plated grill only
- Flexible tube and bolt



SOAP DISPENSER
CSD/CH

- Push down operation
- Chrome dispenser
- Height above work surface 55mm
- 350ml capacity
- Reach 100mm
- Bottle height 200mm
- Work surface cut-out of 28mm is required



SOAP DISPENSER
CSD2/SS

- Push down operation
- Stainless steel dispenser
- Height above work surface 63mm
- 360ml capacity
- Reach 85mm
- Bottle height 155mm
- Work surface cut-out of 25mm is required



WASTE COVER
CWC2

- Basket strainer waste decorative cover



UNIVERSAL WOODEN CHOPPING BOARD
CBB3040

- Beech
- 400 x 300mm



UNIVERSAL WOODEN CHOPPING BOARD
CCB2

- Beech
- 440 x 328mm



GLASS CHOPPING BOARD
CGCB2

- Toughened glass
- 325 x 440mm



BEECH CHOPPING BOARD
AXLCB

- Beech
- 217 x 397mm



ROWECA ANTHRACITE CHOPPING BOARD
VACB

- Roweca Anthracite
- 250 x 440mm
- Dishwasher friendly



CRAMER CERAMIC REPAIR KIT
REPAIRKIT



CRAMER TAP CLEANER
TAPCLEAN



CRAMER CERAMIC TOUCH-UP STICK
TOUCHUP



EMAIL-STAR POLISH SINKCLEAN

- Stainless steel or ceramic sink polish



GRANCLEAN2
GRANCLEAN

- Granite sink cleaner



CERAMIC SINK RUBBER
RUBBER

TAPS

Today's taps are more than just functional objects, they are mini works of art. With so many design styles and types of technology to choose from the right tap can set the tone for your entire kitchen.

WHAT'S YOUR TYPE?



VAPOS 3IN1 STEAMING WATER TAP

Whether you want to make a hot beverage, blanch vegetables or reduce boiling time for pasta, Vapos 3in1 taps have an instant supply of 98°C steaming water. As well as a supply of fresh cold water and regular hot water. And, the incredibly advanced filtration system means it provides the best water quality possible.



SINGLE CONTROL

Simplicity itself, with everything controlled by a single lever – move it left and right for temperature, or up and down for pressure.



PULL-OUT SPRAY

The only tap for professionals, our stylish range is brilliantly designed, with some models providing a minimum pressure rate of 0.3 bar.



DUAL CONTROL

Added control and ease of use, with a dedicated lever controlling both hot and cold water.



CAPLE PURITI

With a Caple Puriti filter tap you can have ordinary hot and cold water, as well as purified water from one single fitting – as an extra lever diverts water through the filter. The activated carbon filter removes chlorine, rust and sediment so you can feel better about the water you consume. You might also find it improves the taste! Each filter lasts approximately six months and can easily be changed without tools.

To order your replacement filters go to www.caple.co.uk for next day delivery.

caple
PURITI

THE INSIDE STORY

Taps aren't as simple as they look. How they work can be quite technical. Before you make your choice here are some things to consider.



WRAS APPROVED

The Water Regulations Advisory Scheme (WRAS) is the UK Water Industry's approval scheme.

Our range of WRAS approved taps have been fully tested and are fully compliant with the requirements of the water regulations and byelaws. WRAS Approval is considered the best way to demonstrate compliance as it is granted directly by representatives of the water suppliers and is therefore accepted by every water supplier in the UK.

VALVE TYPES

You can choose from many different valve options to control how your tap works. In a single lever model, the lever is moved in two directions to control the tap. Other types of tap use either basic compression valves or the superior quarter turn valves that respond quicker.

WATER PRESSURE

Some taps need more pressure than others to flow at the same rate. A pressurised water heater system will provide enough water pressure for any of our taps. However, an unpressurised system may not. You will need to calculate the pressure before choosing a tap that has a minimum requirement – otherwise it might not work properly. To do this, measure how far the water tank is above the tap in metres and divide by 10. This gives the water pressure in bars. Remember that any bends or junctions in the pipework will reduce the pressure.

If you are not sure how to calculate your hot water pressure, ask your plumber. Water pressure can be increased by adding a separate water pump.

WATER EFFICIENT CSH COMPLIANT TAPS

We have developed a collection of taps specifically designed to conform with the water flow required for the Code for Sustainable Homes [CSH] Level 3. These taps have a flow rate of 4 litres per minute or less when measured at 3 bar of pressure. Look out for the water efficiency logo.



SINGLE FLOW

In a single flow tap, there is one channel for hot and cold water to get the correct temperature required.

DUAL FLOW

Added control and ease of use, with a dedicated lever controlling both hot and cold water.

STAINLESS STEEL

At Caple we don't believe in compromise. Our taps are made from the highest grade stainless steel, giving our stainless steel taps great resistance to corrosion.



Stainless steel is much more than a different look and finish. Unlike chrome taps, stainless steel taps do not have a coating, they are solid steel. Also known as Inox steel, it is an alloy with a 10%+ chromium content and this is what makes it so resistant. The chromium content forms a passive film of chromium oxide on the metal surface protecting the tap.

But our taps are not only tough and well engineered but beautifully styled. Styles from the more classic to the absolute contemporary and with 19 in the range to choose from you are spoilt for choice. Of course, the stainless steel tap range particularly complements our range of stainless steel sinks. Bring them together and they add a great finishing touch to any kitchen.

Stainless
STEEL



VAPOS 3IN1 STEAMING WATER TAP

Vapos taps supply fresh cold water, regular hot water and filtered 98°C steaming water, the perfect temperature for preparing tea, blanching vegetables and assisting the cooking of pasta or rice.



Water conditioning technology provides exceptional accuracy for scale and acidity control for increased boiler protection, this means outstanding food and beverage quality.

Quick and simple installation allows the tap, filter and boiler to be easily retrofitted. Finished in stunning stainless steel, Vapos taps exude style and practicality.

OUTSTANDING WATER FILTRATION

Offering a new standard of water filtration technology, providing extraordinary accuracy for scale and PH control. This water filtration and conditioning technology effectively combines hardness reduction, mineral stabilization and corrosion inhibition by maintaining a controlled low carbonic acid level in the water.

It delivers the best available water quality for hot drinks by removing lime scale build up in the boiler [provided filters are installed and maintained/exchanged in line with manufacturer recommendations].

It includes DuoBlend® valve technology for the most accurate bypass ratio and a 5µm Carbon block membrane for particle protection, reducing tastes and odours such as chlorine and chlorine by-products, THM's, PAH's and pesticides such as Simazine, Atrazine, Lindane and Dieldrin. Each filter lasts approximately six months and is easily changed without tools.

Order your replacement filter cartridge [PURIT13] or full fitting kit including the cartridge [PURIT14] at WWW.CAPLE.CO.UK for next day delivery.



Filter and fixing kit available to buy online at www.caple.co.uk

Boiler dimensions: width 200mm, height 290mm, depth 225mm

LARGE BOILER

A large boiler capacity means 2.4 litres of steaming water is ready for use whenever you need it. With a temperature range of 50°C–98°C it uses less electricity than a 40W light bulb.

All caple accessories are available to buy online at www.caple.co.uk

VAPOS 3IN1



PRODUCT CODE
VAP3IN1/SS

FINISH AVAILABLE
Solid stainless steel

- GENERAL FEATURES
- Supplies fresh cold water, regular hot water and filtered 98°C steaming water
 - WRAS approved
 - Water conditioning technology providing exceptional accuracy for scale and acidity control for increased boiler protection, plus increased food and beverage quality.
 - 2.4Ltr tank, up to 100 cups per hour
 - Temperature range of boiler 50°C to 98°C

- TAP FEATURES
- Minimum 0.5 bar pressure required
 - Safety mechanism for steaming water control
 - Cool touch spout
 - Separate flow for steaming water

OPTIONAL EXTRAS
Available to buy online www.caple.co.uk
PURIT13 Replacement filter

DIMENSIONS

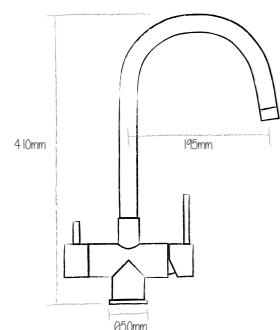

Worktop cut out 35mm required

VAPOS QUAD 3IN1



PRODUCT CODE
VAPQ3IN1/SS

FINISH AVAILABLE
Solid stainless steel

- GENERAL FEATURES
- Supplies fresh cold water, regular hot water and filtered 98°C steaming water
 - WRAS approved
 - Water conditioning technology providing exceptional accuracy for scale and acidity control for increased boiler protection, plus increased food and beverage quality.
 - 2.4Ltr tank, up to 100 cups per hour
 - Temperature range of boiler 50°C to 98°C

- TAP FEATURES
- Minimum 0.5 bar pressure required
 - Safety mechanism for steaming water control
 - Cool touch spout
 - Separate flow for steaming water

OPTIONAL EXTRAS
Available to buy online www.caple.co.uk
PURIT13 Replacement filter

DIMENSIONS

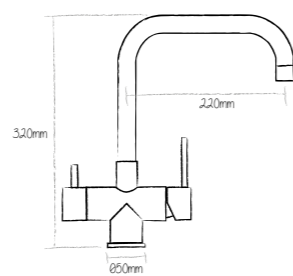

Worktop cut out 35mm required

SO, HERE'S THE TECHNICAL BIT...

The cold water from your water supply passes through the filter into the 2.4L boiler. The water temperature can be easily adjusted from 50°C – 98°C to suit your requirements by simply turning the dial located at the front of the boiler.

For steaming water use the smaller lever on the left hand side of the tap. Push down the lever to release the child safety mechanism then turn and hold to start a steady flow of steaming water, when you are finished the unique spring loaded lever automatically shuts off the steaming water.

It couldn't be easier to change the filter. There is no need to cut off the water supply, just twist the used filter to release it – this automatically isolates the water supply making it easy to twist the new cartridge into place.

All Caple accessories are available to buy at www.caple.co.uk for next day delivery.

Features



PERFECT CUP OF TEA

Due to the technologically advanced filtration system all the water's impurities are reduced, even in hard water areas. Fantastic filtration means you get the best quality tea every time.

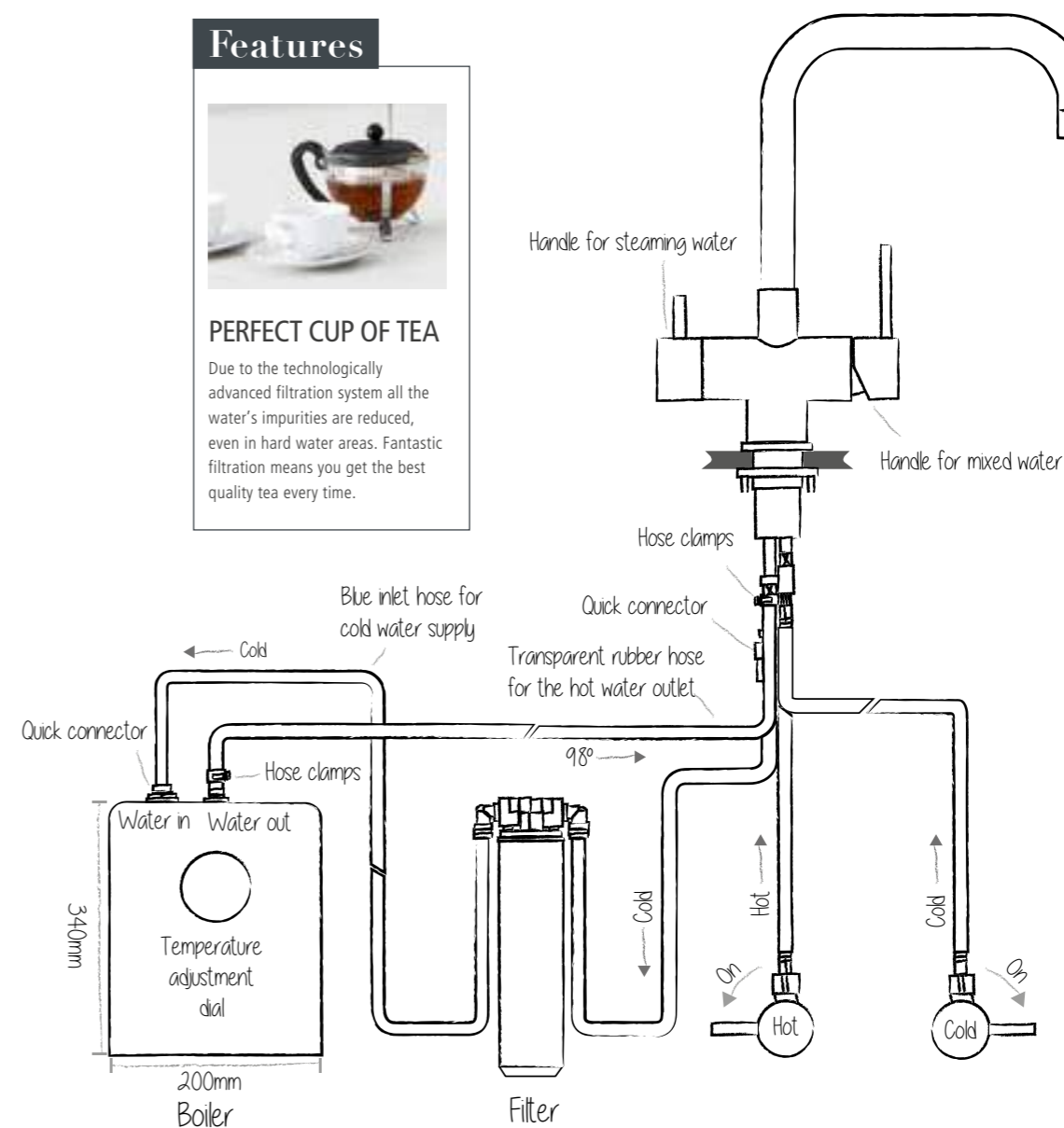

Replacement filters and fixing kits are available to buy online at www.caple.co.uk

PURITI

Fancy purified, filtered cold water on tap?



Choose a Caple Puriti tap to deliver regular hot and cold water with the added benefit of fresh filtered water. It is either dispensed using a third lever or sometimes fully integrated into the standard design.

An ingenious filtration system is hidden from sight in the kitchen unit, and by turning the filtration tap, your normal cold water supply is diverted via the Caple filter to the tap and in to your glass. It is also great for areas with particularly hard water. By using the filtered water in kettles and cooking you greatly reduce the damaging impact of lime-scale build up in appliances and reduce the effect of water impurities during food preparation, whilst also improving tea and coffee.

caple
PURITI

As the filter tap is turned the normal cold water supply is redirected through a series of filtration processes including activated carbon. This removes almost all chlorine improving the taste, and other impurities such as particulates, bacteria, rust, heavy metals and pesticides, while also acting as a scale inhibitor. It also helps maintain the pH balance of the water, which is much healthier than consuming overly acidic or alkaline normal tap water.

Caple Puriti filter can last up to 4 x longer compared to other filtration systems on the market. Puriti filters up to 6000 litres compared to only 300 – 1500 litres.

The Caple Puriti filter is discreetly installed under the sink. It will be easily accessible for changing which will need to be done about every six months. This is a very straight-forward process that does not require any tools.

Features

HOW TO REPLACE YOUR FILTER

Replacing your filter is simple and straightforward. Watch our step by step video on our YouTube channel, CapleTV.





ARDOR PURITI

PRODUCT CODE
ARDPUR/CH

FINISH AVAILABLE
 Polished chrome

- GENERAL FEATURES
- Monobloc design
 - Minimum 0.3 bar pressure required
 - Quarter turn ceramic valve
 - Single flow
 - Separate filtered supply [filter included]

OPTIONAL EXTRAS
Available to buy online
www.caple.co.uk

PURITI1 Replacement filter



↔ DIMENSIONS

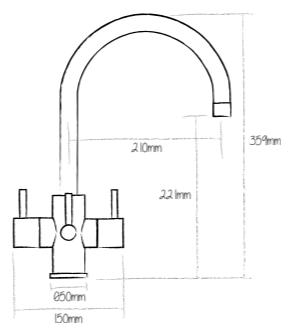

Worktop cut out 35mm required

ATMORE PURITI



PRODUCT CODE
ATMPUR/CH

FINISH AVAILABLE
 Polished chrome

- GENERAL FEATURES
- Monobloc design
 - Minimum 0.1 bar pressure required
 - Single lever ceramic valve
 - Single flow
 - Separate filtered supply [filter included]

OPTIONAL EXTRAS
Available to buy online
www.caple.co.uk
PURITI1 Replacement filter

↔ DIMENSIONS

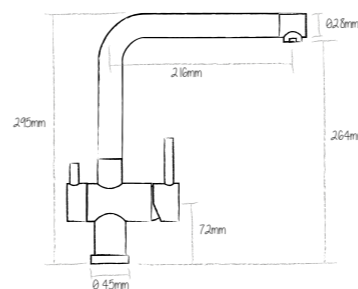

Worktop cut out 35mm required

DALTON PURITI



PRODUCT CODE
DALPUR2/SS

FINISH AVAILABLE
 Solid stainless steel

- GENERAL FEATURES
- Monobloc design
 - Minimum 0.5 bar pressure required
 - Quarter turn lever for filtered water
 - Single lever ceramic valve for hot and cold water
 - Single flow for hot and cold water
 - Separate filtered supply [filter included]

OPTIONAL EXTRAS
Available to buy online
www.caple.co.uk
PURITI1 Replacement filter

↔ DIMENSIONS

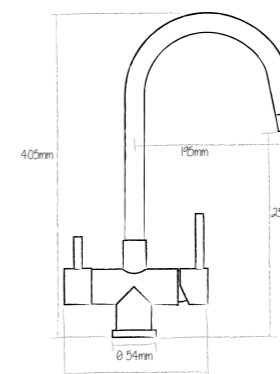

Worktop cut out 35mm required

DALTON QUAD PURITI



PRODUCT CODE
DALQPUR2/SS

FINISH AVAILABLE
 Solid stainless steel

- GENERAL FEATURES
- Monobloc design
 - Minimum 0.5 bar pressure required
 - Quarter turn ceramic valve lever for filtered water
 - Single lever ceramic valve for hot and cold water
 - Single flow for hot and cold water
 - Separate filtered supply [filter included]

OPTIONAL EXTRAS
Available to buy online
www.caple.co.uk
PURITI1 Replacement filter

↔ DIMENSIONS

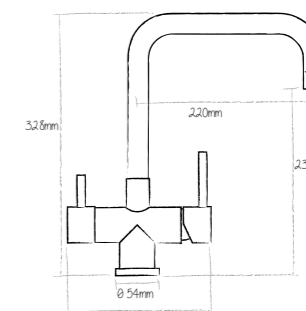

Worktop cut out 35mm required

NATICK PURITI



PRODUCT CODE
NATPUR/CH

FINISH AVAILABLE
 Polished chrome

- GENERAL FEATURES
- Monobloc design
 - Minimum 0.3 bar pressure required
 - Quarter turn ceramic valve
 - Single flow
 - Separate filtered supply [filter included]

OPTIONAL EXTRAS
 Available to buy online
www.caple.co.uk
 PURIT1 Replacement filter

↔ DIMENSIONS

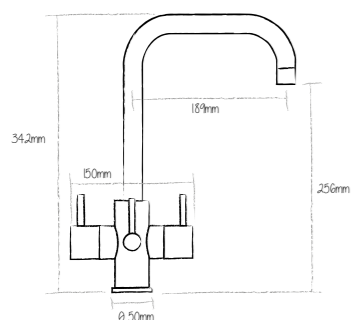

Worktop cut out 35mm required

LAYTON PURITI



PRODUCT CODE
LAYPUR2/SS

FINISH AVAILABLE
 Solid stainless steel

- GENERAL FEATURES
- Single lever design
 - Minimum 0.5 bar pressure required
 - Quarter turn ceramic valve
 - Single flow
 - FILTERED SUPPLY ONLY [filter included]

OPTIONAL EXTRAS
 Available to buy online
www.caple.co.uk
 PURIT1 Replacement filter

↔ DIMENSIONS

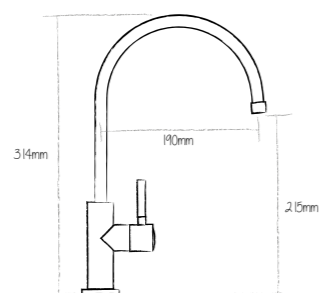

Worktop cut out 20mm required

SALUS PURITI



PRODUCT CODE
SALPUR/CH

FINISH AVAILABLE
 Polished chrome

- GENERAL FEATURES
- Single lever design
 - Minimum 0.3 bar pressure required
 - Single lever ceramic valve
 - Single flow
 - FILTERED SUPPLY ONLY [filter included]

OPTIONAL EXTRAS
 Available to buy online
www.caple.co.uk
 PURIT1 Replacement filter

↔ DIMENSIONS

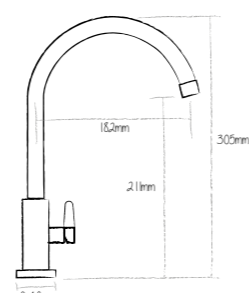

Worktop cut out 22mm required



PULL-OUT AND SPRAY



More and more of us no longer see our kitchens as a place where we merely make something to eat but a place to experiment with new tastes and new techniques. A place to enjoy the preparation and creation of food for family and friends.

We are spending more and more time in our kitchens. Never has it been more true that they are the heart of the home.

Therefore, the demands and expectations from our kitchens, the appliances and the fittings also become more demanding. This is where Caple's range of spray taps step up to the plate.

With technology taken from professional kitchens they work on the same principle as a single lever tap design with the standard hot and cold functions.

However on some models the nozzle pulls out on an extended, flexible metal hose. By pressing the button on the side of the spray head the nozzle produces a high pressured spray or jet of water.

This is perfect for washing vegetables or fast rinsing of plates and crockery. No busy kitchen or accomplished cook should be without one.

PULL-OUT SPRAY TAPS

The powerful spray makes it so much easier to wash and rinse items. Used in most professional kitchens worldwide, it's a must-have for accomplished chefs.

The secret is in the nozzle. As well as a powerful spray, some models have a long flexible hose that can be pulled out allowing you to move the tap freely around the sink.



ATLANTA PULL-OUT



Features

360° PIVOT

Seamless body with 360° pivot at the base



PRODUCT CODE
ATLP/SS

FINISH AVAILABLE
Solid stainless steel

GENERAL FEATURES

- Single lever design
- Seamless body with 360° pivot at the base
- Grey braided pull-out hose
- Minimum 0.5 bar pressure required
- Single lever ceramic valve
- Single flow

DIMENSIONS

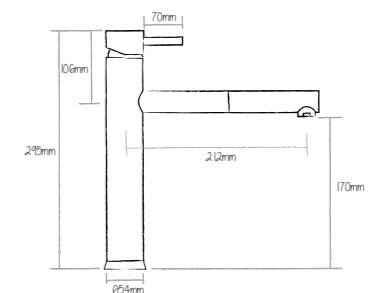

Worktop cut out 35mm required

ASPEN PULL-OUT CHROME



PRODUCT CODE
ASPS2/CH

FINISH AVAILABLE
 Polished chrome

- GENERAL FEATURES
- Pull-out design
 - Minimum 0.5 bar pressure required
 - Single lever ceramic valve
 - Single flow
 - Extendable hose

ASPEN PULL-OUT STAINLESS STEEL



PRODUCT CODE
ASPS2/SS

FINISH AVAILABLE
 Solid stainless steel

- GENERAL FEATURES
- Pull-out design
 - Minimum 0.5 bar pressure required
 - Single lever ceramic valve
 - Single flow
 - Extendable hose

BROOKLINE PULL-OUT



PRODUCT CODE
BRO/SP/CH

FINISH AVAILABLE
 Polished chrome

- GENERAL FEATURES
- Single lever design
 - Minimum 0.5 bar pressure required
 - Single lever ceramic valve
 - Single flow
 - Extendable hose
 - 180° swivel spout

FREEMONT PULL-OUT SPRAY



PRODUCT CODE
FRE/CH

FINISH AVAILABLE
 Polished chrome

- GENERAL FEATURES
- Single lever design
 - Minimum 0.3 bar pressure required
 - Single lever ceramic valve
 - Single flow
 - Push button spray head
 - Extendable hose

HOWE PROFESSIONAL PULL-OUT



PRODUCT CODE
HOW/SS

FINISH AVAILABLE
 Solid stainless steel

- GENERAL FEATURES
- Single lever design
 - Brushed stainless steel
 - Minimum 0.5 bar pressure required
 - Single lever ceramic valve
 - Single flow
 - Extendable hose

LANDIS PULL-OUT



PRODUCT CODE
LAN/SP/CH

FINISH AVAILABLE
 Polished chrome

- GENERAL FEATURES
- Single lever design
 - Minimum 0.3 bar pressure required
 - Single lever ceramic valve
 - Single flow
 - Extendable hose

↔ DIMENSIONS

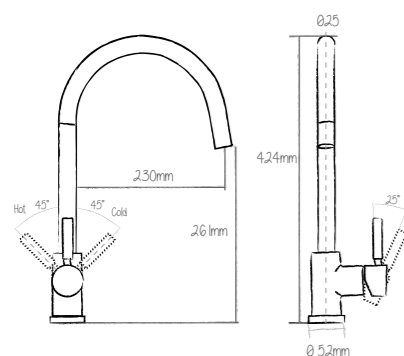

Worktop cut out 35mm required
Note: Pull-out hose extended by 650mm

↔ DIMENSIONS

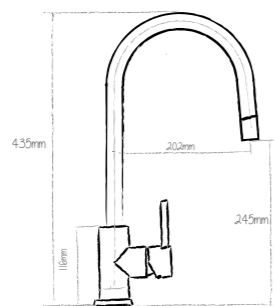

Worktop cut out 35mm required
Note: Pull-out hose extended by 500mm

↔ DIMENSIONS

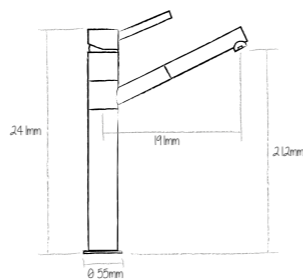

Worktop cut out 35mm required
Note: Pull-out hose extended by 650mm

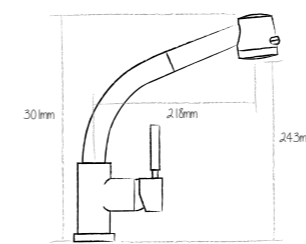

Worktop cut out 35mm required
Note: Pull-out hose extended by 500mm

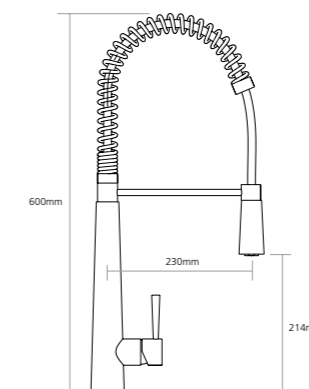

Worktop cut out 35mm required
Note: Pull-out hose extended by 600mm

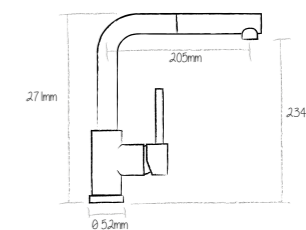

Worktop cut out 35mm required
Note: Pull-out hose extended by 660mm

LANGLEY PULL-OUT SPRAY



PRODUCT CODE
LAG/CH

FINISH AVAILABLE
 Polished chrome

- GENERAL FEATURES
- Single lever design
 - Minimum 0.5 bar pressure required
 - Single lever ceramic valve
 - Single flow
 - Push button spray head
 - Extendable hose

NAVITIS STAINLESS STEEL SPRAY



Stainless STEEL

PRODUCT CODE
NAV/SS

FINISH AVAILABLE
 Solid stainless steel

- GENERAL FEATURES
- Single lever design
 - Minimum 0.5 bar pressure required
 - Single lever ceramic valve
 - Single flow
 - Push button spray head

NAVITIS BLACK SPRAY



Stainless STEEL

PRODUCT CODE
NAV/BK

FINISH AVAILABLE
 Solid stainless steel with black silicone hose

- GENERAL FEATURES
- Single lever design
 - Minimum 0.5 bar pressure required
 - Single lever ceramic valve
 - Single flow
 - Push button spray head

NAVITIS POLISHED CHROME



PRODUCT CODE
NAV/CH

FINISH AVAILABLE
 Polished chrome

- GENERAL FEATURES
- Single lever design
 - Minimum 0.5 bar pressure required
 - Single lever ceramic valve
 - Single flow

NOVATO SPRAY TAP



Stainless STEEL

PRODUCT CODE
NOV/SS

FINISH AVAILABLE
 Solid stainless steel

- GENERAL FEATURES
- Monobloc design
 - Minimum 0.5 bar pressure required
 - Quarter turn ceramic valves
 - Single flow

RAWLING SPRAY



PRODUCT CODE
RAW/CH

FINISH AVAILABLE
 Polished chrome and black

- GENERAL FEATURES
- Single lever design
 - Minimum 0.5 bar pressure required
 - Single lever ceramic valve
 - Single flow
 - Push button spray head
 - Black hose

↔ DIMENSIONS

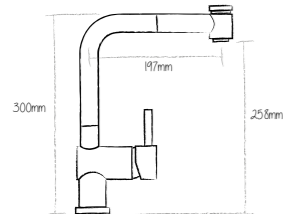

Worktop cut out 35mm required
Note: Pull-out hose extended by 460mm

↔ DIMENSIONS

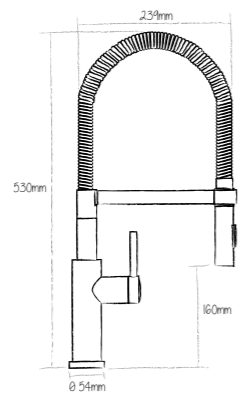

Worktop cut out 35mm required

↔ DIMENSIONS

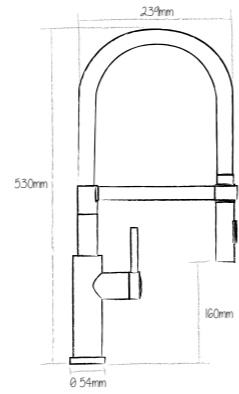

Worktop cut out 35mm required

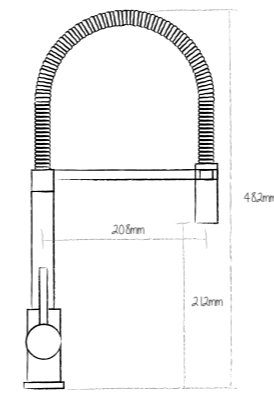

Worktop cut out 35mm required

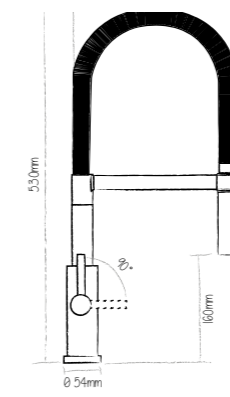

Worktop cut out 35mm required

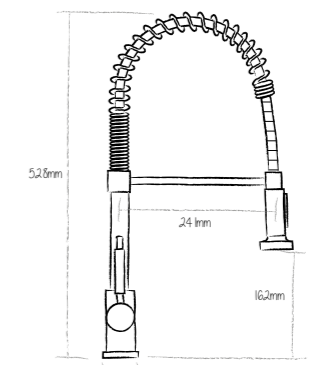

Worktop cut out 35mm required

**SPIRO STAINLESS STEEL
PULL-OUT SPRAY**



PRODUCT CODE
SPI2/SS

FINISH AVAILABLE
 Solid stainless steel

- GENERAL FEATURES
- Single lever design
 - Minimum 0.5 bar pressure required
 - Single lever ceramic valve
 - Single flow
 - Push button spray head
 - Grey extendable hose

**SPIRO POLISHED
CHROME PULL-OUT SPRAY**



PRODUCT CODE
SPI/CH

FINISH AVAILABLE
 Polished chrome

- GENERAL FEATURES
- Single lever design
 - Minimum 0.5 bar pressure required
 - Single lever ceramic valve
 - Single flow
 - Push button spray head
 - Extendable hose

**TORRENT PROFESSIONAL
PULL-OUT SPRAY**



PRODUCT CODE
TOR/CH

FINISH AVAILABLE
 Polished chrome

- GENERAL FEATURES
- Single lever design
 - Minimum 0.5 bar pressure required
 - Single lever ceramic valve
 - Single flow
 - Push button spray head
 - Extendable hose



↔ DIMENSIONS

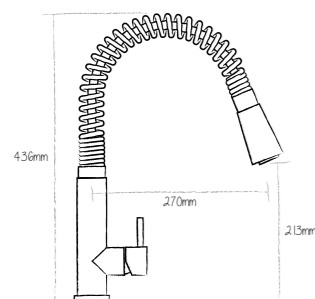

Worktop cut out 35mm required
Note: Pull-out hose extended by 600mm

↔ DIMENSIONS

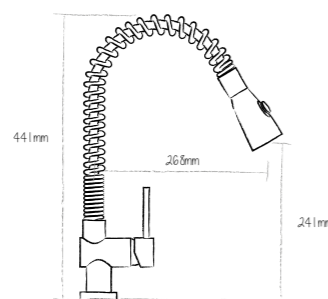

Worktop cut out 35mm required
Note: Pull-out hose extended by 410mm

↔ DIMENSIONS

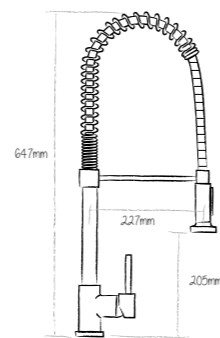

Worktop cut out 35mm required
Note: Pull-out hose extended by 600mm



SINGLE CONTROL

ENDLESS CHOICE

With Caple's single control taps you can be sure that the engineering that goes in to one of our taps is second to none. Smooth gliding operation, robust seals and a solid finish. So now all you have to do is decide which style and finish is best for you. With various finishes in so many designs from the classic to the contemporary, it may be harder task than you think.

SINGLE LEVER SIMPLICITY

Everything controlled by a single lever – move it left and right for temperature, or up and down for pressure.



EASY AND ADAPTABLE

Single control or single lever taps have stood the test of time. It is testimony to their ease of use and adaptability to great design.

ASPEN STAINLESS STEEL



Stainless STEEL

PRODUCT CODE
ASP2/SS

FINISH AVAILABLE
 Solid stainless steel

- GENERAL FEATURES
- Single lever design
 - Minimum 0.5 bar pressure required
 - Single lever ceramic valve
 - Single flow

ASPEN POLISHED CHROME



PRODUCT CODE
ASP2/CH

FINISH AVAILABLE
 Polished chrome

- GENERAL FEATURES
- Single lever design
 - Minimum 0.3 bar pressure required
 - Single lever ceramic valve
 - Single flow

ASPEN QUAD STAINLESS STEEL



Stainless STEEL

PRODUCT CODE
ASPQ2/SS

FINISH AVAILABLE
 Solid stainless steel

- GENERAL FEATURES
- Single lever design
 - Minimum 0.5 bar pressure required
 - Single lever ceramic valve
 - Single flow

ASPEN QUAD POLISHED CHROME



PRODUCT CODE
ASPQ2/CH

FINISH AVAILABLE
 Polished chrome

- GENERAL FEATURES
- Single lever design
 - Minimum 0.5 bar pressure required
 - Single lever ceramic valve
 - Single flow

ATLANTA STAINLESS STEEL



Stainless STEEL

PRODUCT CODE
ATL/SS

FINISH AVAILABLE
 Solid stainless steel

- GENERAL FEATURES
- Single lever design
 - Seamless body with 360° pivot at the base
 - Minimum 0.5 bar pressure required
 - Single lever ceramic valve
 - Single flow

ATLANTA POLISHED CHROME



PRODUCT CODE
ATL2/CH

FINISH AVAILABLE
 Polished chrome

- GENERAL FEATURES
- Single lever design
 - Minimum 0.5 bar pressure required
 - Single lever ceramic valve
 - Single flow

Features

360° PIVOT

Seamless body with 360° pivot at the base



↔ DIMENSIONS

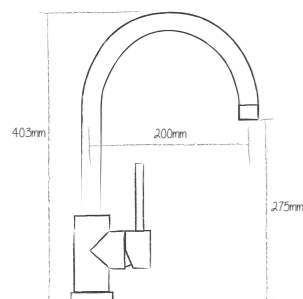

Worktop cut out 35mm required

↔ DIMENSIONS

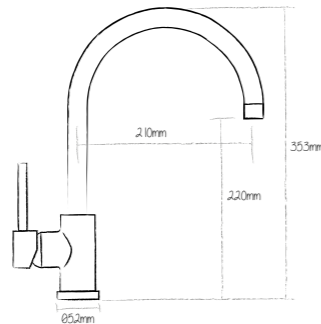

Worktop cut out 35mm required

↔ DIMENSIONS

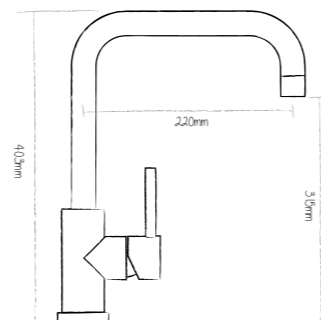

Worktop cut out 35mm required

↔ DIMENSIONS

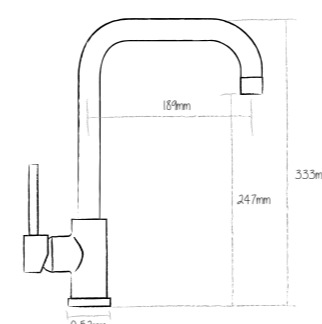

Worktop cut out 35mm required

↔ DIMENSIONS

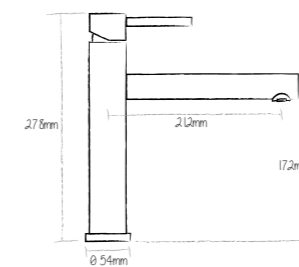

Worktop cut out 35mm required

↔ DIMENSIONS

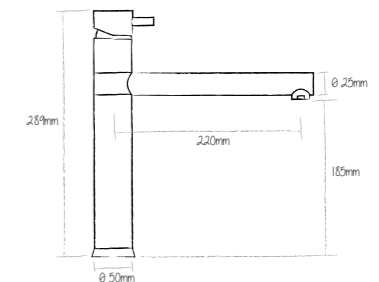

Worktop cut out 35mm required

BROOKLINE



PRODUCT CODE
BRO/CH

FINISH AVAILABLE
 Polished chrome

- GENERAL FEATURES
- Single lever design
 - Minimum 0.3 bar pressure required
 - Single lever ceramic valve
 - Adjustable nozzle
 - Single flow

CORY



Stainless
STEEL

PRODUCT CODE
COR/SS

FINISH AVAILABLE
 Solid stainless steel

- GENERAL FEATURES
- Single lever design
 - Minimum 0.3 bar pressure required
 - Single lever ceramic valve
 - Single flow

DANVERS



PRODUCT CODE
DAN/CH

FINISH AVAILABLE
 Polished chrome

- GENERAL FEATURES
- Single lever design
 - Minimum 0.1 bar pressure required
 - Single lever ceramic valve
 - Single flow

DELTA



PRODUCT CODE
DEL/CH

FINISH AVAILABLE
 Polished chrome

- GENERAL FEATURES
- Single lever design
 - Minimum 0.5 bar pressure required
 - Single lever ceramic valve
 - Single flow

DUMAS



PRODUCT CODE
DUM/CH

FINISH AVAILABLE
 Polished chrome

- GENERAL FEATURES
- Single lever design
 - Minimum 0.3 bar pressure required
 - Single lever ceramic valve
 - Single flow

FRESNO



PRODUCT CODE
FRS/CH

FINISH AVAILABLE
 Polished chrome

- GENERAL FEATURES
- Single lever design
 - Minimum 0.3 bar pressure required
 - Single lever ceramic valve
 - Single flow

↔ DIMENSIONS

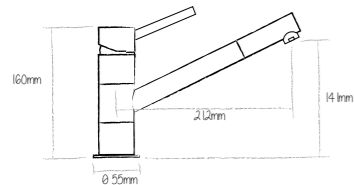

Worktop cut out 35mm required

↔ DIMENSIONS

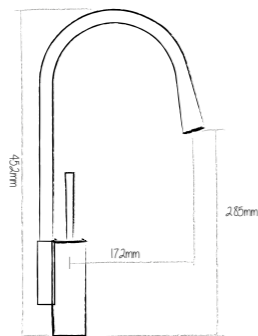

Worktop cut out 35mm required

↔ DIMENSIONS

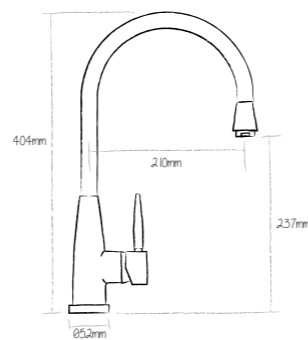

Worktop cut out 35mm required

↔ DIMENSIONS

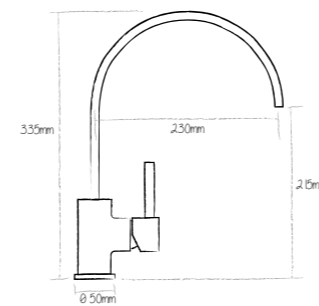

Worktop cut out 35mm required

↔ DIMENSIONS

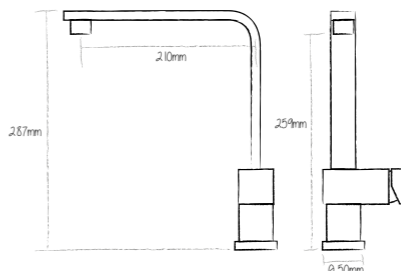

Worktop cut out 35mm required

↔ DIMENSIONS

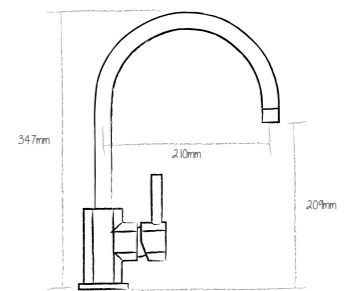

Worktop cut out 35mm required



KARNSS COPPER



PRODUCT CODE
KAR/CO

FINISH AVAILABLE
Copper

- GENERAL FEATURES
- Solid stainless steel with copper finish
 - Single lever design
 - Minimum 0.5 bar pressure required
 - Single lever ceramic valve
 - Single flow

KARNSS STAINLESS STEEL



PRODUCT CODE
KAR/SS

FINISH AVAILABLE
Solid stainless steel

- GENERAL FEATURES
- Single lever design
 - Minimum 0.5 bar pressure required
 - Single lever ceramic valve
 - Single flow

KARNSS BLACK



PRODUCT CODE
KAR/BK

FINISH AVAILABLE
Chromite black

- GENERAL FEATURES
- Solid stainless steel with chromite black finish
 - Single lever design
 - Minimum 0.5 bar pressure required
 - Single lever ceramic valve
 - Single flow

KARNSS GUNMETAL



PRODUCT CODE
KAR/GM

FINISH AVAILABLE
Gunmetal

- GENERAL FEATURES
- Solid stainless steel with gunmetal finish
 - Single lever design
 - Minimum 0.5 bar pressure required
 - Single lever ceramic valve
 - Single flow

↔ DIMENSIONS

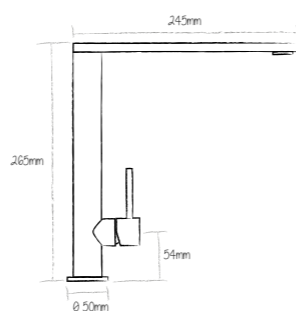

Worktop cut out 35mm required

↔ DIMENSIONS

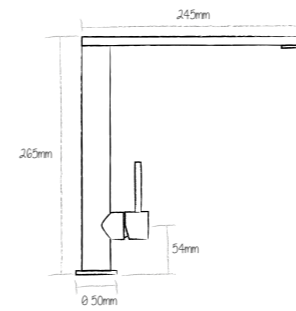

Worktop cut out 35mm required

↔ DIMENSIONS

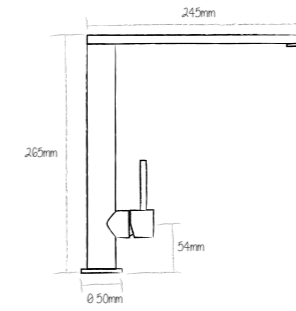

Worktop cut out 35mm required

↔ DIMENSIONS

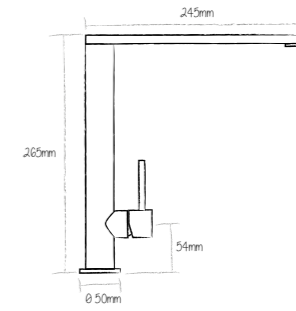

Worktop cut out 35mm required

**HAYDEN
STAINLESS STEEL**



Stainless
STEEL

PRODUCT CODE
HAY/SS

FINISH AVAILABLE
Solid stainless steel

- GENERAL FEATURES
- Single lever design
 - Seamless body with 360° pivot at the base
 - Minimum 0.5 bar pressure required
 - Single lever ceramic valve
 - Single flow

LANDIS



PRODUCT CODE
LAN/CH

FINISH AVAILABLE
Polished chrome

- GENERAL FEATURES
- Single lever design
 - Minimum 0.3 bar pressure required
 - Adjustable nozzle
 - Single lever ceramic valve
 - Single flow

NEWARK



PRODUCT CODE
NEW/CH

FINISH AVAILABLE
Polished chrome

- GENERAL FEATURES
- Single lever design
 - Polished chrome
 - Minimum 0.3 bar pressure required
 - Single lever ceramic valve
 - Single flow

RIDLEY GUNMETAL



PRODUCT CODE
RID/GM

FINISH AVAILABLE
Gunmetal

- GENERAL FEATURES
- Solid stainless steel with gunmetal finish
 - Single lever design
 - Minimum 0.5 bar pressure required
 - Single lever ceramic valve
 - Single flow

RIDLEY COPPER



PRODUCT CODE
RID/CO

FINISH AVAILABLE
Copper

- GENERAL FEATURES
- Solid stainless steel with copper finish
 - Single lever design
 - Minimum 0.5 bar pressure required
 - Single lever ceramic valve
 - Single flow

RIDLEY STAINLESS STEEL



Stainless
STEEL

PRODUCT CODE
RID/SS

FINISH AVAILABLE
Solid stainless steel

- GENERAL FEATURES
- Single lever design
 - Minimum 0.5 bar pressure required
 - Single lever ceramic valve
 - Single flow

Features

360° PIVOT

Seamless body with 360° pivot at the base



DIMENSIONS

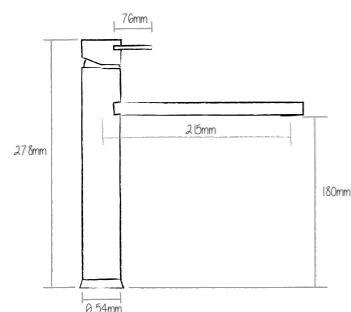

Worktop cut out 35mm required

DIMENSIONS

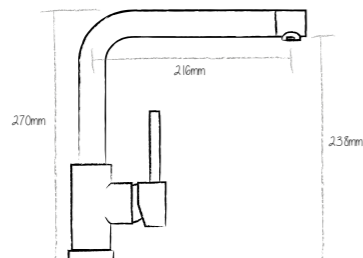

Worktop cut out 35mm required

DIMENSIONS

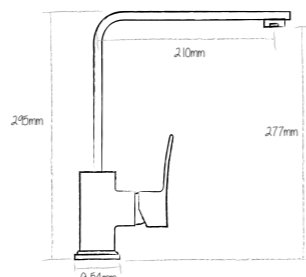

Worktop cut out 35mm required

DIMENSIONS

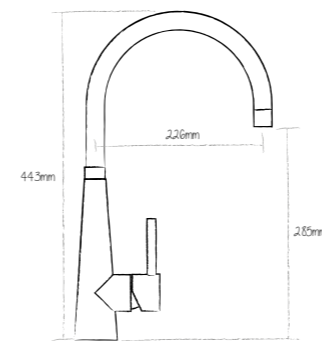

Worktop cut out 35mm required

DIMENSIONS

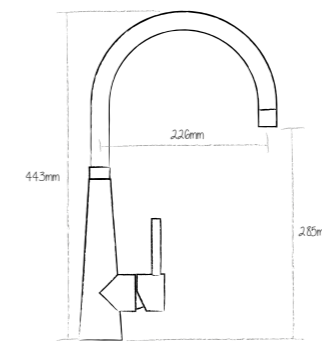

Worktop cut out 35mm required

DIMENSIONS

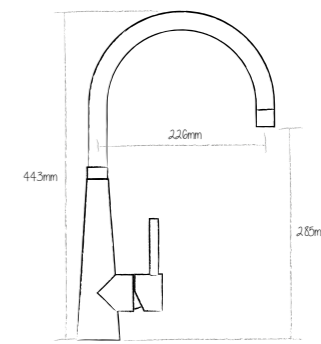

Worktop cut out 35mm required

SINGLE LEVER DELUXE

SINGLE LEVER

SWANSON

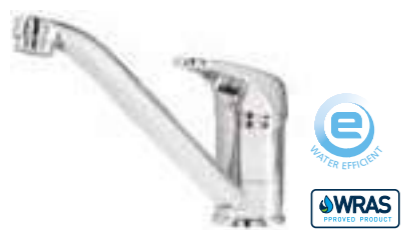

PRODUCT CODE
SLD2/CH

FINISH AVAILABLE
Polished chrome

- GENERAL FEATURES
- Single lever design
 - Minimum 0.3 bar pressure required
 - Single lever ceramic valve
 - Single flow
 - WRAS approved

The SLD2/CH has been designed to conform to the Code for Sustainable Homes [CSH] Level 3 and has a flow rate of less than 4 litres per minute at 3 bar.



PRODUCT CODE
SL6/CH

FINISH AVAILABLE
Polished chrome

- GENERAL FEATURES
- Single lever design
 - Minimum 0.3 bar pressure required
 - Single lever ceramic valve
 - Single flow
 - WRAS approved



PRODUCT CODE
SWA/CH

FINISH AVAILABLE
Polished chrome

- GENERAL FEATURES
- Single lever design
 - Minimum 0.3 bar pressure required
 - Single lever ceramic valve
 - Single flow

DUAL CONTROL



CLASSIC, COOL AND CONTEMPORARY

Classic does not mean old fashioned. For many of us dual control taps are a matter of personal preference. Hot on the left, cold on the right. It's as simple as that.

But even with the classic dual control, designs vary. There is the monobloc design or bridge design.

Choose ceramic handles to match your ceramic sink. Sleek solid stainless steel – a premium material and very contemporary. Chrome - bright and reflective. Brushed nickel – subtle and blemish free. Pewter. Distinctive with a traditional twist. All meticulously designed and beautifully engineered.

Whichever you choose you can be sure that they all have one thing in common Caple's uncompromising quality.

↔ DIMENSIONS

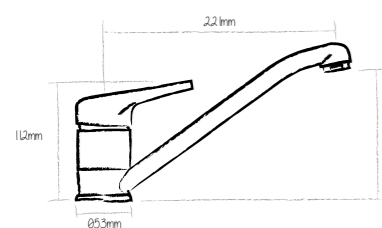

Worktop cut out 35mm required

↔ DIMENSIONS

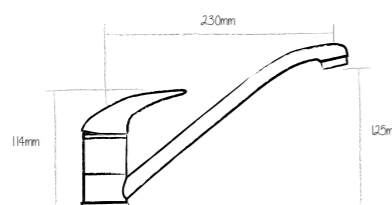

Worktop cut out 35mm required

↔ DIMENSIONS

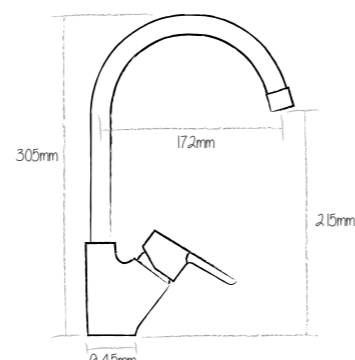

Worktop cut out 35mm required

AVEL GUNMETAL



PRODUCT CODE
AVE2/GM

FINISH AVAILABLE
Gunmetal

- GENERAL FEATURES
- Solid stainless steel with gunmetal finish
 - Monobloc design
 - Minimum 0.5 bar pressure required
 - Quarter turn ceramic valve
 - Dual flow

AVEL COPPER



PRODUCT CODE
AVE2/CO

FINISH AVAILABLE
Copper

- GENERAL FEATURES
- Solid stainless steel with copper finish
 - Monobloc design
 - Minimum 0.5 bar pressure required
 - Quarter turn ceramic valve
 - Dual flow

AVEL BRUSHED NICKEL



PRODUCT CODE
AVE4/BN

FINISH AVAILABLE
Brushed Nickel

- GENERAL FEATURES
- Monobloc design
 - Minimum 0.3 bar pressure required
 - Quarter turn ceramic valve
 - Single flow
 - WRAS approved

AVEL POLISHED CHROME



PRODUCT CODE
AVE4/CH

FINISH AVAILABLE
Polished chrome

- GENERAL FEATURES
- Monobloc design
 - Minimum 0.3 bar pressure required
 - Quarter turn ceramic valve
 - Single flow
 - WRAS approved

AVEL STAINLESS STEEL



PRODUCT CODE
AVE2/SS

FINISH AVAILABLE
Solid stainless steel

- GENERAL FEATURES
- Monobloc design
 - Minimum 0.5 bar pressure required
 - Quarter turn ceramic valve
 - Dual flow

AVEL BLACK



PRODUCT CODE
AVE2/BK

FINISH AVAILABLE
Chromite black

- GENERAL FEATURES
- Solid stainless steel with chromite black finish
 - Monobloc design
 - Minimum 0.5 bar pressure required
 - Quarter turn ceramic valve
 - Dual flow

↔ DIMENSIONS

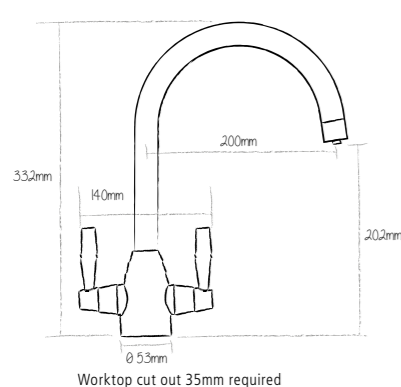

Worktop cut out 35mm required

↔ DIMENSIONS

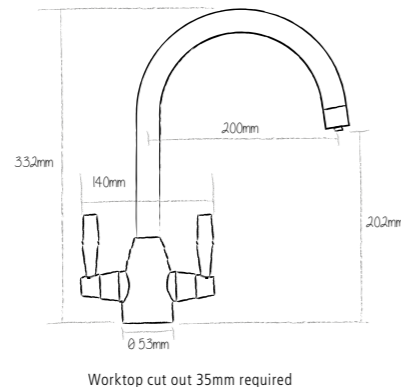

Worktop cut out 35mm required

↔ DIMENSIONS

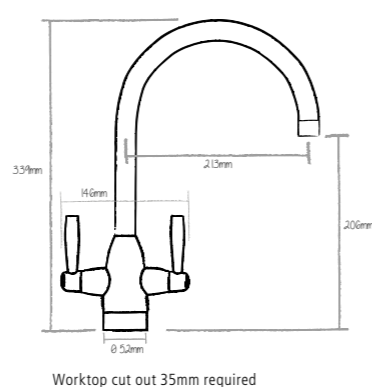

Worktop cut out 35mm required

↔ DIMENSIONS

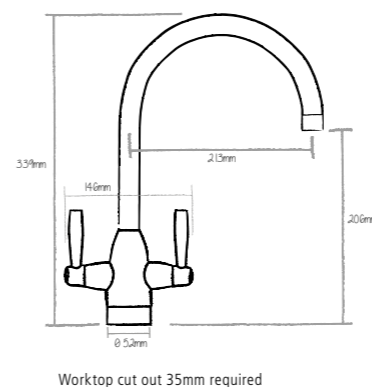

Worktop cut out 35mm required

↔ DIMENSIONS

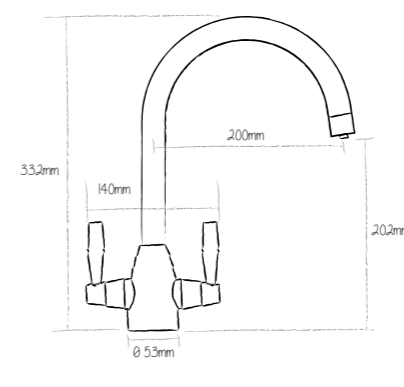

Worktop cut out 35mm required

↔ DIMENSIONS

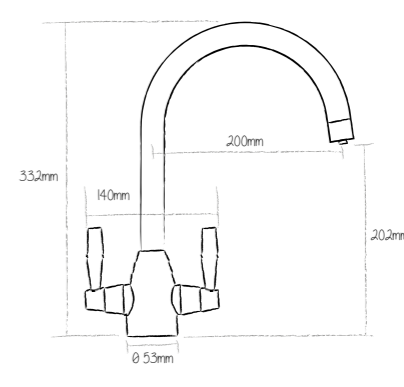

Worktop cut out 35mm required

**ANTIQUE
BRUSHED NICKEL**



PRODUCT CODE
ANT3/BN

FINISH AVAILABLE
 Brushed Nickel

- GENERAL FEATURES
- Monobloc design
 - Minimum 0.3 bar pressure required
 - Quarter turn ceramic valve
 - Single flow

**ANTIQUE
POLISHED CHROME**



PRODUCT CODE
ANT3/CH

FINISH AVAILABLE
 Polished chrome

- GENERAL FEATURES
- Monobloc design
 - Minimum 0.3 bar pressure required
 - Quarter turn ceramic valve
 - Single flow

BUCKINGHAM BRIDGE



PRODUCT CODE
B/BRI4/CH

FINISH AVAILABLE
 Polished chrome

- GENERAL FEATURES
- Bridge design
 - Minimum 0.2 bar pressure required
 - Compression valves
 - Dual flow

CRUCIFORM



PRODUCT CODE
CRU/CH

FINISH AVAILABLE
 Polished chrome

- GENERAL FEATURES
- Monobloc design
 - Minimum 0.3 bar pressure required
 - Quarter turn ceramic valves
 - Dual flow

COLTON



PRODUCT CODE
COL/CH

FINISH AVAILABLE
 Polished chrome

- GENERAL FEATURES
- Monobloc design
 - Minimum 0.3 bar pressure required
 - Quarter turn ceramic valves
 - Single flow
 - 180° swivel spout

KNIGHTSBRIDGE



PRODUCT CODE
K/BRI4/CH

FINISH AVAILABLE
 Polished chrome

- GENERAL FEATURES
- Bridge design
 - Minimum 0.2 bar pressure required
 - Quarter turn ceramic valves
 - Dual flow

NOTE: Image above shows tap levers in 'on' position

↔ DIMENSIONS

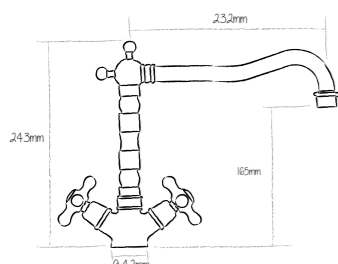

Worktop cut out 35mm required

↔ DIMENSIONS

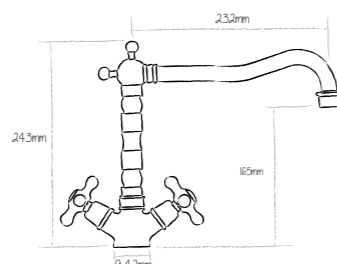

Worktop cut out 35mm required

↔ DIMENSIONS

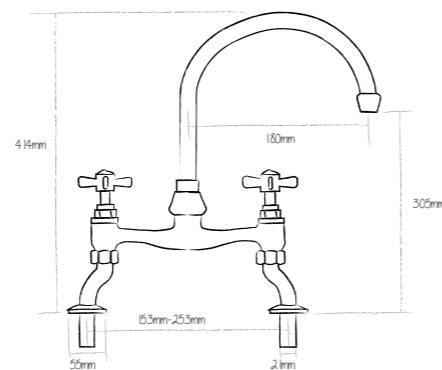

Worktop cut out 25mm required

↔ DIMENSIONS

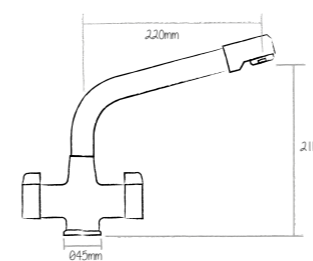

Worktop cut out 35mm required

↔ DIMENSIONS

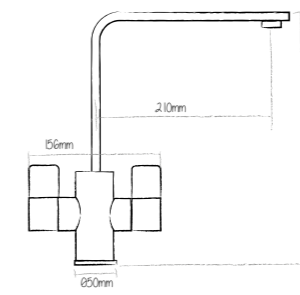

Worktop cut out 35mm required

↔ DIMENSIONS

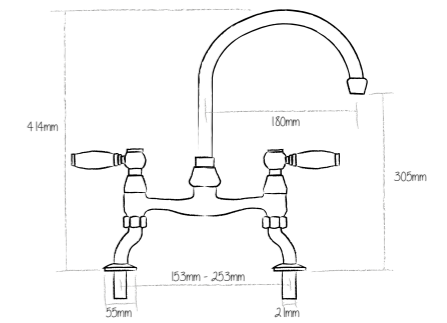

Worktop cut out 25mm required

**KONTR0
STAINLESS STEEL**



Stainless
STEEL

PRODUCT CODE
KON2/SS

FINISH AVAILABLE
Solid stainless steel

GENERAL FEATURES
- Monobloc design
- Minimum 0.5 bar pressure required
- Quarter turn ceramic valves
- Single flow

**KONTR0
POLISHED CHROME**



PRODUCT CODE
KON3/CH

FINISH AVAILABLE
Polished chrome

GENERAL FEATURES
- Monobloc design
- Minimum 0.3 bar pressure required
- Quarter turn ceramic valve
- Single flow

**LAMAR
STAINLESS STEEL**



Stainless
STEEL

PRODUCT CODE
LAM3/SS

FINISH AVAILABLE
Solid stainless steel

GENERAL FEATURES
- Monobloc design
- Minimum 0.5 bar pressure required
- Quarter turn ceramic valves
- Single flow

**LAMAR
POLISHED CHROME**



WRAS
APPROVED PRODUCT

PRODUCT CODE
LAM/CH

FINISH AVAILABLE
Polished chrome

GENERAL FEATURES
- Monobloc design
- Minimum 0.3 bar pressure required
- Quarter turn ceramic valves
- Single flow

**LEVAL
BRUSHED NICKEL**



PRODUCT CODE
LEV3/BN

FINISH AVAILABLE
Brushed Nickel

GENERAL FEATURES
- Monobloc design
- Minimum 0.3 bar pressure required
- Quarter turn ceramic valves
- Single flow

**LEVAL
POLISHED CHROME**



PRODUCT CODE
LEV3/CH

FINISH AVAILABLE
Polished chrome

GENERAL FEATURES
- Monobloc design
- Minimum 0.3 bar pressure required
- Quarter turn ceramic valves
- Single flow

↔ DIMENSIONS

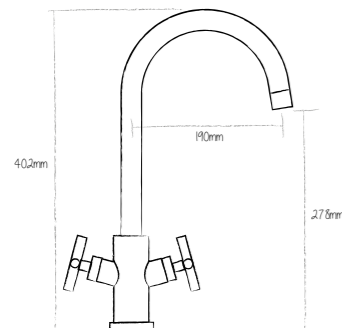

Worktop cut out 35mm required

↔ DIMENSIONS

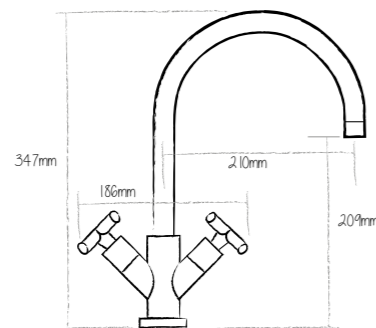

Worktop cut out 35mm required

↔ DIMENSIONS

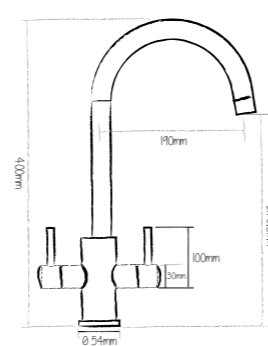

Worktop cut out 35mm required

↔ DIMENSIONS

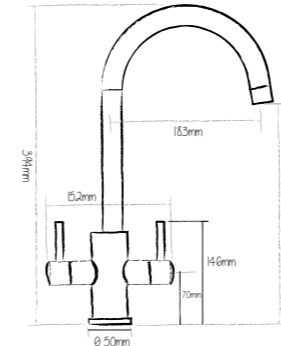

Worktop cut out 35mm required

↔ DIMENSIONS

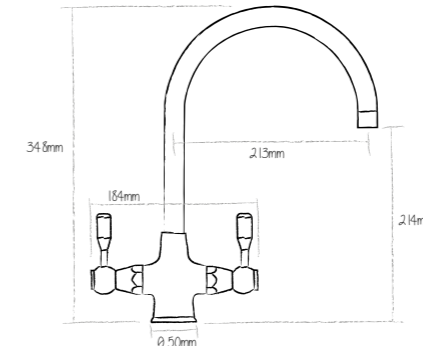

Worktop cut out 35mm required

↔ DIMENSIONS

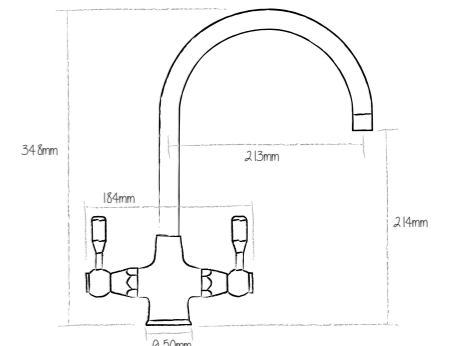

Worktop cut out 35mm required

ROBO



Stainless STEEL

PRODUCT CODE
ROB3/SS

FINISH AVAILABLE
 Solid stainless steel

GENERAL FEATURES
 - Monobloc design
 - Minimum 0.5 bar pressure required
 - Quarter turn ceramic valves
 - Single flow

**SHAFTSBURY
POLISHED CHROME**



PRODUCT CODE
S/CRU5/CH

FINISH AVAILABLE
 Polished chrome

GENERAL FEATURES
 - Monobloc design
 - Minimum 0.3 bar pressure required
 - Quarter turn ceramic valves
 - Single flow

**SHAFTSBURY
PEWTER**



PRODUCT CODE
S/CRU5/PTR

FINISH AVAILABLE
 Pewter

GENERAL FEATURES
 - Monobloc design
 - Minimum 0.3 bar pressure required
 - Quarter turn ceramic valves
 - Single flow

**WASHINGTON
POLISHED CHROME**



WRAS APPROVED PRODUCT

PRODUCT CODE
WAS4/CH

FINISH AVAILABLE
 Polished chrome

GENERAL FEATURES
 - Monobloc design
 - Minimum 0.3 bar pressure required
 - Quarter turn ceramic valves
 - Single flow
 - WRAS approved

**WASHINGTON
BRUSHED NICKEL**



PRODUCT CODE
WAS3/BN

FINISH AVAILABLE
 Brushed Nickel

GENERAL FEATURES
 - Monobloc design
 - Minimum 0.3 bar pressure required
 - Quarter turn ceramic valves
 - Single flow

ZUBEN QUAD



WATER EFFICIENT
WRAS APPROVED PRODUCT

PRODUCT CODE
ZUBQ4/CH

FINISH AVAILABLE
 Polished chrome

GENERAL FEATURES
 - Monobloc design
 - Minimum 0.3 bar pressure required
 - Quarter turn ceramic valves
 - Single flow
 - WRAS approved

The ZUBQ4/CH has been designed to conform to the Code for Sustainable Homes (CSH) Level 3 and has a flow rate of less than 4 litres per minute at 3 bar.

↔ DIMENSIONS

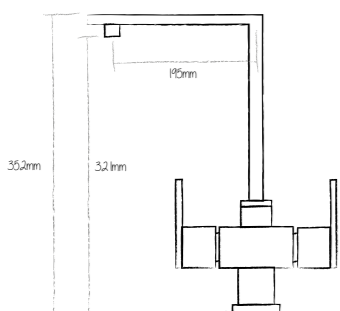

Worktop cut out 35mm required

↔ DIMENSIONS

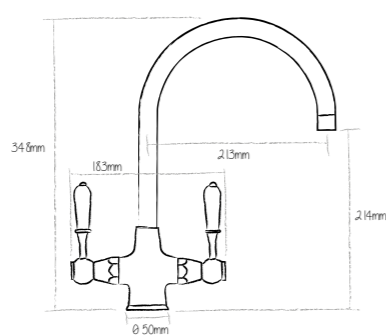

Worktop cut out 35mm required

↔ DIMENSIONS

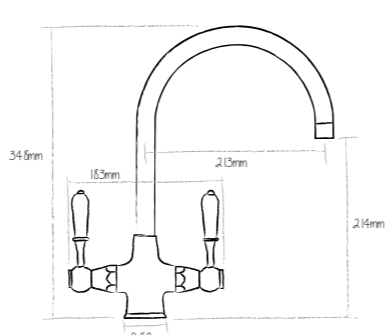

Worktop cut out 35mm required

↔ DIMENSIONS

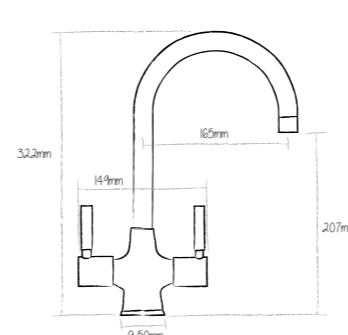

Worktop cut out 35mm required

↔ DIMENSIONS

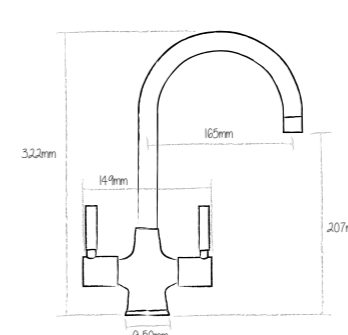

Worktop cut out 35mm required

↔ DIMENSIONS

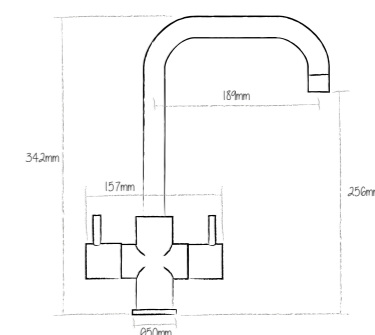

Worktop cut out 35mm required

WASTE DISPOSAL UNITS

A waste disposer hidden away under the sink can help you recycle your food scraps and leftovers like potato peelings, chicken bones, egg shells and tea bags. It's clean, it's green and it leaves you less to clutter up your bin.



Simply turn on the cold tap and the disposer, then empty everything into the sink. The disposer grinds the food waste into fine particles and flushes the waste away down the drain.

Since more than 25% of household refuse is food, that means much less rubbish for the dustmen to take away to clog up our landfill sites, and a reduction in the amount of greenhouse gases emitted.

Disposer waste can be recycled into a soil conditioner once it reaches the water treatment plant so you will be making a positive contribution to your environment.

1.0HP WASTE DISPOSAL UNIT



PRODUCT CODE
WDU100

↔ DIMENSIONS
Width 216mm
Depth 216mm
Height 437mm

- GENERAL FEATURES**
3 YEAR GUARANTEE
- 1.0hp waste disposal unit
 - Continuous feed
 - High speed magnet motor
 - Overload protection
 - Corrosion resistant 3 stage grinding system
 - Easy mount installation
 - Sound insulation
 - Air switch WDUAIR included
 - Removable splash guard
 - Fits standard 90mm waste outlets

ACCESSORY OPTIONS



Basket strainer waste decorative cover CWC2

0.75HP WASTE DISPOSAL UNIT



PRODUCT CODE
WDU075

↔ DIMENSIONS
Width 216mm
Depth 216mm
Height 400mm

- GENERAL FEATURES**
2 YEAR GUARANTEE
- 0.75hp waste disposal unit
 - Continuous feed
 - High speed magnet motor
 - Overload protection
 - Corrosion resistant 3 stage grinding system
 - Easy mount installation
 - Sound insulation
 - Air switch WDUAIR included
 - Removable splash guard
 - Fits standard 90mm waste outlets

ACCESSORY OPTIONS



Basket strainer waste decorative cover CWC2

0.5HP WASTE DISPOSAL UNIT



PRODUCT CODE
WDU050

↔ DIMENSIONS
Width 175mm
Depth 175mm
Height 372mm

- GENERAL FEATURES**
2 YEAR GUARANTEE
- 0.5hp waste disposal unit
 - Continuous feed
 - High speed magnet motor
 - Overload protection
 - Corrosion resistant 3 stage grinding system
 - Easy mount installation
 - Sound insulation
 - Suitable for air switch WDUAIR
 - Removable splash guard
 - Fits standard 90mm waste outlets

ACCESSORY OPTIONS



Basket strainer waste decorative cover CWC2



Chrome air switch is an optional extra with the WDU050. It comes as standard with the WDU075 and WDU100. 35mm cut-out.

WDUAIR

GUARANTEES

For peace of mind, we provide the following guarantees on our sinks, taps and waste disposers.



**FREE
5 YEAR
GUARANTEE**

SINKS 5 YEAR GUARANTEE AGAINST MANUFACTURING DEFECTS

TAPS 5 YEAR GUARANTEE ON COATINGS AND FINISHES
5 YEAR GUARANTEE ON MOVING PARTS AND VALVES
5 YEAR GUARANTEE ON STAINLESS STEEL FINISH

VAPOS BOILER 2 YEAR GUARANTEE

WASTE DISPOSERS 2 YEAR GUARANTEE ON WDU050
2 YEAR GUARANTEE ON WDU075
3 YEAR GUARANTEE ON WDU100

AFTER-SALES CUSTOMER SUPPORT

Year 1-5 Caple – telephone 0117 938 7420

*Calls are charged at the local rate – please check with your provider for actual charges.
Subject to terms and conditions*



Issue: CST0218

Every effort has been made to reproduce colours and materials accurately, however due to the photography and print processes, colour variations may occur.

Due to our continued product development policy, we reserve the right to modify product specifications and/or dimensions without notice.

Please contact your retailer, call Caple direct on 0117 938 1900, email info@caple.co.uk, or visit our website at www.caple.co.uk for further product information.

E & O E