

Lakes
Bathrooms

SUPERIOR AS STANDARD

Escape to our Island

Explore our exclusive
Island Collection
of entirely frameless
enclosures.

See page 96

Shower enclosures,
walk-ins and bath screens

JANUARY 2018

Welcome to Lakes Bathrooms

Of all the rooms in your home, the bathroom should be a space for refreshment and relaxation – a place to invigorate and prepare for the day ahead or to return home, unwind and pamper mind and body.

In our book, this book, that means you and your bathroom deserve the best. Products which will serve you day after day, shower after shower – simple, elegant, practical and faultless.



Tewkesbury Warehouse

It's why we use only the finest materials, and it's why you'll find a lifetime guarantee on shower doors, enclosures and bath screens for domestic application, protecting you against any manufacturing or material defects. If it's our fault we won't quibble and we'll supply any replacement parts totally free of charge.



When we say 'superior as standard', it's a promise that really holds water. Take our AllClear® stay-clean coating, for example. Some other manufacturers offer similar coatings as an expensive extra. We apply it as standard, so you can spend more time enjoying your shower and less time cleaning it.

All our enclosures, doors and bath screens now also feature PureVue^{HD}, our optically clearer glass which costs more than standard glass, but again we offer as standard.

You can read more about these superior as standard benefits on pages 4-7.

Superior as standard

Our name may be unfamiliar to you but we have been a leading manufacturer and supplier of shower enclosures, doors and bath screens to the trade for more than 30 years. We are trusted and recommended by professional stockists and installers who appreciate both the value and values our products represent.



As an independent firm of long standing, quality really does matter to us, in how our enclosures perform and in how we perform supporting our customers.



Quality Craftsmanship

Proud of our independence, family origins and values, we continue to focus on quality and innovation to deliver a unique range of products which are **superior as standard.**



Choose choice

Even with our experience we have never seen two bathrooms that are exactly the same.

Which is why we offer such a wide choice of designs and styles, arranged in three collections, to help you bring your ideas to life from a simple en suite to a designer wet room.

Stay in the flow



We like to stay in touch with our customers and share all things shower (like people's favourite shower songs), so please do hook up to our social channels.

From brochure to shower

If you have come to Lakes through one of our stockist or installer partners we are sure you will be very happy together and they will be pleased to answer any questions you may have.

If you need to find your nearest stockist, or if we can help in any way, by all means call us during office hours on **01684 853870** or visit **www.lakesbathrooms.co.uk**

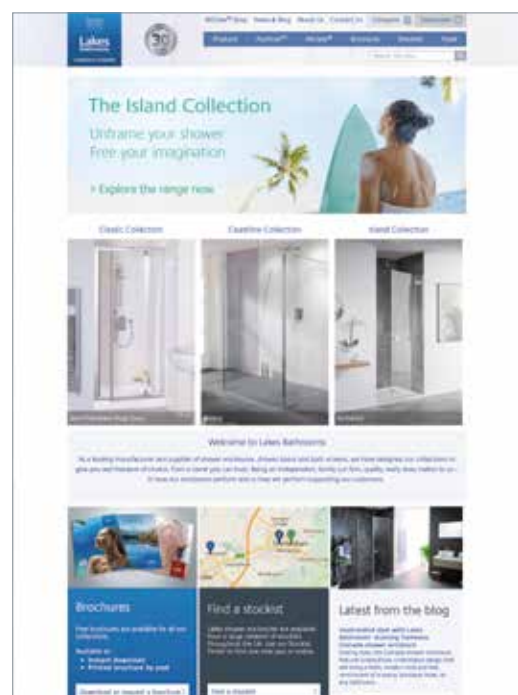



See your bathroom's
true colours through
PureVue^{HD} ultra clear
low-iron glass*

Standard glass
has a green tinge

PureVue^{HD} glass is optically
superior and ultra clear

Brilliantly new. Clearly you

The revolutionary introduction of PureVue^{HD} glass at no extra cost on every single product in our Classic, Coastline and Island Collections brings a clear edge to your bathroom.

PureVue^{HD} is a high quality, optically superior 'low-iron' glass.

In standard glass its iron-oxide content shows itself as a green tinge that's most apparent when you view the edge of the glass, but which also affects and tints everything seen through it.

PureVue^{HD} by comparison is dramatically clearer. The reduced iron content reduces the greenish hue to almost zero levels. Tint free, it enables the natural beauty of anything seen through the glass to shine through.

For the first time it brings to your bathroom the natural colours, sharpness and enhanced clarity that high definition TV brings to your living room.

PureVue^{HD} glass

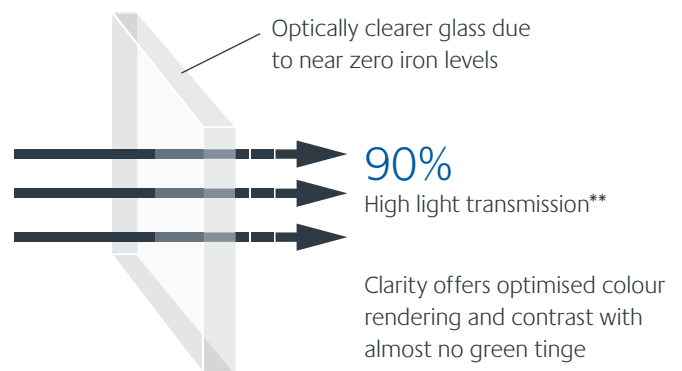

Clearly superior

Very high transmission levels enable as much light as possible to pass through, making everything lighter and brighter.

From your carefully chosen bathroom tiling and décor, to fittings and accessories, you will see a purer vision of everything but the glass, which almost disappears. And the thicker the glass, the stronger the greening effect of iron-oxide becomes, so the greater the difference PureVue^{HD} can make.

Combined with our advanced AllClear coating (see page 6 for details) it gives every Lakes enclosure, walk-in and bath screen a very clear edge.

Standard float glass

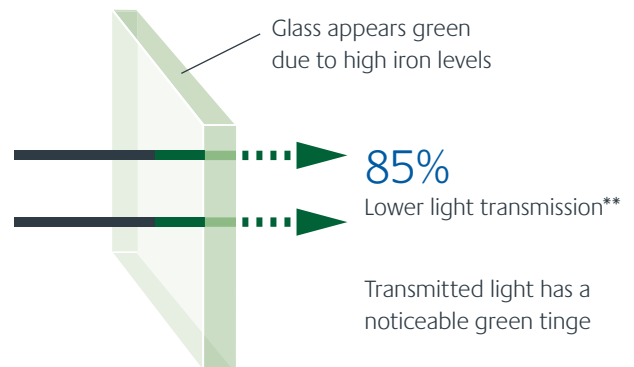

Superior as standard

You might expect such a dramatic advance to cost more, and typically low-iron glass can cost up to 50% more than standard glass.

However, by being true to our promise to offer every customer of Lakes 'superior as standard', and by integrating PureVue^{HD} across the range in our own high efficiency production facility, we are able to bring you this additional clarity without any additional cost.

Exceptionally clear and exceptional value – see your bathroom in its true colours with PureVue^{HD} glass, exclusively from Lakes Bathrooms.



* Excludes Mirror Collection.

** Figures based on typical standard float glass of 10mm thickness.

AllClear®

The eco-friendly stay-clean coating

We believe your shower time should be lavished on you, not be spent cleaning and scrubbing the enclosure.

It's why our AllClear stay-clean coating is standard *on both sides of the glass* on every single product in our Classic, Coastline and Island Collections.

AllClear's advanced technology effectively cleans your shower for you, repelling water, lime scale and soap scum so a quick wipe is all that's needed to keep that 'as new' sparkle, and it's kinder to the environment too.

Watch the movie



We've made a short, informative movie that illustrates just how effective AllClear is, which you can view online at: www.lakesbathrooms.co.uk/allclear



Untreated glass

Treated with AllClear®

Good for you, better for the environment

AllClear is truly eco-friendly. Water sheets off the coated glass, washing away soap scum and grime as it goes, so it's more hygienic. And with less bacteria, there's less need for harsh chemical cleaners, which is kind to the environment and to your pocket.



How does it work?

Look into a microscope and you would see that standard glass actually has a pitted surface to which water, lime scale and soap scum can cling, building up with every shower and requiring regular scrubbing to keep your enclosure clean and hygienic.

Inspired by nature, our AllClear coating forms an invisible, microscopically smooth shield to prevent this build up of grime.

AllClear's hydrophobic properties cause water to run off freely, washing away residue and dirt as it goes.

It's an amazing effect that has to be seen to be believed – one reason why we've produced a demonstration movie so you can see the AllClear magic for yourself.

AllClear protective coating actively repels water and grime to stay looking cleaner for longer.

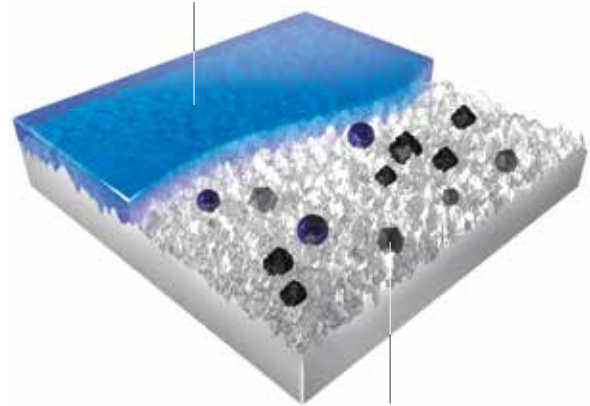

Water and grime cling readily to untreated, uneven glass surface.

Free to enjoy

Some manufacturers charge in excess of £100 to apply similar coatings as an optional extra. Only Lakes brings you the extra benefits of AllClear protection on both sides of the glass at no extra cost. **AllClear is guaranteed to outperform untreated glass for 3 years**, so you're free to enjoy every refreshing minute of showering.

Clearly better

AllClear not only means superior performance, it's a superior product in its own right, proven to outperform other coatings on the market.*

Glass coated with AllClear also has greatly enhanced impact and abrasion resistance and 20% more brilliance.

*Conclusion derived from extensive tests conducted by the Institute for Glass Science and Engineering, New York.

Optimised performance

You can also purchase the 'Surface Protection System' kit in our online shop to help keep your AllClear enclosure performing at its best throughout its guaranteed period:

www.lakesbathrooms.co.uk/allclearsps



Find the one for you



If you've got as far as our brochure, you're probably already juggling all sorts of options from room layouts and shower types to tiles, taps, flooring and furnishing.

Our three Collections are designed to fit with your plans or inspire new ideas – to blend in with other elements or to stand out as the focal point of a bathroom or en suite.



Classic style

From urban chic to Victorian splendour, bathroom design is very much a personal choice.

Our **Classic Collection** of enclosures and screens, available in an anodized silver or clean white finish, have been designed to complement and enhance any space.

Simple, clean lines, smooth running doors, effective seals, functional handles and hinges and a wide choice of styles give you the freedom to create your dream scheme.

Plus of course you have the superior performance of our PureVue^{HD} glass and AllClear coating to enjoy as standard.

See pages 14-59



The natural beauty of Coastline

Sculpted from the strength and simple beauty of 8mm and 10mm toughened safety glass panels, each design in the **Coastline Collection** brings the pleasure of showering to life with a real sense of space.

Subtle variations in size and arrangement mean there's a design to complement most room plans, and each enclosure can be installed as a wet room or accompanied by an elegant low profile shower tray.

With our PureVue^{HD} glass and AllClear coating as standard throughout, Coastline combines chic continental style with easy-clean practicality for a lifetime of showering pleasure.

See pages 60-95



Explore our exclusive Island

Picture yourself barefoot and in the warm embrace of a Caribbean island and you have the inspiration behind our exclusive **Island Collection**.

Capturing the freedom of fresh air showering by the beach, each design is entirely frameless and has been beautifully refined to make the most of the clarity provided by our PureVue^{HD} glass and AllClear[®] coating.

See pages 96-107



MIRROR™

Add a mirrored finish to your enclosure, door or bath screen.

We believe your bathroom should be a reflection of both practicality and style – as easy to live with as it is beautiful to look at. Which is why we are so excited about the development of our innovative Mirror coating. The mirrored-glass finish is available on all our most popular enclosures, doors and bath screens.

Beyond the functionality of a full-length mirror and shielded showering space, the reflective surface creates a sense of contemporary living and the illusion of additional light and space to any bathroom design.

Without the need for additional wall-mounted mirrors, you can free up valuable space and keep your room clean and uncluttered.

All Mirror designs can be found in the Lakes Bathrooms Mirror brochure – available to download at www.lakesbathrooms.co.uk



The illusion of space

Bathrooms are rarely the largest room in the house, which makes the effective use of space even more important. Our Mirror finish not only creates the illusion of space but also frees up actual space, by providing an essential built-in, full-length bathroom mirror that doesn't require a wall.



Additional light

It's important that a bathroom feels light. A mirrored surface helps to spread light further, reflecting any source, to brighten even the smallest of bathroom spaces.



Practical in every aspect

Providing all the advantages of a full-length mirror in a space that can't always accommodate one, the reflective surface is practical not only in its common uses, but also in providing improved privacy.



A lightness of touch

The seamless reflective finish of our Mirror option sits perfectly within the clean lines of our shower enclosures, providing you with more design possibilities in the bathroom.



Classic

The Collection

6mm
& 8mm
Glass

Fully-Framed Shower Enclosures & Doors

Bi-Fold Door	16
Pivot Door	18
Slider Door	20
Corner Entry	22
Pentagon	24

Semi-Frameless Shower Enclosures & Doors

Double Door Quadrant	28
Single Door Quadrant	30
Easy-fit Quadrant	32
Bi-Fold Door	34
Pivot Door	36
Pivot Door with integrated In-line Panel	38
Slider Door	40
Double Slider Door	42
Corner Entry	44
Pentagon	46
Walk In	48
Shower Screen	50
Over Bath Double Slider Door	52

Side Panels & In-Line Panels

Classic Side Panel	56
In-Line Panel Pack	58



14 - 59

Bath Screens

Coastline 8mm Hinged	110
Classic Curved Hinged	112
Classic & Coastline Curved	114
Classic Sculpted	116
Classic & Coastline Square	118
Classic Framed	120
Classic Shower Curtain Panel	122

4, 6 &
8mm
Glass



108 - 123

Coastline

The Collection

8mm &
10mm
Glass

Semi-Frameless Shower Enclosures & Doors

Valmiera Double Door Quadrant	62
Sorong Single Door Quadrant	64
Bergen Bi-Fold Door	66
Narva Pivot Door	68
Talsi Slider Door	70
Malmo Corner Entry	72
Coastline Side Panel	74

Frameless Walk-In Shower Enclosures

Cannes	78
Levanzo	80
Marseilles	82
Nice	84
Palma	86
Andora	88
Rhodes	90
Riviera	92
Alassio	94

60 - 95

Island

Frameless Shower Doors & Enclosures

8mm
Glass

Barbados Hinged Door	98	Martinique Hinged Panel & Door	104
Cayman Hinged Door with In-Line Panel	100	Tobago Hinged Panel, Door & Side Panel	106
Grenada Hinged Door & Side Panel	102		

96 - 107

Specifications

Frames
Safety Glass
Handles
Extension Profiles
Doors and Seals
Additional Strength
Adaptability
Flexibility
Versatility

Shower Trays

Standard Tray Shapes
Easy-Plumb Kits
Special Trays
Tray Prices & Dimensions
Tray Heights
Trays with Upstands
Wastes

Accessories

Shower Seats
Grab Bars & Rails

124 - 137



Clearly
Superior
Glass

See page 4

Fully-Framed Shower Enclosures & Doors

Sleek lines, clever space saving solutions and outstanding value.

6mm
GLASS





Clearly
Superior
Glass

See page 4



Framed Bi-Fold Door

6mm
GLASS

Simple, elegant and practical – the inward opening bi-fold door design is the perfect space saving solution.



Specifications

Standard Sizes (width x height)	Width Adjustment	Door Opening	Order Code <i>Silver</i>	Order Code <i>White</i>
700 x 1850	660 - 720	480	LK1B070 05	LK1B070 30
750 x 1850	720 - 780	540	LK1B075 05	LK1B075 30
800 x 1850	760 - 820	580	LK1B080 05	LK1B080 30
900 x 1850	840 - 900	660	LK1B090 05	LK1B090 30
1000 x 1850	940 - 1000	760	LK1B1000 05	LK1B1000 30

30mm Extension Profile (LEP 05 Silver, LEP 30 White) – see page 127.

Note: Maximum adjustment range is reduced by 15mm when used in conjunction with the In-Line Panel Pack p.59.

Compatible with Classic Side Panel (LK1SP 05 Silver, LK1SP 30 White) – see pages 56-57.

All measurements are in mm

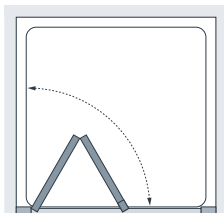



Clearly
Superior
Glass

See page 4



Framed Pivot Door

6mm
GLASS

Perhaps the simplest solution we offer. The practical pivoting door means effortless showering and clean, uncluttered looks.



Specifications

Standard Sizes (width x height)	Width Adjustment	Door Opening	Order Code <i>Silver</i>	Order Code <i>White</i>
700 x 1850	660 - 720	450	LK1P070 05	LK1P070 30
750 x 1850	720 - 780	510	LK1P075 05	LK1P075 30
800 x 1850	760 - 820	490	LK1P080 05	LK1P080 30
900 x 1850	840 - 900	510	LK1P090 05	LK1P090 30
1000 x 1850	940 - 1000	590	LK1P100 05	LK1P100 30

30mm Extension Profile (LEP 05 Silver, LEP 30 White) – see page 127.

Note: Maximum adjustment range is reduced by 15mm when used in conjunction with the In-Line Panel Pack p.59.

Compatible with Classic Side Panel (LK1SP 05 Silver, LK1SP 30 White) – see pages 56-57.

All measurements are in mm

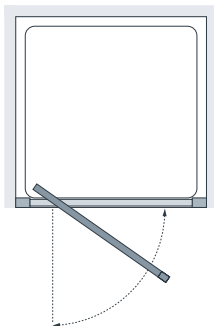



Clearly
Superior
Glass

See page 4



Framed Slider Door

6mm
GLASS

The lightest of touches is all that's needed for the door to glide back, enabling you to step in and enjoy a light and spacious shower.



Specifications

Standard Sizes (width x height)	Width Adjustment	Door Opening	Order Code <i>Silver</i>	Order Code <i>White</i>
1000 x 1850	940 - 1000	380	LK12S100 05	LK12S100 30
1100 x 1850	1040 - 1100	430	LK12S110 05	LK12S110 30
1200 x 1850	1140 - 1200	480	LK12S120 05	LK12S120 30

30mm Extension Profile (LEP 05 Silver, LEP 30 White) – see page 127.

Note: Maximum adjustment range is reduced by 15mm when used in conjunction with the In-Line Panel Pack p.59.

Compatible with Classic Side Panel (LK1SP 05 Silver, LK1SP 30 White) – see pages 56-57.

All measurements are in mm

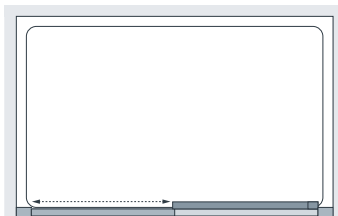



Clearly
Superior
Glass

See page 4

Framed Corner Entry

A great self-contained design featuring sliding doors to each side of the enclosure and combining quality and practicality in one elegant solution.



Specifications

Standard Sizes (width x height)	Width Adjustment	Door Opening	Order Code <i>Silver</i>	Order Code <i>White</i>
750 x 1850	710 - 740	390	LK1C075 05	LK1C075 30
800 x 1850	750 - 780	420	LK1C080 05	LK1C080 30
900 x 1850	850 - 880	490	LK1C090 05	LK1C090 30

30mm Extension Profile (LEP 05 Silver, LEP 30 White) – see page 127.

Compatible with Classic Side Panel (LK1SP 05 Silver, LK1SP 30 White) – see pages 56-57.

All measurements are in mm

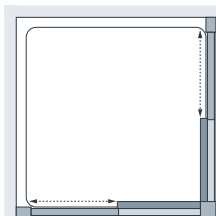



Clearly
Superior
Glass

See page 4

Framed Pentagon

6mm
GLASS

Bold lines and a striking shape make our Pentagon enclosure a distinctive choice with the freedom to add a pivoting door or, as shown, a bi-fold design.



Specifications

	Standard Sizes (width x height)	Width Adjustment	Door Opening	Order Code <i>Silver</i>	Order Code <i>White</i>
Pentagon Side Panels	350 x 1850	340 - 400	n/a	LPE34-40 05	LPE34-40 30
Framed Bi-Fold Door	700 x 1850	660 - 720	480	LK1B070 05	LK1B070 30
Framed Pivot Door	700 x 1850	660 - 720	450	LK1P070 05	LK1P070 30

	Standard Size	Tray Type	Product Code
Pentagon Tray complete with 90mm waste	900 x 900	Low-Profile ABS Resin	TP99-ENG

All measurements are in mm

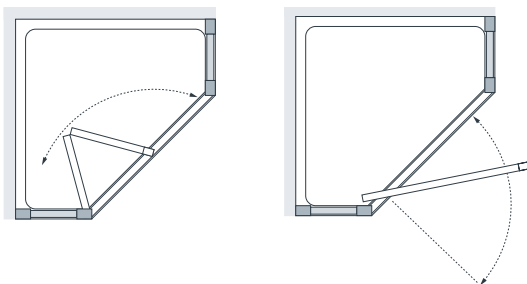



Semi-Frameless Shower Enclosures & Doors

Slimmer profiles and elegant design details create a more contemporary look.



Clearly
Superior
Glass

See page 4

Classic Collection

6mm &
8mm
GLASS





Clearly
Superior
Glass

See page 4

Double Door Quadrant

Designed with affordability in mind, the handsome curves of this corner design and spacious offset option are complemented by a subtly rounded profile.



Specifications (Quadrant)

Standard Sizes (width x height)	Width Adjustment	Door Opening	Order Code Silver
800 x 1850	765 - 795	370	LKV2R800 05
900 x 1850	865 - 895	530	LKV2R900 05
1000 x 1850	965 - 995	530	LKV2R1000 05

Specifications (Offset Quadrant)

900 x 800 x 1850	865-895 x 765-795	450	LKV2R900800 05
1000 x 800 x 1850	965-995 x 765-795	450	LKV2R1000800 05
1200 x 800 x 1850	1165-1195 x 765-795	450	LKV2R1200800 05
1200 x 900 x 1850	1165-1195 x 865-895	530	LKV2R1200900 05

30mm Extension Profile (LEP 05 Silver) – see page 127.

Alternative Bright Chrome Plate Finish Stainless Steel Loop Handle (SK-130) – see page 126.

Compatible with Classic Side Panel (LK1SP 05 Silver, LK1SP 30 White) – see pages 56-57.

All measurements are in mm

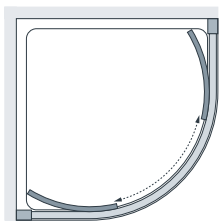

Double Door Quadrant

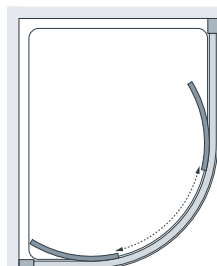

Offset Left-Hand Tray

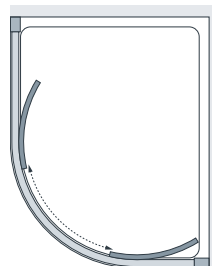

Offset Right-Hand Tray



Alternative Chrome Plate Stainless Steel Loop Handle



Pure
Vue^{HD}

Clearly
Superior
Glass

See page 4

Single Door Quadrant

6mm
GLASS

A more elegant and practical solution to the typical double-door design.



Specifications (Quadrant)

Standard Sizes (width x height)	Width Adjustment	Door Opening	Order Code Silver
800 x 1900	765 - 795	400	SDV2R080 05
900 x 1900	865 - 895	500	SDV2R090 05
1000 x 1900	965 - 995	500	SDV2R100 05

Specifications (Offset Quadrant)

900 x 760 x 1900	865-895 x 725-755	500	SDV2R0976 05
900 x 800 x 1900	865-895 x 765-795	500	SDV2R098 05
1000 x 800 x 1900	965-995 x 765-795	500	SDV2R108 05
1200 x 800 x 1900	1165-1195 x 765-795	500	SDV2R128 05
1200 x 900 x 1900	1165-1195 x 865-895	500	SDV2R129 05

Note: Door closure is to 'flat' fixed panel only.

Alternative Bright Chrome Plate Finish Stainless Steel Loop Handle (SK-130) – see page 126.

All measurements are in mm

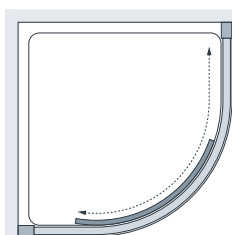

Single Door Quadrant

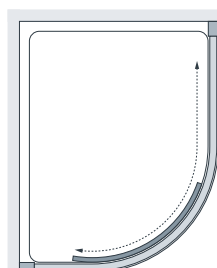

Offset Left-Hand Tray

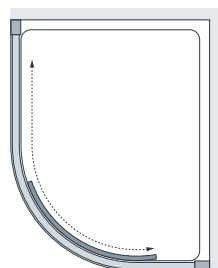

Offset Right-Hand Tray



Alternative Chrome Plate Stainless
Steel Loop Handle



Clearly
Superior
Glass

See page 4

Easy-fit Quadrant

6mm
GLASS

Our original quadrant design is precision engineered to enable easier installation and makes great use of the available space in any bathroom.



Specifications (Quadrant)

Standard Sizes (width x height)	Width Adjustment	Door Opening	Order Code Silver	Order Code White
800 x 1850	765 - 790	370	LKR800 05	LKR800 30
900 x 1850	865 - 890	530	LKR900 05	LKR900 30
1000 x 1850	965 - 990	530	LKR1000 05	LKR1000 30

Specifications (Offset Quadrant)

900 x 800 x 1850	865-890 x 765-790	450	LKR900800 05	LKR900800 30
1000 x 800 x 1850	965-990 x 765-790	450	LKR1000800 05	LKR1000800 30
1200 x 800 x 1850	1165-1190 x 765-790	450	LKR1200800 05	LKR1200800 30
1200 x 900 x 1850	1165-1190 x 865-890	530	LKR1200900 05	LKR1200900 30

30mm Quadrant Extension Profile (LKR-C001 Silver, LKR-W001 White) – see page 127.

Special height 1750mm doors are available upon request.

Alternative Bright Chrome Plate Finish Stainless Steel Loop Handle (SK-130) – see page 126.

All measurements are in mm

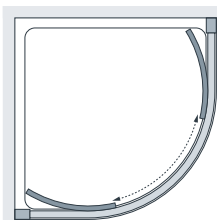

Easy-fit Quadrant

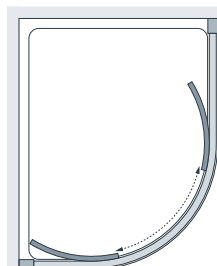

Offset Left-Hand Tray

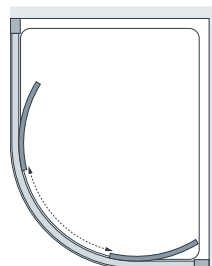

Offset Right-Hand Tray



Alternative Chrome Plate Stainless Steel Loop Handle



Clearly
Superior
Glass

See page 4



Semi-Frameless Bi-Fold Door

6mm
GLASS

Where space is at a premium this simple design provides a stylish solution, complete with an attractive handle detail.



Specifications

Standard Sizes (width x height)	Width Adjustment	Door Opening	Order Code <i>Silver</i>	Order Code <i>White</i>
700 x 1850	660 - 720	425	LKVB070 05	LKVB070 30
750 x 1850	720 - 780	485	LKVB075 05	LKVB075 30
800 x 1850	760 - 820	525	LKVB080 05	LKVB080 30
900 x 1850	840 - 900	605	LKVB090 05	LKVB090 30
1000 x 1850	940 - 1000	705	LKVB1000 05	LKVB1000 30

30mm Extension Profile (LEP 05 Silver, LEP 30 White) – see page 127.

Note: Maximum adjustment range is reduced by 15mm when used in conjunction with the In-Line Panel Pack p.59.

Special height 1750mm doors are available upon request.

Compatible with Classic Side Panel (LK1SP 05 Silver, LK1SP 30 White) – see pages 56-57.

All measurements are in mm

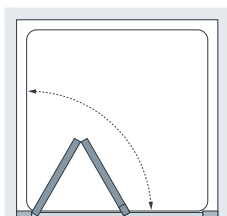



Clearly
Superior
Glass

See page 4

Semi-Frameless Pivot Door

Deceptively simple yet simply stunning. The semi-frameless door creates a particularly slim profile to complement the simplicity of many modern suites.



Specifications

Standard Sizes (width x height)	Width Adjustment	Door Opening	Order Code <i>Silver</i>	Order Code <i>White</i>
700 x 1850	660 - 720	420	LKVP070 05	LKVP070 30
750 x 1850	720 - 780	480	LKVP075 05	LKVP075 30
800 x 1850	760 - 820	500	LKVP080 05	LKVP080 30
900 x 1850	840 - 900	550	LKVP090 05	LKVP090 30
1000 x 1850	940 - 1000	590	LKVP100 05	LKVP100 30

30mm Extension Profile (LEP 05 Silver, LEP 30 White) – see page 127.

Note: Maximum adjustment range is reduced by 15mm when used in conjunction with the In-Line Panel Pack p.59.

Special height 1750mm doors are available upon request.

Alternative Bright Chrome Plate Finish Stainless Steel Loop Handle (SK-130) – see page 126.

Compatible with Classic Side Panel (LK1SP 05 Silver, LK1SP 30 White) – see pages 56-57.

All measurements are in mm

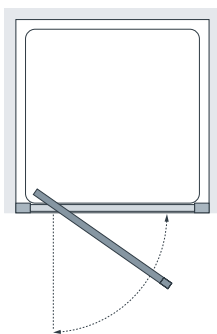

Alternative Chrome Plate Stainless Steel Loop Handle



Pure
Vue^{HD}

Clearly
Superior
Glass

See page 4

Semi-Frameless Pivot Door with integrated In-line Panel

A seamless finish for a wider enclosure, with no profile between the door and the adjacent in-line panel.



Specifications

Standard Sizes (width x height)	Width Adjustment	In-Line Panel	Wall to door – at 90° open (A)	Door Opening	Order Code <i>Silver</i>
1000 x 1850	940 - 1000	149	315 - 345	555	LKVPI100 05
1100 x 1850	1040 - 1100	249	415 - 445	555	LKVPI110 05
1200 x 1850	1140 - 1200	349	515 - 545	555	LKVPI120 05

30mm Extension Profile (LEP 05 Silver) – see page 127.

Alternative Bright Chrome Plate Finish Stainless Steel Loop Handle (SK-130) – see page 126.

Compatible with Classic Side Panel (LK1SP 05 Silver, LK1SP 30 White) – see pages 56-57.

All measurements are in mm

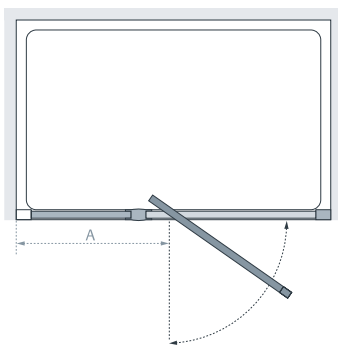

*Alternative Chrome Plate Stainless
Steel Loop Handle*



Pure
Vue^{HD}

Clearly
Superior
Glass

See page 4

Semi-Frameless Slider Door

6mm
GLASS

With a choice of sizes from 1000mm to 2000mm you have the freedom to create the perfect showering area for your bathroom.



Specifications

Standard Sizes (width x height)	Width Adjustment	Door Opening	Order Code Silver	Order Code White
1000 x 1850	940 - 1000	360	LKV2S100 05	LKV2S100 30
1100 x 1850	1040 - 1100	410	LKV2S110 05	LKV2S110 30
1200 x 1850	1140 - 1200	460	LKV2S120 05	LKV2S120 30
1300 x 1850	1240 - 1300	510	LKV2S130 05	n/a
1400 x 1850	1340 - 1400	560	LKV2S140 05	LKV2S140 30
1500 x 1850	1440 - 1500	610	LKV2S150 05	LKV2S150 30
1600 x 1850	1540 - 1600	660	LKV2S160 05	LKV2S160 30
1700 x 1850	1640 - 1700	710	LKV2S170 05	LKV2S170 30
1800 x 1850	1740 - 1800	760	LKV2S180 05	n/a
2000 x 1850	1940 - 2000	910	LKV2S200 05	n/a

30mm Extension Profile (LEP 05 Silver, LEP 30 White) – see page 127.

Note: Maximum adjustment range is reduced by 15mm when used in conjunction with the In-Line Panel Pack p.59.

Special height 1750mm doors are available upon request.

Alternative Bright Chrome Plate Finish Stainless Steel Loop Handle (SK-130) – see page 126.

Compatible with Classic Side Panel (LK1SP 05 Silver, LK1SP 30 White) – see pages 56-57.

All measurements are in mm

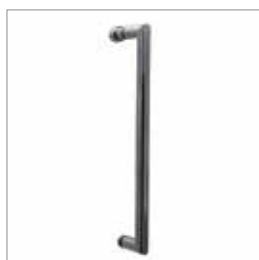
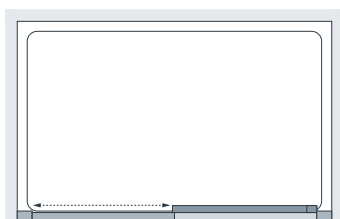

Alternative Chrome Plate Stainless
Steel Loop Handle



Clearly
Superior
Glass

See page 4

Semi-Frameless Double Slider Door

6mm
GLASS

Sleek and practical, the smooth running double door design offers easy access to the enclosure.



*Semi-Frameless Double Slider Door
with Classic Side Panel*

Specifications

Standard Sizes (width x height)	Width Adjustment	Door Opening	Order Code Silver
1200 x 1850	1140 - 1200	430	LKV2DS120 05
1400 x 1850	1340 - 1400	530	LKV2DS140 05
1500 x 1850	1440 - 1500	580	LKV2DS150 05
1600 x 1850	1540 - 1600	630	LKV2DS160 05
1700 x 1850	1640 - 1700	680	LKV2DS170 05
1800 x 1850	1740 - 1800	730	LKV2DS180 05
2000 x 1850	1940 - 2000	830	LKV2DS200 05

30mm Extension Profile (LEP 05 Silver) – see page 127.

Alternative Bright Chrome Plate Finish Stainless Steel Loop Handle (SK-130) – see page 126.

Compatible with Classic Side Panel (LK1SP 05 Silver, LK1SP 30 White) – see pages 56-57.

All measurements are in mm

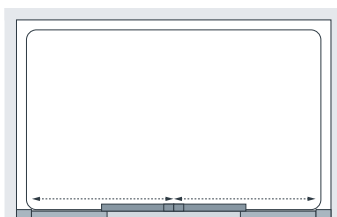

*Alternative Chrome Plate Stainless
Steel Loop Handle*



Clearly
Superior
Glass

See page 4

Semi-Frameless Corner Entry

6mm
GLASS

Slide back the doors on their easy glide system, step in, engage the magnetic door sealing and enjoy an invigorating shower.



Specifications

Standard Sizes (width x height)	Width Adjustment	Door Opening	Order Code <i>Silver</i>	Order Code <i>White</i>
750 x 1850	710 - 740	360	LKVC075 05	LKVC075 30
800 x 1850	750 - 780	385	LKVC080 05	LKVC080 30
900 x 1850	850 - 880	460	LKVC090 05	LKVC090 30
1000 x 1850	950 - 980	530	LKVC100 05	LKVC100 30

30mm Extension Profile (LEP 05 Silver, LEP 30 White) – see page 127.

Special height 1750mm doors are available upon request.

Alternative Bright Chrome Plate Finish Stainless Steel Loop Handle (SK-130) – see page 126.

Compatible with Classic Side Panel (LK1SP 05 Silver, LK1SP 30 White) – see pages 56-57.

All measurements are in mm

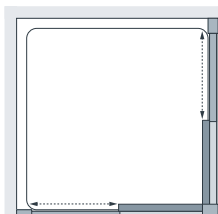

Alternative Chrome Plate Stainless
Steel Loop Handle



Pure
Vue^{HD}

Clearly
Superior
Glass

See page 4

Semi-Frameless Pentagon

6mm
GLASS

Great for situations where space might prevent using a conventional corner unit the practical Pentagon can be fitted with your choice of bi-folding or pivoting door.



Specifications

	Standard Sizes (width x height)	Width Adjustment	Door Opening	Order Code <i>Silver</i>	Order Code <i>White</i>
Pentagon Side Panels	350 x 1850	340 - 400	n/a	LPE34-40 05	LPE34-40 30
Semi-Frameless Bi-Fold Door	700 x 1850	660 - 720	425	LKVB070 05	LKVB070 30
Semi-Frameless Pivot Door	700 x 1850	660 - 720	420	LKVP070 05	LKVP070 30

	Standard Size	Tray Type	Order Code
Pentagon Tray complete with 90mm waste	900 x 900	Low-Profile ABS Resin	TP99-ENG

All measurements are in mm

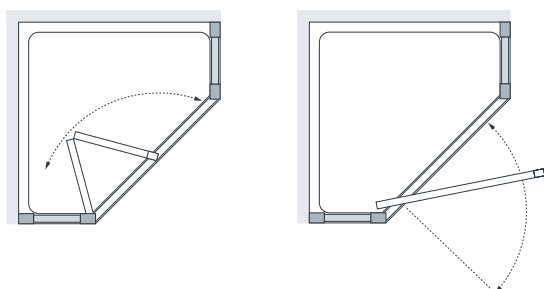



 Clearly Superior Glass
 See page 4

LWS1400 05 Silver Walk In enclosure with additional Side (LWSP080 05) and Return Panels (LWRP080 05)



Walk In enclosure with Front Panel only



Walk In enclosure with additional Side Panel



Walk In

6mm
GLASS

There's an undoubted touch of luxury and indulgence in being able to just step into your shower – a feeling of freedom enhanced by the floating glass screen. With the addition of the optional Side and Return Panels the versatile Walk In creates the perfect shower space.

Specifications

Front Panel (A)	Standard Sizes (width x height)	Width Adjustment	Recommended Tray Size		Order Code Silver
			Min	Max [†]	
	1000 x 1850 + 85	1000 - 1025	1200	1600	LWS1000 05
	1200 x 1850 + 85	1200 - 1225	1400	1800	LWS1200 05
	1400 x 1850 + 85	1400 - 1425	1600	2000	LWS1400 05

Side Panel (B)	700 x 1850 + 85	675 - 700	675	700	LWSP070 05
	750 x 1850 + 85	725 - 750	725	750	LWSP075 05
	800 x 1850 + 85	775 - 800	775	800	LWSP080 05
	900 x 1850 + 85	875 - 900	875	900	LWSP090 05
	1000 x 1850 + 85	975 - 1000	975	1000	LWSP100 05

Return Panel (C)	700 x 1850	660 - 720			LWRP070 05
	750 x 1850	720 - 780			LWRP075 05
	800 x 1850	760 - 820			LWRP080 05
	900 x 1850	840 - 900			LWRP090 05
	1000 x 1850	940 - 1000			LWRP100 05

[†] Max. tray size only applicable when using Side Panel. Size is unrestricted when using Front Panel only. Optional ceiling brace kit (LKSS-C150 Silver). Contact Lakes Bathrooms for advice. All measurements are in mm

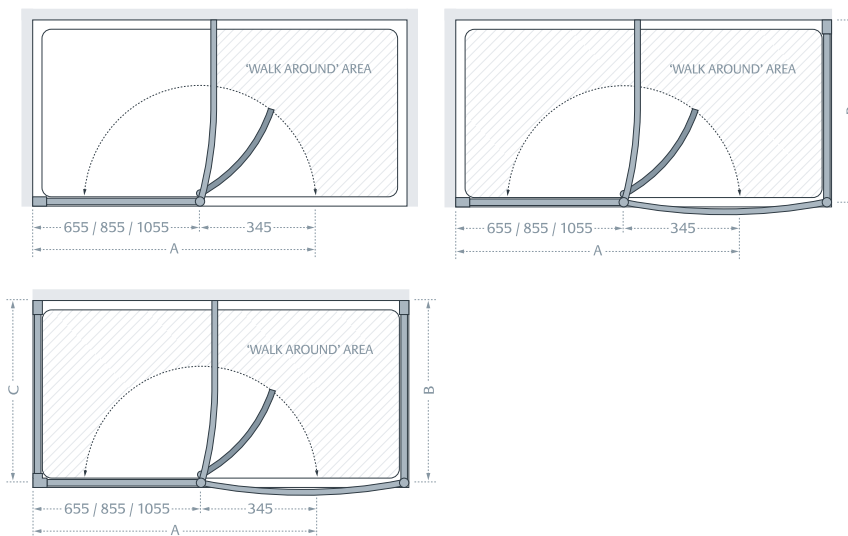

Ceiling Bracing Kit LKSS-C150. Can only be used at the final points.

Careful consideration should be exercised if using a 700mm width tray as 'walk around' sizes may be restrictive.



Clearly
Superior
Glass

See page 4



Shower Screen

8mm
GLASS

The ultimate in shower chic – one striking AllClear® treated glass panel edged by an elegantly turned profile. Pure style, pure bliss.



Specifications (8mm glass)

Standard Sizes (width x height)	Width Adjustment	Order Code <i>Silver</i>
700 x 1900 + 85	675 - 700	LKSS700 05
800 x 1900 + 85	775 - 800	LKSS800 05
900 x 1900 + 85	875 - 900	LKSS900 05
1000 x 1900 + 85	975 - 1000	LKSS1000 05
1200 x 1900 + 85	1175 - 1200	LKSS1200 05

Optional Fixings:
 Ceiling brace kit (LKSS-C150 Silver).
 Extended bracing bar 1200mm in length (LKSS-C021 Silver).
 Contact Lakes Bathrooms for advice.
 All measurements are in mm

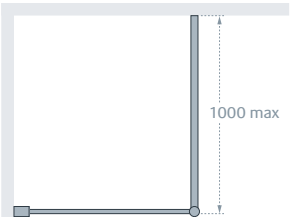

Ceiling Bracing Kit LKSS-C150.
 Can only be used at the
 final points.



Clearly
Superior
Glass

See page 4

Over Bath Semi-Frameless Double Slider Door

An elegant solution where space is at a premium but you still want to be able to choose between the pleasures of bathing or a real showering experience.



*Over Bath Semi-Frameless Double
Slider Door with Side Panel*

Specifications

Door	Standard Sizes (width x height)	Width Adjustment	Door Opening	Order Code Silver
	1500 x 1500	1440 - 1500	580	LKV2BS150 05
	1600 x 1500	1540 - 1600	630	LKV2BS160 05
	1700 x 1500	1640 - 1700	680	LKV2BS170 05
	1800 x 1500	1740 - 1800	730	LKV2BS180 05

Side Panel	Standard Sizes (width x height)	Width Adjustment	Order Code Silver
	700 x 1500	640 - 700	LKV2BSP070 05
	750 x 1500	690 - 750	LKV2BSP075 05
	800 x 1500	740 - 800	LKV2BSP080 05

30mm Extension Profile (LEP 05 Silver) – see page 127.

Alternative Bright Chrome Plate Finish Stainless Steel Loop Handle (SK-130) – see page 126.

All measurements are in mm

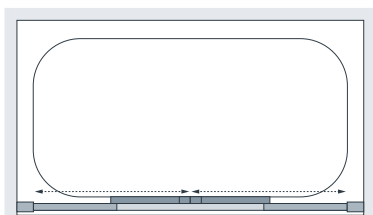

*Alternative Chrome Plate Stainless
Steel Loop Handle*

A man in a white shirt is shown from the chest up, looking towards a blue shower panel. The background is a blurred bathroom setting.

Side Panels & In-Line Panels

Match your shower design to the bathroom of your dreams with the versatile addition of our AllClear® coated side and in-line panels.



Clearly
Superior
Glass

See page 4





Clearly
Superior
Glass

See page 4



Classic Side Panel

6mm
GLASS

Choose the shower door that suits the size and style of your bathroom and add a matching Side Panel to create your perfectly proportioned enclosure.



Specifications

Standard Sizes (width x height)	Width Adjustment	Order Code Silver	Order Code White
700 x 1850	660 - 720	LK1SP070 05	LK1SP070 30
750 x 1850	720 - 780	LK1SP075 05	LK1SP075 30
800 x 1850	760 - 820	LK1SP080 05	LK1SP080 30
900 x 1850	840 - 900	LK1SP090 05	LK1SP090 30
1000 x 1850	940 - 1000	LK1SP1000 05	LK1SP1000 30
1100 x 1850	1040 - 1100	LK1SP1100 05	n/a
1200 x 1850	1140 - 1200	LK1SP1200 05	n/a

Special height 1750mm doors are available upon request.
All measurements are in mm

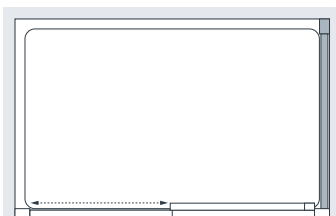

These Side Panels are available exclusively for use with specific Classic Collection products. The panel is compatible with these models:

Code	Page	Code	Page	Code	Page
LK1B	16-17	LKV2R	28-29	LKV2S	40-41
LK1P	18-19	LKVB	34-35	LKV2DS	42-43
LK12S	20-21	LKVP	36-37	LKVC	44-45
LK1C	22-23	LKVPI	38-39	LILPP	58-59



Clearly
Superior
Glass

See page 4



In-Line Panel Pack

Our In-Line Panel Pack contains all you need to create a luxuriously sized enclosure. The pack includes a panel, joining profile and bracing arm.



Specifications

	Standard Size (width x height)	Width Adjustment	Order Code Silver	Order Code White
In-Line Panel Pack	350 x 1850	340 - 385	LILPP350 05	LILPP350 30
In-Line Profile only			LIP-C004	LIP-W004
In-Line Bracing Arm only			BA-C350	BA-W350

Compatible with Classic Side Panel (LK1SP 05 Silver, LK1SP 30 White) – see pages 56-57.
All measurements are in mm

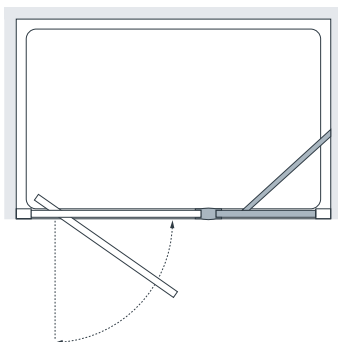

This In-Line Panel Pack is available exclusively for use with the Classic Collection Framed and Semi-Frameless Bi-Fold, Pivot and Slider Doors.

Semi-Frameless Shower Enclosures & Doors

The latest addition to the hugely successful 8mm Coastline Collection, reflecting the richly sleek designs of the entire collection; The Semi-Frameless range provides seamlessly engineered AllClear[®] coated glass panels, with an increased illusion of light and space.



Clearly
Superior
Glass

See page 4



Coastline Collection

8mm
GLASS



Clearly
Superior
Glass

See page 4

Valmiera

8mm
GLASS

Our Coastline Quadrant and Offset Quadrant design is the perfect blend of functionality and the beauty of seamless curves to make the most of aesthetics and available space.



Specifications: Quadrant *(You must order BOTH product codes for your chosen size)*

Standard Sizes <i>(width x height)</i>	Width Adjustment	Door Opening	Order Codes
800 x 2000	765 - 795	390	1 x 8HR080 05 & 1 x 8HRDG
900 x 2000	865 - 895	550	1 x 8HR090 05 & 1 x 8HRDG
1000 x 2000	965 - 995	550	1 x 8HR100 05 & 1 x 8HRDG

Specifications: Offset Quadrant *(You must order BOTH product codes for your chosen size)*

Standard Sizes <i>(w x d x h)</i>	Width Adjustment	Door Opening	Order Codes
900 x 800 x 2000	865-895 & 765-795	470	1 x 8HR098 05 & 1 x 8HRDG
1000 x 800 x 2000	965-995 & 765-795	470	1 x 8HR108 05 & 1 x 8HRDG
1200 x 800 x 2000	1165-1195 & 765-795	470	1 x 8HR128 05 & 1 x 8HRDG
1200 x 900 x 2000	1165-1195 & 865-895	550	1 x 8HR129 05 & 1 x 8HRDG

20mm Extension Profile (8HLEP 05 Silver) – see page 127.
All measurements are in mm

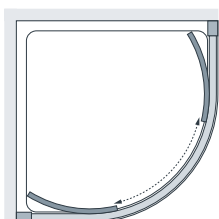

Quadrant

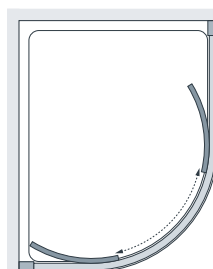

Offset Left-Hand Tray

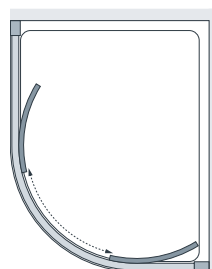

Offset Right-Hand Tray



Clearly Superior Glass

See page 4

Sorong

8mm
GLASS

As a pure quadrant or offset, the single-door Sorong is a harmonious blend of clean lines and gentle curves.

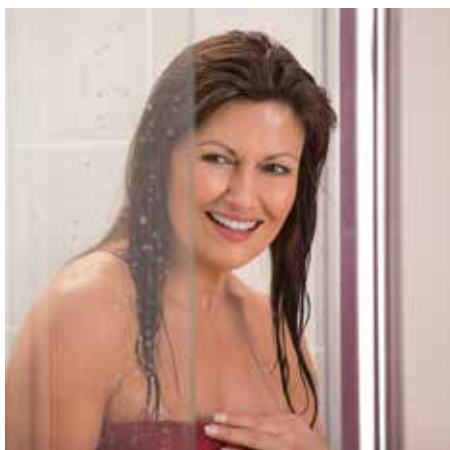

Specifications: Quadrant (You must order BOTH product codes for your chosen size)

Standard Sizes (width x height)	Width Adjustment	Door Opening	Order Codes
800 x 2000	765 - 795	400	1 x 8HRSD080 05 & 1 x 8HRSDDG
900 x 2000	865 - 895	500	1 x 8HRSD090 05 & 1 x 8HRSDDG
1000 x 2000	965 - 995	500	1 x 8HRSD100 05 & 1 x 8HRSDDG

Specifications: Offset Quadrant (You must order BOTH product codes for your chosen size)

Standard Sizes (w x d x h)	Width Adjustment	Door Opening	Order Codes
900 x 760 x 2000	865-895 & 725-755	500	1 x 8HRSD0976 05 & 1 x 8HRSDDG
900 x 800 x 2000	865-895 & 765-795	500	1 x 8HRSD098 05 & 1 x 8HRSDDG
1000 x 800 x 2000	965-995 & 765-795	500	1 x 8HRSD108 05 & 1 x 8HRSDDG
1200 x 800 x 2000	1165-1195 & 765-795	500	1 x 8HRSD128 05 & 1 x 8HRSDDG
1200 x 900 x 2000	1165-1195 & 865-895	500	1 x 8HRSD129 05 & 1 x 8HRSDDG

20mm Extension Profile (8HLEP 05 Silver) – see page 127.
All measurements are in mm

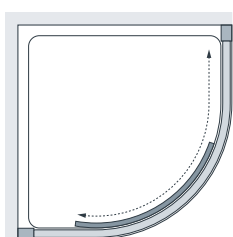

Single Door Quadrant

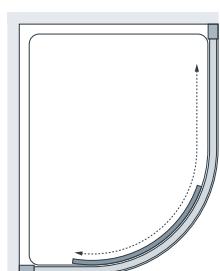

Offset Left-Hand Tray

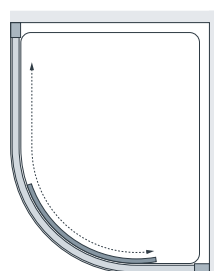

Offset Right-Hand Tray



Clearly
Superior
Glass

See page 4

Bergen

8mm
GLASS

Where space is at a premium, our Coastline Bi-Fold design enhances the illusion of space, without sacrificing elegance or style. Whether in an alcove or corner, they provide a sophisticated design solution.



Specifications

Standard Sizes (width x height)	Width Adjustment	Door Opening	Order Code
700 x 2000	660 - 720	390	8HB070 05
750 x 2000	720 - 780	450	8HB075 05
800 x 2000	760 - 820	490	8HB080 05
900 x 2000	840 - 900	570	8HB090 05
1000 x 2000	940 - 1000	670	8HB100 05

20mm Extension Profile (8HLEP 05 Silver) – see page 127.
Compatible with Coastline Side Panel – see page 75.

All measurements are in mm

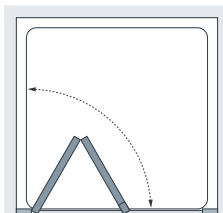



Pure
Vue^{HD}
Clearly
Superior
Glass

See page 4

Narva

8mm
GLASS

Whether combined with a side panel, or installed in an alcove, the slim profile of the Coastline Pivot design is the perfect evocation of sleek style.



Specifications

Standard Sizes (width x height)	Width Adjustment	Door Opening	Order Code
700 x 2000	660 - 720	423	8HP070 05
750 x 2000	720 - 780	483	8HP075 05
800 x 2000	760 - 820	513	8HP080 05
900 x 2000	840 - 900	553	8HP090 05
1000 x 2000	940 - 1000	603	8HP100 05

20mm Extension Profile (8HLEP 05 Silver) – see page 127.
Compatible with Coastline Side Panel – see page 75.

All measurements are in mm

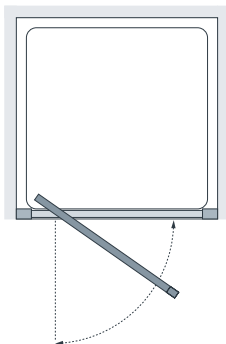



Pure
Vue^{HD}
Clearly
Superior
Glass

See page 4

Talsi

8mm
GLASS

Smooth in style and motion, the fluid nature of our Coastline Slider design perfectly embodies the versatility and design possibilities of this Coastline range. Practical in use and captivating to behold.



Specifications *(You must order BOTH product codes for your chosen size)*

Standard Sizes <i>(width x height)</i>	Width Adjustment	Door Opening	Order Codes
1000 x 2000	940 - 1000	360	1 x 8HS100 05 & 1 x 8HS100DG
1100 x 2000	1040 - 1100	410	1 x 8HS110 05 & 1 x 8HS110DG
1200 x 2000	1140 - 1200	460	1 x 8HS120 05 & 1 x 8HS120DG
1400 x 2000	1340 - 1400	560	1 x 8HS140 05 & 1 x 8HS140DG
1500 x 2000	1440 - 1500	610	1 x 8HS150 05 & 1 x 8HS150DG
1600 x 2000	1540 - 1600	660	1 x 8HS160 05 & 1 x 8HS160DG
1700 x 2000	1640 - 1700	710	1 x 8HS170 05 & 1 x 8HS170DG

20mm Extension Profile (8HLEP 05 Silver) – see page 127.
Compatible with Coastline Side Panel – see page 75.

All measurements are in mm

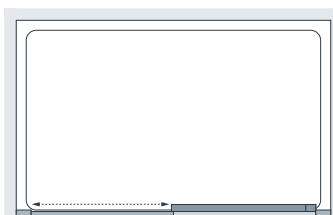



Clearly
Superior
Glass

See page 4

Malmo

8mm
GLASS

Our Coastline Corner Entry design adds another perspective to the chic Coastline Collection. Mix and match from the panel sizes to create your perfectly proportioned enclosure.

Specifications

Standard Sizes (width x height)	Width Adjustment	Order Code
700 x 2000	660 - 690	8HC070 05
750 x 2000	710 - 740	8HC075 05
800 x 2000	750 - 780	8HC080 05
900 x 2000	850 - 880	8HC090 05
1000 x 2000	950 - 980	8HC100 05

IMPORTANT: You must order any TWO product codes to create your chosen enclosure. See example orders below:

Enclosure Size (width x depth)	Door Opening Size	Order Codes
700 x 1000	See table below ^A	8HC070 05 & 8HC100 05
800 x 800	See table below ^B	8HC080 05 & 8HC080 05

Door opening sizes

Panel Size	700	750	800	900	1000
700	330	345	360	400	442
750	345	365	385	423	463
800	360	385	395 ^B	436	475
900	400	423	436	465	506
1000	442 ^A	463	475	506	535

20mm Extension Profile (8HLEP 05 Silver) – see page 127.
All measurements are in mm

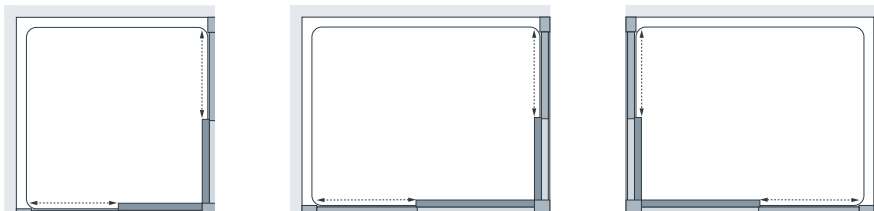



Pure
Vue^{HD} Clearly
Superior
Glass

See page 4

Coastline Side Panel

A simple, yet beautifully designed panel that complements our Coastline Collection doors, making your bathroom vision a reality, no matter what the plan or dimensions of your space.



Specifications (6mm glass)

Standard Sizes (width x height)	Width Adjustment	Order Code
700 x 2000	670 - 700	8HSP070 05
750 x 2000	720 - 750	8HSP075 05
800 x 2000	770 - 800	8HSP080 05
900 x 2000	870 - 900	8HSP090 05
1000 x 2000	970 - 1000	8HSP100 05

20mm Extension Profile (8HLEP 05 Silver) – see page 127.
All measurements are in mm

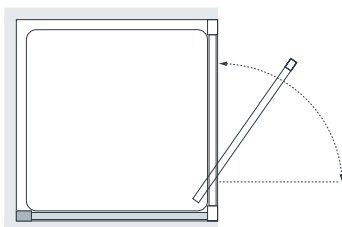

These side panels are available exclusively for use with the Coastline Collection Semi-Frameless doors. The panel is compatible with these models:

Code	Page	Code	Page	Code	Page
8HB	66-67	8HP	68-69	8HS	70-71



Clearly
Superior
Glass

See page 4



Frameless Walk-In Shower Enclosures

The ultimate in sumptuous simplicity. Breathe light into your bathroom with these creative combinations of our 8mm and 10mm AllClear® coated glass panels, each of which can be twinned with a shower tray or wetroom design.



Pure
Vue^{HD}

Clearly
Superior
Glass

See page 4

Cannes

8mm &
10mm
GLASS

Let the beauty of your bathroom décor shine through with the pared-down luxury of our simple Cannes screen.

Shower Panel (A) & Optional Side Panel (B)

Standard Sizes (A / B x height)	Width Adjustment	Order Code
200 x 2000*	200 - 215	LK810-020 05
320 x 2000*	320 - 335	LK810-032 05
400 x 2000*	395 - 410	LK810-040 05
500 x 2000*	495 - 510	LK810-050 05
600 x 2000*	595 - 610	LK810-060 05
700 x 2000	655 - 690	LK810-070 05
750 x 2000	705 - 740	LK810-075 05
800 x 2000	755 - 790	LK810-080 05
900 x 2000	855 - 890	LK810-090 05
1000 x 2000	955 - 990	LK810-100 05
1100 x 2000	1065 - 1100	LK810-110 05
1200 x 2000	1165 - 1200	LK810-120 05
1400 x 2000	1365 - 1400	LK810-140 05

10mm Glass Variants

700 x 2000	655 - 690	LK1010-070 05
800 x 2000	755 - 790	LK1010-080 05
900 x 2000	855 - 890	LK1010-090 05
1000 x 2000	955 - 990	LK1010-100 05
1100 x 2000	1055 - 1090	LK1010-110 05
1200 x 2000	1165 - 1200	LK1010-120 05

90° Bar Joining Kit for Side Panel SK-65

* Bracing Kit W8-052

Extended Bracing Bar (1200mm) E352-120

*200-600mm sizes supplied without bracing bar – Bracing Kit (W8-052) may be purchased separately.

20mm Extension Profile (LK8LEP 05 Silver) – see page 127.

Optional Ceiling Bracing Kit (W10-040) – see page 127.

All measurements are in mm

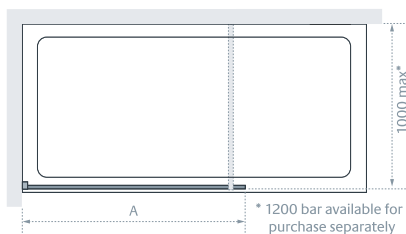

Shower Panel

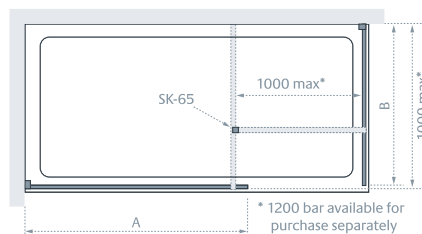

Shower Panel & Side Panel



Ceiling Bracing Kit
W10-040.



Pure
Vue^{HD}

Clearly
Superior
Glass

See page 4

Levanzo

8mm &
10mm
GLASS

The flexibility of the hinged bypass panel combines easy access with effective shielding of shower spray.

Shower Panel (A)

Standard Sizes (A x height)	Width Adjustment	Order Code
700 x 2000	670 - 705	LK810-070 05
750 x 2000	720 - 755	LK810-075 05
800 x 2000	770 - 805	LK810-080 05
900 x 2000	870 - 905	LK810-090 05
1000 x 2000	970 - 1005	LK810-100 05
1100 x 2000	1080 - 1115	LK810-110 05
1200 x 2000	1180 - 1215	LK810-120 05
1400 x 2000	1380 - 1415	LK810-140 05

10mm Glass Variants

700 x 2000	655 - 690	LK1010-070 05
800 x 2000	755 - 790	LK1010-080 05
900 x 2000	855 - 890	LK1010-090 05
1000 x 2000	955 - 990	LK1010-100 05
1100 x 2000	1055 - 1090	LK1010-110 05
1200 x 2000	1165 - 1200	LK1010-120 05

Hinged Bypass Panel (B)

Standard Sizes (B x height)	Width – No Adjustment	Order Code
200 x 2000*	200	LK827-20 05
300 x 2000	300	LK827-30 05
400 x 2000	400	LK827-40 05

10mm Glass Variants

200 x 2000*	200	LK1027-20 05
300 x 2000	300	LK1027-30 05
400 x 2000	400	LK1027-40 05

Optional Side Panel (C)

Standard Sizes (C x height)	Width Adjustment	Order Code
700 x 2000	655 - 690	LK810-070 05
750 x 2000	705 - 740	LK810-075 05
800 x 2000	755 - 790	LK810-080 05
900 x 2000	855 - 890	LK810-090 05
1000 x 2000	955 - 990	LK810-100 05

90° Bar Joining Kit for Side Panel	SK-65
------------------------------------	-------

20mm Extension Profile (LK8LEP 05 Silver) – see page 127.

*Should be used on tray depths of ≤750mm to ensure suitable opening is available.

The 200mm Hinged Bypass Panel is flat.

The 300mm and 400mm variants have a slight curvature.

The Hinged Bypass Panel can also be used with the Marseilles – see page 83.

All measurements are in mm



Please Note: To create your Levanzo shower enclosure you will need to select one product from each of the two tables.

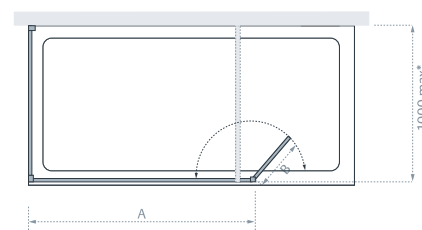

Shower Panel & Bypass Panel

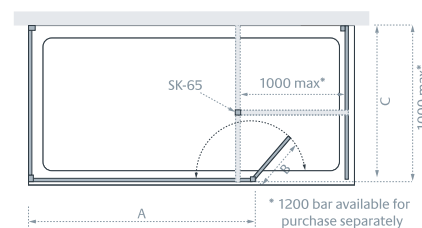

Shower Panel & Bypass Panel & Side Panel



Pure
Vue^{HD} Clearly
Superior
Glass

See page 4

Marseilles

8mm
GLASS

A modern classic reflecting real beauty in its simplicity.
Add a touch of glamour with natural textures, chic colourways
and luxurious accessories.

Shower Panel (A)

Standard Sizes (A x height)	Width – No Adjustment	Order Code
750 x 2000	755	LK815-075 05
850 x 2000	855	LK815-085 05
950 x 2000	955	LK815-095 05
1100 x 2000	1063	LK815-110 05
1200 x 2000	1163	LK815-120 05
1400 x 2000	1363	LK815-140 05

End Panel (B)

Standard Sizes (B x height)	Width Adjustment	Order Code
700 x 2000	670 - 705	LK818-070 05
750 x 2000	720 - 755	LK818-075 05
800 x 2000	770 - 805	LK818-080 05
900 x 2000	870 - 905	LK818-090 05
1000 x 2000	970 - 1005	LK818-100 05

Optional Side Panel (C)

Standard Sizes (C x height)	Width Adjustment	Order Code
700 x 2000	655 - 690	LK810-070 05
750 x 2000	705 - 740	LK810-075 05
800 x 2000	755 - 790	LK810-080 05
900 x 2000	855 - 890	LK810-090 05
1000 x 2000	955 - 990	LK810-100 05

90° Bar Joining Kit for Side Panel SK-65

20mm Extension Profile (LK8LEP 05 Silver) – see page 127.
Optional Ceiling Bracing Kit (W10-040) – see page 127.

All measurements are in mm

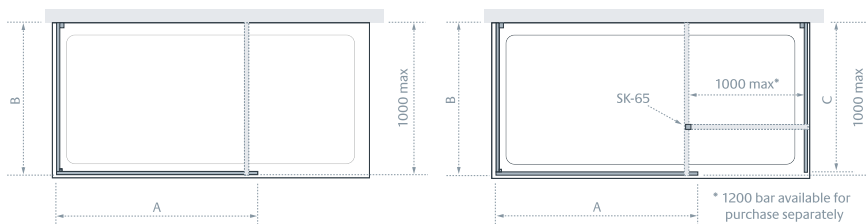

Shower Panel & End Panel

Shower Panel, End Panel & Side Panel



Please Note: To create your Marseilles shower enclosure you will need to select one product from each of the first two tables.



Ceiling Bracing Kit
W10-040.



Clearly
Superior
Glass

See page 4

Nice

8mm &
10mm
GLASS

Sometimes style is defined by understatement. With sleek profiles and the option to use in a wetroom or combine with a tray, the Nice is both discreet and practical.

Shower Panel (A)

Standard Sizes (A x height)	Width Adjustment	Order Code
800 x 2000	770 - 805	LK812-080 05
900 x 2000	870 - 905	LK812-090 05
1000 x 2000	970 - 1005	LK812-100 05
1100 x 2000	1080 - 1115	LK812-110 05
1200 x 2000	1180 - 1215	LK812-120 05
1400 x 2000	1380 - 1415	LK812-140 05

10mm Glass Variants

800 x 2000	770 - 805	LK1012-080 05
900 x 2000	870 - 905	LK1012-090 05
1000 x 2000	970 - 1005	LK1012-100 05
1100 x 2000	1080 - 1115	LK1012-110 05
1200 x 2000	1180 - 1215	LK1012-120 05

Bypass Panel (B)

Standard Sizes (B x height)	Width – No Adjustment	Order Code
200 x 2000*	200	LK812-20 05
320 x 2000	320	LK812-32 05
400 x 2000	397	LK812-40 05

10mm Glass Variants

200 x 2000*	200	LK1012-20 05
320 x 2000	320	LK1012-32 05

20mm Extension Profile (LK8LEP 05 Silver) – see page 127.

*Should be used on tray depths of ≤ 750 mm to ensure suitable opening is available.

All measurements are in mm

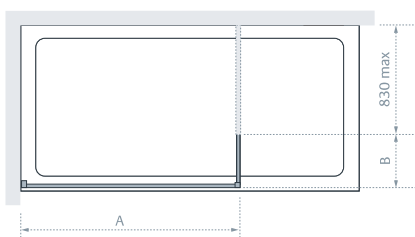

Shower Panel & Bypass Panel



Wetroom configuration

Please Note: To create your Nice shower enclosure you will need to select one product from each table (A & B) with the same glass thickness.



Clearly Superior Glass

See page 4

Palma

8mm
GLASS

Press pause and unwind in our beautifully framed and spacious Palma design. Combine with cool marble and rich tones for a contemporary boutique hotel feel.

Shower Panel (A)

Standard Sizes (A x height)	Width Adjustment	Order Code
800 x 2000	770 - 805	LK812-080 05
900 x 2000	870 - 905	LK812-090 05
1000 x 2000	970 - 1005	LK812-100 05
1100 x 2000	1080 - 1115	LK812-110 05
1200 x 2000	1180 - 1215	LK812-120 05
1400 x 2000	1380 - 1415	LK812-140 05

Bypass Panel (B)

Standard Sizes (B x height)	Width – No Adjustment	Order Code
200 x 2000*	200	LK812-20 05
320 x 2000	320	LK812-32 05
400 x 2000	397	LK812-40 05

Side Panel (C)

Standard Sizes (C x height)	Width Adjustment	Order Code
700 x 2000	655 - 690	LK810-070 05
750 x 2000	705 - 740	LK810-075 05
800 x 2000	755 - 790	LK810-080 05
900 x 2000	855 - 890	LK810-090 05
1000 x 2000	955 - 990	LK810-100 05

20mm Extension Profile (LK8LEP 05 Silver) – see page 127.

*Should be used on tray depths of ≤750mm to ensure suitable opening is available.

All measurements are in mm



Please Note: To create your Palma shower enclosure you will need to select one product from each table.

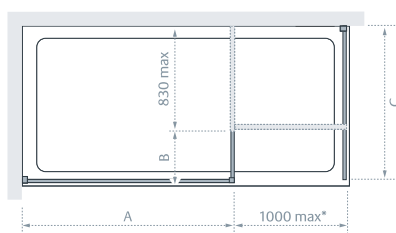

* 1200 bar available for purchase separately

Shower Panel, Side Panel & Bypass Panel



Pure
Vue^{HD}

Clearly
Superior
Glass

See page 4

Andora

8mm
GLASS

Strong, clean lines give the Andora a classic glamour that will stay looking fresh. With 8mm AllClear coated glass throughout, the side panels reduce splashing and make for effortless cleaning.

Shower Panel (A)

Standard Sizes (A x height)	Width – No Adjustment	Order Code
700 x 2000	720	LK814-070 05
750 x 2000	770	LK814-075 05
850 x 2000	870	LK814-085 05
950 x 2000	970	LK814-095 05
1050 x 2000	1078	LK814-105 05
1150 x 2000	1178	LK814-115 05
1350 x 2000	1378	LK814-135 05

Bypass Panel (B)

Standard Sizes (B x height)	Width – No Adjustment	Order Code
200 x 2000*	200	LK812-20 05
320 x 2000	320	LK812-32 05
400 x 2000	397	LK812-40 05

End Panel (C)

Standard Sizes (C x height)	Width Adjustment	Order Code
700 x 2000	670 - 705	LK818-070 05
750 x 2000	720 - 755	LK818-075 05
800 x 2000	770 - 805	LK818-080 05
900 x 2000	870 - 905	LK818-090 05
1000 x 2000	970 - 1005	LK818-100 05

20mm Extension Profile (LK8LEP 05 Silver) – see page 127.

*Should be used on tray depths of ≤750mm to ensure suitable opening is available.

All measurements are in mm

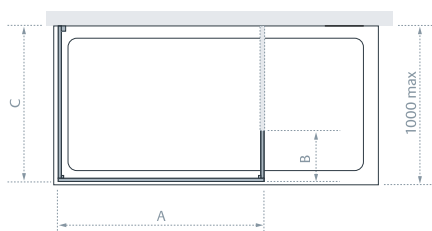

Shower Panel, End Panel & Bypass Panel



Please Note: To create your Andora shower enclosure you will need to select one product from each table.



Clearly
Superior
Glass

See page 4

Rhodes

8mm
GLASS

Maximum impact meets minimalist style and inspired design in our Rhodes enclosure. With its functional step-out area, it's a real sanctuary for blissful showering.

Shower Panel (A)

Standard Sizes (A x height)	Width – No Adjustment	Order Code
700 x 2000	720	LK814-070 05
750 x 2000	770	LK814-075 05
850 x 2000	870	LK814-085 05
950 x 2000	970	LK814-095 05
1050 x 2000	1078	LK814-105 05
1150 x 2000	1178	LK814-115 05
1350 x 2000	1378	LK814-135 05

Bypass Panel (B)

Standard Sizes (B x height)	Width – No Adjustment	Order Code
200 x 2000*	200	LK812-20 05
320 x 2000	320	LK812-32 05
400 x 2000	397	LK812-40 05

End Panel (C)

Standard Sizes (C x height)	Width Adjustment	Order Code
700 x 2000	670 - 705	LK818-070 05
750 x 2000	720 - 755	LK818-075 05
800 x 2000	770 - 805	LK818-080 05
900 x 2000	870 - 905	LK818-090 05
1000 x 2000	970 - 1005	LK818-100 05

Side Panel (D)

Standard Sizes (D x height)	Width Adjustment	Order Code
700 x 2000	655 - 690	LK810-070 05
750 x 2000	705 - 740	LK810-075 05
800 x 2000	755 - 790	LK810-080 05
900 x 2000	855 - 890	LK810-090 05
1000 x 2000	955 - 990	LK810-100 05

20mm Extension Profile (LK8LEP 05 Silver) – see page 127.

*Should be used on tray depths of ≤750mm to ensure suitable opening is available.

All measurements are in mm

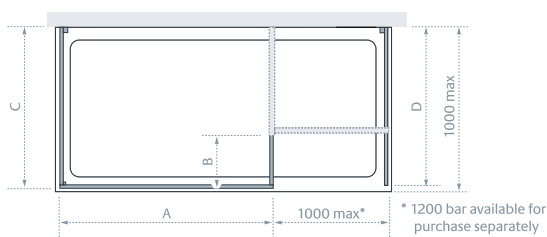

Shower Panel, End Panel, Side Panel & Bypass Panel



Please Note: To create your Rhodes shower enclosure you will need to select one product from each table.



Pure
Vue^{HD}

Clearly
Superior
Glass

See page 4

Riviera

8mm
GLASS

Make a statement in a larger bathroom and let this free-standing design take centre stage. Perfect for step-in, step-out showering in style.

Shower Panel (A)

Standard Sizes (A x height)	Width – No Adjustment	Order Code
1100 x 2000	1078	LK811-110 05
1200 x 2000	1178	LK811-120 05
1400 x 2000	1378	LK811-140 05

Bypass Panel (B) (2 Required – one at each side)

Standard Sizes (B x height)	Width – No Adjustment	Order Code
200 x 2000*	200	LK812-20 05
320 x 2000	320	LK812-32 05
400 x 2000	397	LK812-40 05

Shower Panel only (C) (Without bypass panels)

Standard Sizes (B x height)	Width – No Adjustment	Order Code
950 x 2000	950	LK819-095 05
1050 x 2000	1050	LK819-105 05
1150 x 2000	1150	LK819-115 05
1350 x 2000	1350	LK819-135 05

20mm Extension Profile (LK8LEP 05 Silver) – see page 127.

*Should be used on tray depths of ≤ 750 mm to ensure suitable opening is available.

All measurements are in mm

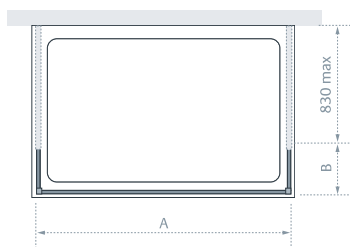

Shower Panel & Bypass Panels

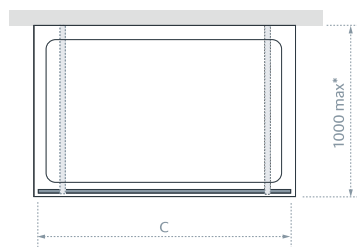

* 1200 bar available for purchase separately

Shower Panel only



Please Note: To create your Riviera shower enclosure you will need to select:

- one product from the first table and two identical products from the second table; or
- one product from the third table.

Pure
Vue^{HD}

Clearly
Superior
Glass

See page 4



Alassio

8mm
GLASS

Simplicity and practicality combine in our singularly understated hinged shower screen. Swing open for easier access and cleaning, swing back into position for an invigorating shower.



Hinged Shower Panel (A)

Standard Sizes (A x height)	Width Adjustment	Order Code
700 x 1900	675 - 700	LK850-070 05
800 x 1900	775 - 800	LK850-080 05
900 x 1900	875 - 900	LK850-090 05
1000 x 1900	975 - 1000	LK850-100 05

20mm Extension Profile (LK8LEP 05 Silver) – see page 127.
All measurements are in mm

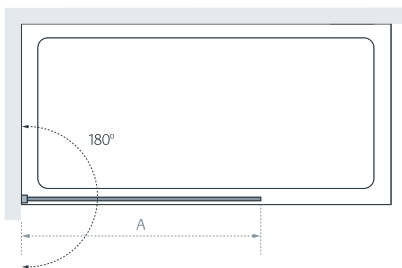

Hinged Shower Panel



Island Collection

Unframe your shower and escape to the beautiful purity of our Island Collection, inspired by the carefree spirit of the Caribbean.



Clearly
Superior
Glass

See page 4



Island Collection

8mm
GLASS



Clearly Superior Glass

See page 4



Barbados

8mm
GLASS

Less really is more with this frameless hinged door. Famed for its natural beauty and the simple life, there seemed no better name to give this pared back entrant to our new frameless range.



Door & Hinge Panel (A)

Standard Sizes (A x height)	Width Adjustment	Doorway Opening (D)	Order Code
750 x 2000	720 - 765	488	LK801-075 05
800 x 2000	760 - 805	528	LK801-080 05
900 x 2000	860 - 905	628	LK801-090 05
1000 x 2000	960 - 1005	728	LK801-100 05

20mm Extension Profile (LK8LEP 05 Silver) – see page 127.

This enclosure can be adjusted for out-of-plumb walls by a maximum of 15mm (for each mounting wall) over the height of the product. The hinge provides a further 15mm adjustment.

All measurements are in mm

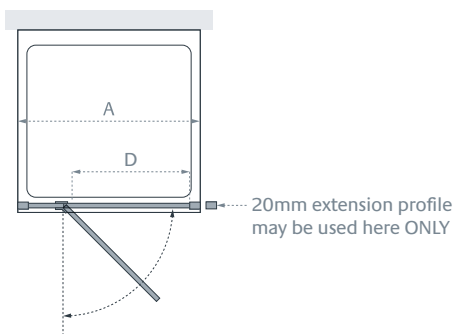



Pure
Vue^{HD}

Clearly
Superior
Glass

See page 4

Cayman

8mm
GLASS

Step barefoot into the embrace of our Cayman hinged door with in-line panel, bringing the most minimalist of enclosures to any alcove space and making the most of the clarity of our PureVue^{HD} glass.



Door, Hinge Panel & In-Line Panel (A)

Standard Size (A x height)	Width Adjustment	Doorway Opening (D)	Order Codes
1200 x 2000	1160 - 1205	628*	1 x LK801-090 05 & 1 x LK802-030 05
1400 x 2000	1360 - 1405	628*	1 x LK801-090 05 & 1 x LK802-050 05
1600 x 2000	1560 - 1605	628*	1 x LK801-090 05 & 1 x LK802-070 05

***Other 801 Door sizes may be used to create alternative enclosure sizes – see Barbados on previous page.**

20mm Extension Profile (LK8LEP 05 Silver) – see page 127.

This enclosure can be adjusted for out-of-plumb walls by a maximum of 15mm (for each mounting wall) over the height of the product. The hinge provides a further 15mm adjustment.

The required Bracing Bar for the In-Line Panel is included.

All measurements are in mm

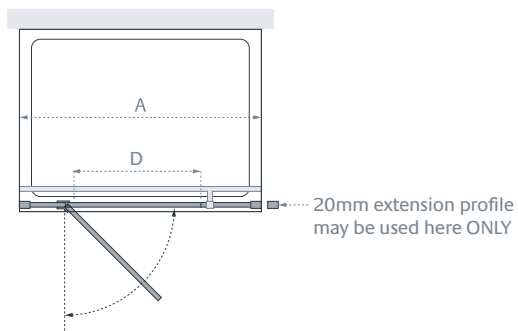



Clearly Superior Glass

See page 4

Grenada

8mm
GLASS

Beautifully understated and inspired by Grenada's wide horizons, it seems a misnomer to call this hinged door and side panel an enclosure at all, surrounded as you are by crystal clear, frameless glass.

Door & Hinge Panel (A)

Standard Sizes (A x height)	Width Adjustment	Doorway Opening (D)	Order Code
750 x 2000	720 - 750	488	LK801-075 05
800 x 2000	760 - 790	528	LK801-080 05
900 x 2000	860 - 890	628	LK801-090 05
1000 x 2000	960 - 990	728	LK801-100 05

Side Panel (B)

Standard Sizes (B x height)	Width Adjustment	Order Code
700 x 2000	670 - 685	LK805-070 05
750 x 2000	730 - 745	LK805-075 05
800 x 2000	770 - 785	LK805-080 05
900 x 2000	870 - 885	LK805-090 05
1000 x 2000	970 - 985	LK805-100 05

You *must* also order the following Bracing Bar to secure the Side Panel

Bracing Bar (C)

	Order Code
Bracing Bar	W8-052 05

20mm Extension Profile (LK8LEP 05 Silver) – see page 127.
This enclosure can be adjusted for out-of-plumb walls by a maximum of 15mm (for each mounting wall) over the height of the product. The hinge provides a further 15mm adjustment.

All measurements are in mm



Please Note: To create your Grenada enclosure you will need to select one product from each table.

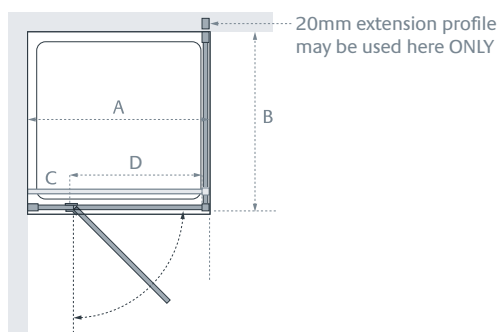



Clearly Superior Glass

See page 4

Martinique

8mm
GLASS

When lines are this clean and beautifully resolved, every detail really matters. Refined hinges, bracing bar and handle barely interrupt the ‘almost not there’ free-floating design of Martinique's hinged panel and door.



Door & Hinge Panel (A)

Standard Size (A x height)	Width Adjustment	Doorway Opening (D)	Order Codes
1200 x 2000	1160 - 1205	628*	1 x LK804-070 05 & 1 x LK803-050 05
1400 x 2000	1360 - 1405	628*	1 x LK804-070 05 & 1 x LK803-070 05
1600 x 2000	1560 - 1605	628*	1 x LK804-070 05 & 1 x LK803-090 05

***Other Door sizes may be used to create alternative enclosure sizes – please consult Lakes Bathrooms for advice .**

20mm Extension Profile (LK8LEP 05 Silver) – see page 127.

This enclosure can be adjusted for out-of-plumb walls by a maximum of 15mm (for each mounting wall) over the height of the product. The hinge provides a further 15mm adjustment.

The required Bracing Bar for the Hinge Panel is included.

All measurements are in mm

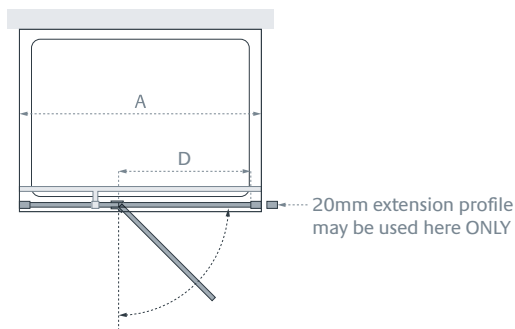



Pure
Vue^{HD}

Clearly
Superior
Glass

See page 4

Tobago

8mm
GLASS

Frame free and carefree, with its hinged panel, door and side panel Tobago is the glistening jewel in the crown of this Caribbean inspired Island range – a winning combination of simplicity and sophistication.



Door & Hinge Panel (A)

Standard Size (A x height)	Width Adjustment	Doorway Opening (D)	Order Codes
1200 x 2000	1160 - 1190	628*	1 x LK804-070 05 & 1 x LK803-050 05
1400 x 2000	1360 - 1390	628*	1 x LK804-070 05 & 1 x LK803-070 05
1600 x 2000	1560 - 1590	628*	1 x LK804-070 05 & 1 x LK803-090 05

Please Note: To create your Tobago enclosure you will need to select one product from each table.

Side Panel (B)

Standard Sizes (B x height)	Width Adjustment	Order Code
700 x 2000	670 - 685	LK805-070 05
750 x 2000	730 - 745	LK805-075 05
800 x 2000	770 - 785	LK805-080 05
900 x 2000	870 - 885	LK805-090 05
1000 x 2000	970 - 985	LK805-100 05

***Other Door sizes may be used to create alternative enclosure sizes – please consult Lakes Bathrooms for advice .**

20mm Extension Profile (LK8LEP 05 Silver) – see page 127.

This enclosure can be adjusted for out-of-plumb walls by a maximum of 15mm (for each mounting wall) over the height of the product. The hinge provides a further 15mm adjustment.

The required Bracing Bar for the Hinge Panel and Side Panel is included.

All measurements are in mm

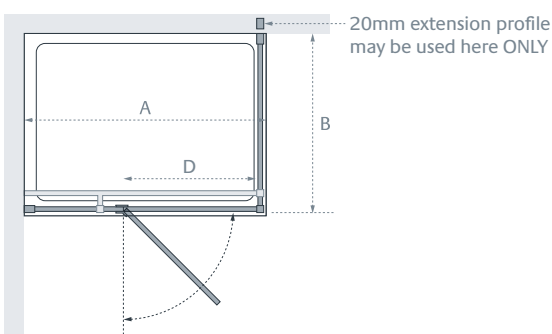

Bath Screens

The convenience of an invigorating shower or the indulgence of soaking in a long, hot bath. With one of our bath screens you can enjoy the best of both worlds.



Clearly
Superior
Glass

See page 4





**Pure
Vue^{HD}**

Clearly
Superior
Glass

See page 4

Coastline 8mm Hinged Bath Screen

8mm
GLASS

Elegance and functionality combine to transform any bath into a luxurious showering space.



Specifications

Overall Size (width x height)	Fixed Panel (width adjustment)	Door (width)	Order Code Silver
900 - 915 x 1500	292 - 307	608	SS100L/R 05
1000 - 1015 x 1500	492 - 507	508	SS105L/R 05

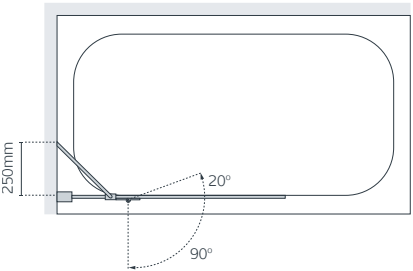

Left-hand opening

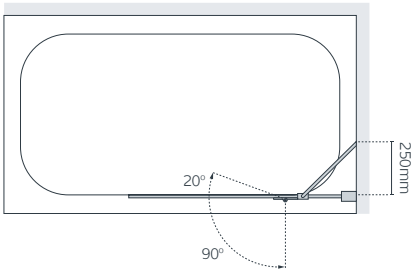

Right-hand opening

IMPORTANT: Please specify whether you require a left-hand or right-hand opening Bath Screen when ordering.



Clearly
Superior
Glass

See page 4



Classic Curved Hinged Bath Screen

6mm
GLASS

Ease of access, elegant curves and effective sealing combine for a great value bath and shower solution.



Specifications

Overall Size (width x height)	Fixed Panel (width adjustment)	Door (width)	Order Code <i>Silver</i>
930 - 955 x 1400	540 - 565	390	SS120 05

All measurements are in mm

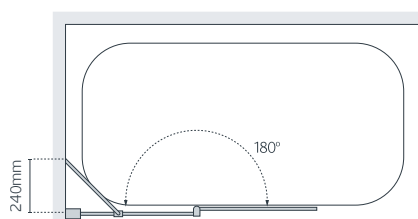



Clearly
Superior
Glass

See page 4



Classic & Coastline Curved Bath Screen

6mm &
8mm
GLASS

An elegantly simple solution with an attractive curve to the top of the screen and effective sealing along the bath top.



SS11 05 Silver Single Panel
Curved Bath Screen with Towel Rail



SS20 05 Silver Double Panel
Curved Bath Screen



SS22 05 Silver Double Panel
Curved Bath Screen with Towel Rail

Specifications

Standard Sizes (width x height)	Width Adjustment	Order Code Silver	Order Code White
800 x 1400	800 - 825	SS10 05	SS10 30
800 x 1400	800 - 825	SS11 05 (with towel rail)	n/a
975 (315 + 660) x 1400	975 - 1000	SS20 05	n/a
975 (315 + 660) x 1400	975 - 1000	SS22 05 (with towel rail)	n/a

8mm Glass Variant

800 x 1400	800 - 825	BS810 05	n/a
------------	-----------	----------	-----

All measurements are in mm

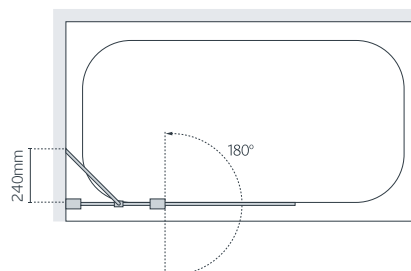
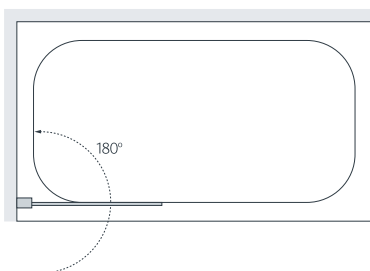



Clearly
Superior
Glass

See page 4

Classic Sculpted Bath Screen

6mm
GLASS

Our contemporary sculpted screen provides the perfect shower over your bath and is available with or without a convenient towel rail.



SS30 05 Silver Single Panel
Sculpted Bath Screen



SS33 05 Silver Single Panel
Sculpted Bath Screen with Towel Rail



SS40 05 Silver Double Panel
Sculpted Bath Screen

Specifications

Standard Sizes (width x height)	Width Adjustment	Order Code Silver
860 x 1400	860 - 885	SS30 05
860 x 1400	860 - 885	SS33 05 (with towel rail)
1175 (375 + 800) x 1400	1175 - 1200	SS40 05
1175 (375 + 800) x 1400	1175 - 1200	SS44 05 (with towel rail)

All measurements are in mm

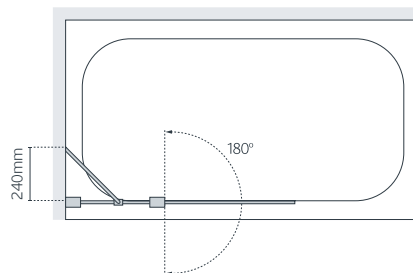
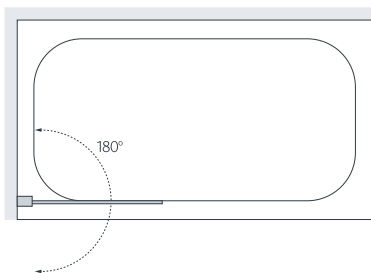



Clearly
Superior
Glass

See page 4



Classic & Coastline Square Bath Screen

6mm &
8mm
GLASS

Crisp, clean lines make the perfect marriage of form and function. A distinctively deep screen can be created using the double panel screen.



SS50 05 Silver Single Panel Square Bath Screen



SS60 05 Silver Double Panel Square Bath Screen



SS66 05 Silver Double Panel Square Bath Screen with Towel Rail

Specifications

Standard Sizes (width x height)	Width Adjustment	Order Code Silver
800 x 1500	800 - 825	SS50 05
800 x 1500	800 - 825	SS55 05 (with towel rail)
944 (318 + 626) x 1500	945 - 970	SS60 05
944 (318 + 626) x 1500	945 - 970	SS66 05 (with towel rail)

8mm Glass Variant

800 x 1500	800 - 825	BS850 05
------------	-----------	----------

All measurements are in mm

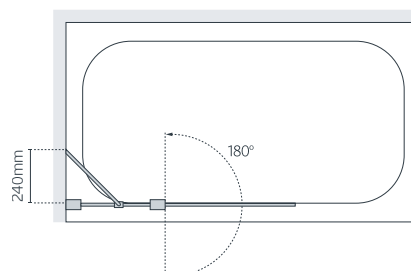
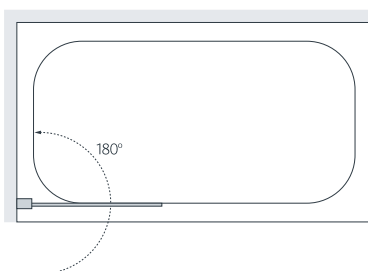



Pure
Vue^{HD}

Clearly
Superior
Glass

See page 4

Classic Framed Bath Screens

4mm
GLASS

For a more traditional bath screen choose our classic framed design, available as a single screen, a double or triple folding option, or a four panel concertina design.



SS70 30 White Single Panel Framed Bath Screen



SS75 05 Silver Double Panel Framed Bath Screen



SS80 05 Silver Triple Panel Framed Bath Screen

Specifications

Standard Sizes (width x height)	Width Adjustment	Order Code Silver	Order Code White
760 x 1400	760 - 785	SS70 05	SS70 30
950 (525 + 425) x 1400	950 - 975	SS75 05	SS75 30
1390 (525 + 438 + 427) x 1400	1390 - 1415	SS80 05	SS80 30
730 (250 + 166 + 166 + 148) x 1400	730 - 755	SS85 05	SS85 30

All measurements are in mm

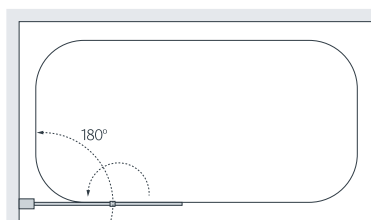

Single/Double Panel

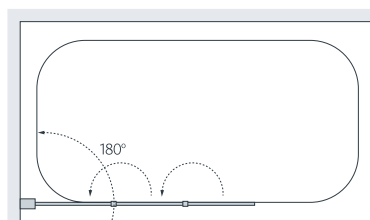

Triple Panel

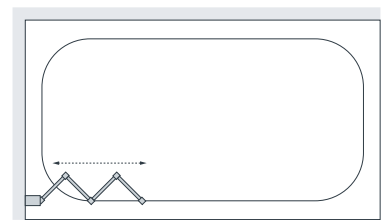

Four Panel



Clearly
Superior
Glass

See page 4



Classic Shower Curtain Panel

6mm
GLASS

Our shower curtain panel is a fixed short screen that's styled and engineered to perfectly complement the use of a shower curtain by providing an additional barrier from water spray.



Specifications

Standard Sizes <i>(width x height)</i>	Width Adjustment	Order Code <i>Silver</i>
300 x 1400	298 - 323	SS90 05
300 x 1500	298 - 323	SS95 05

All measurements are in mm

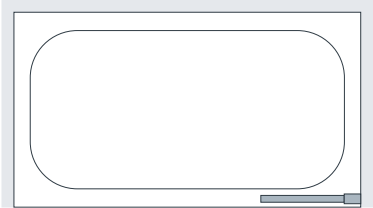



A close-up, slightly blurred photograph of a white shower tray. In the upper right corner, a circular drain is visible. The background shows a light-colored wall or ceiling. The text is overlaid on the right side of the image.

Specifications, Shower Trays and Accessories

The same high standards we employ in the manufacture of our enclosures and bath screens are reflected in our shower trays and accessories.

Specifications

Quality is all about detail and whichever enclosure you choose you'll find real attention has been paid to every aspect of design, function and finish.

Please note: All measurements are approximate and subject to change without prior notification. All product images are for illustration only and subject to change without prior notification.

Frames

Our elegant aluminium frames are available in two distinctive finishes. Choose from anodized polished silver or a clean white powder coated finish. All enclosures, doors and screen heights are measured from the top of the tray or bath.



Choose from Polished Silver Anodized or White Powder Coated finish



Concealed fixings: Classic Semi-Frameless: Walk In (including side and end panels), and Shower Screen.
Coastline Collection: all products except Alassio.
Bath screens: SS100/105



Semi-Frameless Cover Caps

Safety Glass

In cheaper enclosures it's often the quality of the glass which suffers. Our products are sculpted from toughened glass, approved to BSI EN12150-1 in a range of thicknesses (see product pages).

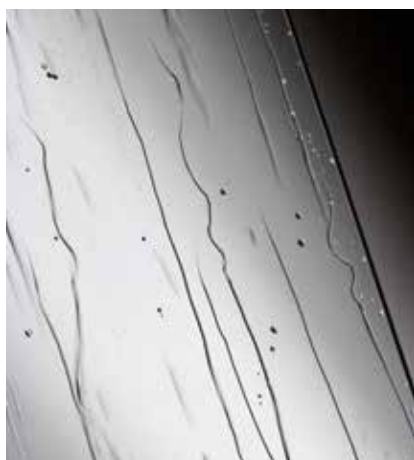

Toughened Safety Glass

Handles

Smart and practical loop type handles in matching Chrome Plate / White Powder Coat are fitted to all semi frameless products.

A new option loop handle is now available for Classic Semi-Frameless products. See pages: 29, 31, 33, 37, 39, 41, 43, 45, 53.



Bright Chrome Plate Stainless Steel Bow Handles (Classic Collection)



Alternative Bright Chrome Plate Stainless Steel Loop Handles (Classic Semi-Frameless Collection)



Die-cast Chrome Bow Handles (Coastline Collection)

Flexibility

Many of our products can be made available in special heights and widths. Please contact Lakes Bathrooms for more details.

Extension Profiles

Our high quality extension profiles can be used to bridge gaps in non-standard sized openings (detailed on relevant product pages).



LEP – Aluminium Extension Profile for the Classic Ranges

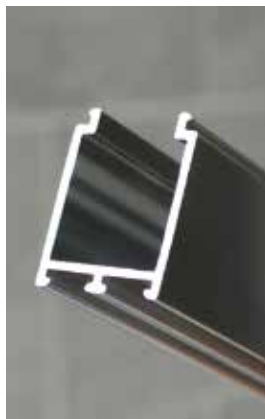

LK8LEP – Aluminium Extension Profile for the Coastline Frameless and Island Ranges

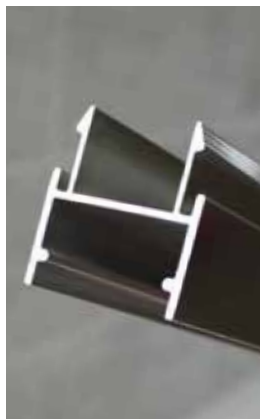

8HLEP – Aluminium Extension Profile for the Coastline Semi-Frameless Range

Optional Ceiling Bracing Kits

LKSS-C150: Available for Classic Collection Walk-In (P.49) and Shower Screen (p.51).
W10-040: Available for Coastline Collection Cannes (p.79) and Marseilles (p.83).



Ceiling Bracing Kit LKSS-C150



Ceiling Bracing Kit W10-040

Doors and Seals

All our doors are fitted with an easy glide mechanism. All sliding doors in the Classic and Coastline semi-frameless ranges feature roller bearings and clips, which are adjustable to allow for fine tuning of door alignment and clip out to allow for easy cleaning.

Magnetic seals feature across the Classic & Island Collection as well as the Valmiera and Malmo models in the Coastline Collection Semi-Frameless Range, whilst the remainder of this range utilises a discreet cushion-fit seal.



Classic Collection Roller Bearings and Clips



Coastline Collection Roller Bearings and Clips

PureVue^{HD} Glass Imagery

Imagery has been retouched to accurately portray the colour difference between 10mm PureVue^{HD} glass and standard float glass under daylight conditions.



Additional Strength

Bracing arms provide additional support, strength and safety for all double panel bath screens and our elegant Walk In and Shower Screen enclosures.

Adaptability

For the perfect finish every enclosure has an adjustment for out of true walls built into each wall profile. The full range of tolerance is shown in the dimensions chart on each page.

Versatility

To match your room design all enclosures, doors and the majority of bath screens are designed for left or right hand fitting. However, please consult Lakes Bathrooms before ordering to ensure compatibility with site conditions.



Double Panel Bath Screen Bracing Arm



Adjustable Wall Profiles



Shower Trays

Our trays are available in traditional stone resin and contemporary lightweight designs.

All have a high quality surface finish and are available in a choice of styles to suit your available space. Lightweight trays (max 30kg for the largest size) have a 45mm low profile. Stone resin trays are available in a 45mm low profile or in standard 80mm height.

Please note: There is an additional delivery charge when ordering a single tray without an enclosure.



Tray Ranges

IMPORTANT: Waste positions vary depending on tray shape and type i.e. Lightweight or Stone Resin.
 For a full technical data sheet, visit www.lakesbathrooms.co.uk/traydatasheet.

Standard Tray Shapes

Trays can be supplied to fit all models. Quadrants are designed to fit a 550mm tray radius. All Walk-In enclosures may be fitted to a wide range of tray sizes; please contact Lakes Bathrooms for advice. Certain trays may vary slightly from those shown.



Square



Rectangular



Quadrant / Offset Quadrant



Pentagon

Easy-Plumb Kits

All our Easy-Plumb Kits are supplied complete with legs & panels.



Acrylic Capped Resin (ABS) Tray and Easy-Plumb Kit with Velcro side panels



Flexi-waste Kit (Product code: T-FLEXI-PIPE)



80mm Stone Resin Tray and Easy-Plumb Kit



Versatile Seal Strip
 (Product code: T-SEALING-STRIP)



90mm Waste
 Suitable for all low profile trays



Acrylic Capped Resin (ABS) Tray with square raised drying area

Drying Area Tray

We also offer a special rectangular tray with an integrated drying area, which is available in a number of sizes (see over for details).

Contemporary Lightweight Trays (one-man lift)

Please note: There is an additional delivery charge when ordering a single tray without an enclosure.

Tray Type	Product Code	Size (mm)	Additional Information	Material
QUADRANT (550mm Radius) Low Profile complete with 90mm waste	TQ88-ELA	800 x 800	Waste on centre of radius	ABS
	TQ99-ELB	900 x 900		ABS
	TQ11-ELC	1000 x 1000		ABS

Tray Type	Product Code	Size (mm)	Additional Information	Material
OFFSET QUADRANT (550mm Radius) Low Profile complete with 90mm waste	TQ9076L-ELD	900 x 760	Waste on centre of radius	ABS
	TQ9076R-ELE	900 x 760		ABS
	TQ9080L-ELF	900 x 800		ABS
	TQ9080R-ELG	900 x 800		ABS
	TQ8010L-ELH	1000 x 800		ABS
	TQ8010R-ELI	1000 x 800		ABS
	TQ8012L-ELJ	1200 x 800		ABS
	TQ8012R-ELK	1200 x 800		ABS
	TQ9012L-ELL	1200 x 900		ABS
	TQ9012R-ELM	1200 x 900		ABS

Tray Type	Product Code	Size (mm)	Additional Information	Material
RECTANGULAR Low Profile complete with 90mm waste	TR9076-ELN	900 x 760	Waste on centre of long side	ABS
	TR9080-ELO	900 x 800		ABS
	TR7010-ELP	1000 x 700		ABS
	TR7610-ELQ	1000 x 760		ABS
	TR8010-ELR	1000 x 800		ABS
	TR9010-ELS	1000 x 900		ABS
	TR7011-ELT	1100 x 700		ABS
	TR7611-ELU	1100 x 760		ABS
	TR8011-ELV	1100 x 800		ABS
	TR9011-ELW	1100 x 900		ABS
	TR7012-ELX	1200 x 700		ABS
	TR7612-ELY	1200 x 760		ABS
	TR8012-ELZ	1200 x 800		ABS
	TR9012-EMA	1200 x 900		ABS
	TR1012-EMB	1200 x 1000		ABS
	TR8014-EMC	1400 x 800		ABS
	TR9014-EMD	1400 x 900		ABS
	TR7015-EME	1500 x 700		ABS
	TR7615-EMF	1500 x 760		ABS
	TR8015-EMG	1500 x 800		ABS
	TR9015-EMH	1500 x 900		ABS
	TR7016-EMI	1600 x 700		ABS
	TR8016-EMJ	1600 x 800		ABS
	TR9016-EMK	1600 x 900		ABS
	TR7017-EML	1700 x 700		ABS
	TR7617-EMM	1700 x 760		ABS
	TR8017-EMN	1700 x 800		ABS
	TR9017-EMO	1700 x 900		ABS
	TR1017-EMP	1700 x 1000		ABS
	TR8018-EMQ	1800 x 800		ABS
	TR9018-EMR	1800 x 900		ABS
	TR1018-EMS	1800 x 1000		ABS
	TR8020-EMT	2000 x 800		ABS
	TR9020-EMU	2000 x 900		ABS
TR1020-EMV	2000 x 1000	ABS		

Rectangular trays continued over page.

Tray Type	Product Code	Size (mm)	Additional Information	Material
RECTANGULAR With Raised Drying Area Low Profile complete with 90mm waste	TW9014-EMW	1400 ¹ x 900	Waste on centre of short side (at showering end)	ABS
	TW8016-EMX	1600 ² x 800		ABS
	TW8017-EMY	1700 ³ x 800		ABS

¹Shower Width 800mm x Drying Length 600mm

²Shower Width 920mm x Drying Length 680mm

³Shower Width 1020mm x Drying Length 680mm

Tray Type	Product Code	Size (mm)	Additional Information	Material
SQUARE Low Profile complete with 90mm waste	TS77-ENB	700 x 700	Waste on centre of tray side	ABS
	TS7676-ENC	760 x 760		ABS
	TS88-END	800 x 800		ABS
	TS99-ENE	900 x 900		ABS
	TS11-ENF	1000 x 1000		ABS

Tray Type	Product Code	Size (mm)	Additional Information	Material
PENTAGON Low Profile complete with 90mm waste	TP99-ENG	900 x 900	Waste on centre of diagonal side	ABS

Easy-Plumb Kits (suitable for use with all Contemporary Lightweight Trays)

The following Easy-Plumb Kit systems are specifically designed to convert any of the trays on these two pages to a raised installation.

Tray Type	Product Code	Additional Information
SQUARE, RECTANGULAR AND PENTAGON	T EP KIT ENH	All Square, Pentagon, and Rectangular up to 1200mm

Tray Type	Product Code	Additional Information
RECTANGULAR Up to 2000mm	T EP KIT ENI	Rectangular >1200mm up to 2000mm

Tray Type	Product Code	Additional Information
QUADRANT AND OFFSET QUADRANT	T EP KIT ENJ	All Quadrants and Offset Quadrants

Tray Type	Product Code	Additional Information
BASE BOARD	T EP KIT ENK	Base Board Kits recommended for trays over 1200mm*

*Tray guarantee requires use of this kit or alternative fully supported base.

Tray Waste

Tray Type	Product Code	Size (mm)	Additional Information
ALL LOW PROFILE TRAYS	T WASTE	90mm waste	All Low Profile Trays 90mm waste

Tray Heights

Tray Profile: 45mm approx.

Wastes

All trays are supplied complete with chrome waste to suit. Waste position is dependent on the type of tray selected. Complies with EN274-1. Please contact Lakes Bathrooms for advice.

10 Year Guarantee

All our trays are engineered and manufactured to exacting standards and carry a 10 year guarantee against manufacturing defects.

Traditional Stone Resin Trays

Please note: There is an additional delivery charge when ordering a single tray without an enclosure.

Low Profile

Tray Type	Product Code	Size (mm)	Additional Information	Material
QUADRANT (550mm Radius) Low Profile complete with 90mm waste	AATQ88	800 x 800	Corner Waste	ABS stone
	AATQ99	900 x 900	Corner Waste	ABS stone

Tray Type	Product Code	Size (mm)	Additional Information	Material
OFFSET QUADRANT (550mm Radius) Low Profile complete with 90mm waste	AATQ9076L	900 x 760	Left Hand Corner Waste	ABS stone
	AATQ9076R	900 x 760	Right Hand Corner Waste	ABS stone
	AATQ8010L	1000 x 800	Left Hand Corner Waste	ABS stone
	AATQ8010R	1000 x 800	Right Hand Corner Waste	ABS stone
	AATQ8012L	1200 x 800	Left Hand Corner Waste	ABS stone
	AATQ8012R	1200 x 800	Right Hand Corner Waste	ABS stone
	AATQ9012L	1200 x 900	Left Hand Corner Waste	ABS stone
	AATQ9012R	1200 x 900	Right Hand Corner Waste	ABS stone

Tray Type	Product Code	Size (mm)	Additional Information	Material
RECTANGULAR Low Profile complete with 90mm waste	AATR8070	800 x 700	Corner Waste	ABS stone
	AATR9070	900 x 700	Corner Waste	ABS stone
	AATR9076	900 x 760	Corner Waste	ABS stone
	AATR9080	900 x 800	Corner Waste	ABS stone
	AATR7010	1000 x 700	Corner Waste	ABS stone
	AATR7610	1000 x 760	Corner Waste	ABS stone
	AATR8010	1000 x 800	Corner Waste	ABS stone
	AATR9010	1000 x 900	Corner Waste	ABS stone
	AATR7612	1200 x 760	Corner Waste	ABS stone
	AATR8012	1200 x 800	Corner Waste	ABS stone
	AATR9012	1200 x 900	Corner Waste	ABS stone
	AATR9014	1400 x 900	Corner Waste	ABS stone
	AATR7015	1500 x 700	Corner Waste	ABS stone
	AATR9015	1500 x 900	Corner Waste	ABS stone
	AATR7016	1600 x 700	Corner Waste	ABS stone
	AATR7616	1600 x 760	Corner Waste	ABS stone
	AATR8016	1600 x 800	Corner Waste	ABS stone
	AATR9016	1600 x 900	Corner Waste	ABS stone
AATR7017	1700 x 700	Corner Waste	ABS stone	
AATR9017	1700 x 900	Corner Waste	ABS stone	

Tray Type	Product Code	Size (mm)	Additional Information	Material
SQUARE Low Profile complete with 90mm waste	AATS7676	760 x 760	Corner Waste	ABS stone
	AATS88	800 x 800	Corner Waste	ABS stone
	AATS99	900 x 900	Corner Waste	ABS stone
	AATS11	1000 x 1000	Corner Waste	ABS stone

Easy-Plumb Kits (suitable for use with all Traditional Stone Resin Trays)

The following Easy-Plumb Kit systems are specifically designed to convert any of the trays on these two pages to a raised installation.

Tray Type	Product Code	Additional Information
QUADRANT / OFFSET QUADRANT	AZT EP KIT Q10	Lakes Easy-Plumb Kit Suits all Quadrants and Offset Quadrants up to 1000mm in size
	AZT EP KIT Q12	Lakes Easy-Plumb Kit Suits all Quadrants and Offset Quadrants up to 1200mm in size

Tray Type	Product Code	Additional Information
SQUARE AND RECTANGULAR	AZT EP KIT SR12	Lakes Easy-Plumb Kit Suits all Square and Rectangular trays up to 1200mm in size
	AZT EP KIT SR17	Lakes Easy-Plumb Kit Suits all Square and Rectangular trays up to 1700mm in size

Standard Height

Tray Type	Product Code	Size (mm)	Additional Information	Material
QUADRANT (550mm Radius) Standard Height complete with 50mm waste	ZZTQ88	800 x 800	Corner Waste	ABS stone
	ZZTQ99	900 x 900	Corner Waste	ABS stone

Tray Type	Product Code	Size (mm)	Additional Information	Material
OFFSET QUADRANT (550mm Radius) Standard Height complete with 50mm waste	ZZTQ9076L	900 x 760	Left Hand Corner Waste	ABS stone
	ZZTQ9076R	900 x 760	Right Hand Corner Waste	ABS stone
	ZZTQ9080L	900 x 800	Left Hand Corner Waste	ABS stone
	ZZTQ9080R	900 x 800	Right Hand Corner Waste	ABS stone
	ZZTQ8010L	1000 x 800	Left Hand Corner Waste	ABS stone
	ZZTQ8010R	1000 x 800	Right Hand Corner Waste	ABS stone
	ZZTQ8012L	1200 x 800	Left Hand Corner Waste	ABS stone
	ZZTQ8012R	1200 x 800	Right Hand Corner Waste	ABS stone
	ZZTQ9012L	1200 x 900	Left Hand Corner Waste	ABS stone
	ZZTQ9012R	1200 x 900	Right Hand Corner Waste	ABS stone

Tray Type	Product Code	Size (mm)	Additional Information	Material
RECTANGULAR Standard Height complete with 50mm waste	ZZTR7080	800 x 700	Corner Waste	ABS stone
	ZZTR7090	900 x 700	Corner Waste	ABS stone
	ZZTR9076	900 x 760	Corner Waste	ABS stone
	ZZTR9080	900 x 800	Corner Waste	ABS stone
	ZZTR7010	1000 x 700	Corner Waste	ABS stone
	ZZTR7610	1000 x 760	Corner Waste	ABS stone
	ZZTR8010	1000 x 800	Corner Waste	ABS stone
	ZZTR9010	1000 x 900	Corner Waste	ABS stone
	ZZTR7011	1100 x 700	Corner Waste	ABS stone
	ZZTR7611	1100 x 760	Corner Waste	ABS stone
	ZZTR8011	1100 x 800	Corner Waste	ABS stone
	ZZTR7012	1200 x 700	Corner Waste	ABS stone
	ZZTR7612	1200 x 760	Corner Waste	ABS stone
	ZZTR8012	1200 x 800	Corner Waste	ABS stone
	ZZTR9012	1200 x 900	Corner Waste	ABS stone
	ZZTR1012	1200 x 1000	Corner Waste	ABS stone
	ZZTR8014	1400 x 800	Corner Waste	ABS stone
	ZZTR9014	1400 x 900	Corner Waste	ABS stone
	ZZTR7615	1500 x 760	Corner Waste	ABS stone
	ZZTR8016	1600 x 800	Corner Waste	ABS stone
ZZTR7017	1700 x 700	Corner Waste	ABS stone	

Tray Type	Product Code	Size (mm)	Additional Information	Material
SQUARE Standard Height complete with 50mm waste	ZZTS77	700 x 700	Corner Waste	ABS stone
	ZZTS7676	760 x 760	Corner Waste	ABS stone
	ZZTS88	800 x 800	Corner Waste	ABS stone
	ZZTS99	900 x 900	Corner Waste	ABS stone
	ZZTS11	1000 x 1000	Corner Waste	ABS stone

Tray Waste

Tray Type	Product Code	Size (mm)	Additional Information
ALL LOW PROFILE TRAYS	T WASTE	90mm waste	Suitable for all low profile trays
ALL STANDARD HEIGHT TRAYS	ZZT WASTE	50mm waste	Suitable for all standard height trays

Tray Heights

Low Profile: 45mm approx.
Standard Height: 80mm approx.

Trays with Upstands

Shower trays with upstands are available on request. Contact Lakes Bathrooms for advice.

Wastes

All trays are supplied complete with chrome waste to suit. Waste position is dependent on the type of tray selected. Complies with EN274-1. Please contact Lakes Bathrooms for advice.

10 Year Guarantee

All our trays are engineered and manufactured to exacting standards and carry a 10 year guarantee against manufacturing defects.

Accessories

Our range of practical and stylish accessories are engineered for durability and designed to perform beautifully. Each one carries our 10 year guarantee against manufacturing defects.



Grab Bars & Rails

Series 400 FOLDING SUPPORT HANDLE



Available in chrome

Series 400 FIXED SUPPORT HANDLE



Available in chrome



Optional toilet roll holder

RAILS



A wide range of bar configurations is available to suit most spaces. Please contact Lakes Bathrooms if advice is required.



Series 150 Handrail – available in chrome



Series 400 Handrail – available in chrome

Shower Seats

ANIMO RD



Available in white

SERIES 150 RD



Available in chrome/grey, chrome/white

SERIES 200 RD



Fixings available in white, gold or chrome

SERIES 200 SD



Fixings available in white, gold or chrome

SERIES 300 SD



Available in chrome/grey, chrome/white, white

Shower Seats

All dimensions are in millimetres

Product	Description	Code	Fixings colour	A	B	C	D
---------	-------------	------	----------------	---	---	---	---

ANIMO RD

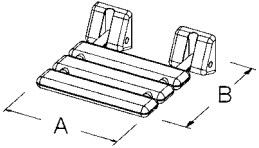
	Shower seat	001RD31	White	320	320		
---	-------------	---------	-------	-----	-----	--	--

SERIES 150 RD

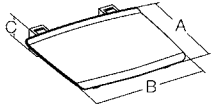
	Shower seat	0015RD05	Chrome/grey	325	325	60	
		0015RD69	Chrome/white	325	325	60	

SERIES 200 RD

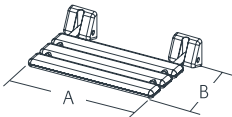
	Shower seat in Iroko hardwood	002RD31PM	White	489	330		
		002RD03PM	Gold	489	330		
		002RD05PM	Chrome	489	330		

SERIES 200 SD

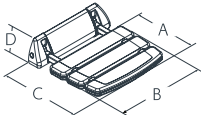
	Shower seat	0020SD31PM	White	240	350	337	105
		0020SD29PM	White/Gold	240	350	337	105
		0020SD69PM	White/Chrome	240	350	337	105

SERIES 300 SD

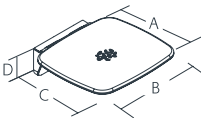
	Shower seat	3020SD31PM	White	330	355	370	105
		3020SD69PM	Chrome/White	330	355	370	105
		3020SD05PM	Chrome/Grey	330	355	370	105

Rails

All dimensions are in millimetres

Product	Description	Code	Colour	A	B
---------	-------------	------	--------	---	---

SERIES 150 STEEL SG

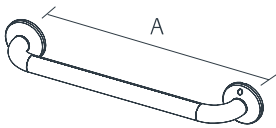
	Holding handle	3001SG05	Chrome	250	
		3002SG05	Chrome	450	
		3003SG05	Chrome	550	
		3004SG05	Chrome	650	

	Wall handle 145° reversible	3010SG05	Chrome	580	480
		3011SG05	Chrome	680	480
		3012SG05	Chrome	680	580

	Wall handle 90° reversible	3015SG05	Chrome	600	450
		3016SG05	Chrome	700	450
		3017SG05	Chrome	700	450

Grab Bars & Rails All dimensions are in millimetres

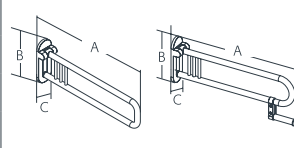
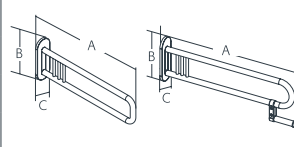
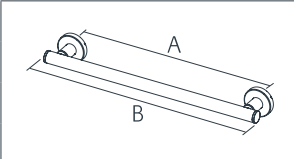
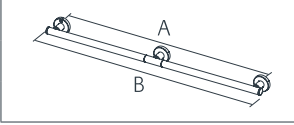
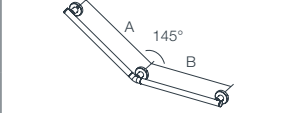
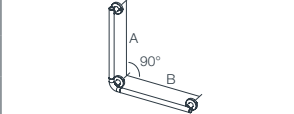
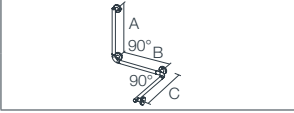
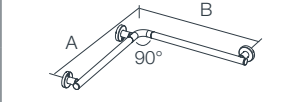
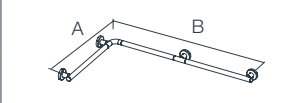
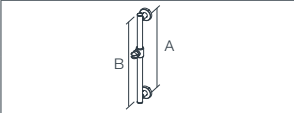
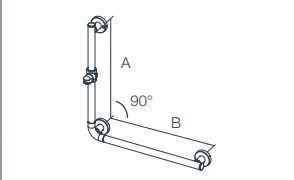
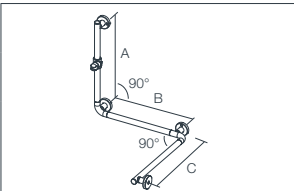
Product	Description	Code	Colour	A	B	C
SERIES 400 STEEL SG						
	Folding support handle	4045SG05PM	Chrome	650	280	100
	Folding support handle	4046SG05PM	Chrome	750	280	100
	Folding support handle with toilet roll holder	4245SG05PM	Chrome	650	280	100
	Folding support handle with toilet roll holder	4246SG05PM	Chrome	750	280	100
	Fixed support handle	3040SG05PM	Chrome	650	280	100
	Fixed support handle	3041SG05PM	Chrome	750	280	100
	Fixed support handle with toilet roll holder	3042SG05PM	Chrome	650	280	100
	Fixed support handle with toilet roll holder	3043SG05PM	Chrome	750	280	100
	Holding handle	4001SG05PM	Chrome	250	330	
		4002SG05PM	Chrome	450	530	
		4003SG05PM	Chrome	550	630	
		4004SG05PM	Chrome	650	730	
	Wall handrail	4005SG05PM	Chrome	1050	1130	
		4006SG05PM	Chrome	1150	1230	
		4007SG05PM	Chrome	1250	1330	
	Wall handle 145° reversible	4010SG05PM	Chrome	580	480	
		4011SG05PM	Chrome	680	480	
		4012SG05PM	Chrome	680	580	
	Wall handle 90° reversible	4015SG05PM	Chrome	600	450	
		4016SG05PM	Chrome	700	450	
		4017SG05PM	Chrome	700	550	
	Holding handle with vertical support	4020SG05PM	Chrome	450	560	525
		4021SG05PM	Chrome	450	560	775
	Single shower handrail	4025SG05PM	Chrome	660	675	
		4026SG05PM	Chrome	760	775	
	Double shower handrail	4030SG05PM	Chrome	660	1125	
		4031SG05PM	Chrome	760	1125	
	Holding handle with shower holder	4050SG05PM	Chrome	800	880	
		4051SG05PM	Chrome	1000	1080	
	Holding handle 90° with shower holder	4055SG05PM	Chrome	800	600	
		4056SG05PM	Chrome	1000	600	
		4057SG05PM	Chrome	1000	700	
		4059SG05PM	Chrome	1200	700	
	Wall handrail with shower holder	4060SG05PM	Chrome	800	560	525
		4061SG05PM	Chrome	1000	560	525
		4062SG05PM	Chrome	1000	560	775
		4064SG05PM	Chrome	1200	560	775

Plan your bathroom here







Lakes Bathrooms

Alexandra Way
Ashchurch
Tewkesbury
Gloucestershire GL20 8NB

Tel: 01684 853870
Fax: 01684 857411
Enquiries: info@lakesbathrooms.co.uk
Customer Service: custservice@lakesbathrooms.co.uk

www.lakesbathrooms.co.uk

Issue date: January 2018
Stock code: BRLKS-22
© Lakes Bathrooms Limited 2018



**Lakes
Bathrooms**

SUPERIOR AS STANDARD