

VOGUE

UK

TOWEL WARMERS & RADIATORS



lifestyle
luxury



Towel Rails and Radiators
Vogue UK Est^d 1990

be
inspired

VOGUE
TOWEL WARMERS & RADIATORS



Welcome to Vogue UK – the country’s leading manufacturer of heated towel rails, designer radiators and accessories. Established in 1990 within the heart of the West Midlands, and still privately owned by its original founders, Vogue UK continues to design and create more products than any other company in this field, constantly leading the trend by combining fashion with functionality.

Everyone has their own sense of style and that’s why Vogue UK has created a range of products that meet the needs of every interior design style. If you require something unique then our craftsmen can create a design to your exact brief. As Vogue UK have been creating towel rails and designer radiators since 1990 the company has built an extensive portfolio of designs and can offer a bespoke service, ideal if you’re looking to create an authentic period look or simply match an existing design.

Our six categories of products in this brochure and on our website are sure to encompass the perfect design for you..... no matter what shape, style or size you’re looking for.

CONTEMPORARY

LADDER RAILS

TRADITIONAL

DESIGNER RADIATORS

ELECTRIC

ADDITIONS



VOGUE
TOWEL WARMERS & RADIATORS



Bespoke Design & Manufacture Service

‘Liberty to Customise’

If your exact requirements are not illustrated within our literature, we offer a bespoke service. This service allows you to customise your towel rail or radiator dimensions, materials and finishes.

‘Freedom to Realise Your Ideas’

We can work from any design specification and handcraft special products from high quality brass or stainless steel. Our team will offer technical advice to ensure your design is viable before a quote is issued for approval and the product is manufactured.

‘Commissioned Project Expertise’

We are dedicated to combining innovative design with a high level of client services. This collaborative design process involves the active participation of you, our client.

We help clarify visions, execute 3D designs and manufacture the bespoke end product.

Every effort is made to ensure the design process is swift. Vogue UK has extensive experience working with architects, contractors and individuals alike.

Symbols and Product Information

Brass Manufacture



DZR Brass

The highest quality brass available in a finish of your choice. Corrosion resistant and provides a superior plated finish.



A 30 year quality assurance guarantee

On our brass products showing this symbol.



Heating and Hot Water

Suitable for all heating and hot water systems.

Stainless Steel Manufacture



Stainless Steel

Giving an easy to clean finish that is resistant to corrosion and has a high heat output.



A 30 year quality assurance guarantee

On stainless steel products showing this symbol.



Heating and Hot Water

Suitable for all heating and hot water systems.

Mild Steel Manufacture



Mild Steel

Quality mild steel available in chrome and painted finishes suitable for indirect /closed heating systems.



A 15 year quality assurance guarantee

On mild steel products showing this silver symbol.



Heating Only

Suitable for closed indirect heating systems.



A 2 year quality assurance guarantee

On our products showing this symbol.

Additional Requirements



Electric only

Can be specified where this symbol is displayed. Please see page 144 for full range and price supplements.



Heating and Electric

Can be specified where this symbol is displayed. Please see page 144 for full range and price supplements.



Electric Dryline

Can be specified where this symbol is displayed. Dryline technology, heated via a heater cable. POA



Available in RAL colour chart options, where this symbol is displayed. Please see page 150 for colour options and price supplement.

Stock Information



The 'Tick' symbol in the product specification tables denotes a stocked item.



The 'Handprint' symbol in the product specification tables denotes a made to order product.



be
stylish
stylish

VOGUE
UK

Contemporary Towel Rails

For the past 28 years we have been proud to be at the forefront of new designs. Every year we work with interior designers to produce products of style with substance.



CONCERTINA Wall Mounted DR010



VL003



19 + 32mm

For electric element & valve options see pages 144 & 148

Concertina is a beautiful iconic rail. Towels slide easily in from the side and can be left or right hand mounted. Manufactured from high quality mild steel. Prices shown are for chrome finished for central heating models.

Concertina			Dimensions (mm)			Bar config	Pipe Centres	Electric element wattage	Output $\Delta T50^{\circ}\text{C}$ Watts/BTU's	Output $\Delta T60^{\circ}\text{C}$ BTU's	Stock or made to order	
MS	15	C	H	W	D							
			DR010	1000	500	111	12	75	150	226 / 771	978	✓
			DR010	1000	600	111	12	75	200	311 / 1061	1345	✓
			DR010	1200	500	111	14	75	200	383 / 1307	1657	✓
			DR010	1200	600	111	14	75	300	423 / 1443	1830	✓



The Marine's innovative design is a focal point for any bathroom. The looped horizontal rails maximise both heat output and hanging space. Manufactured from high quality mild steel. Prices shown are for chrome finished for central heating models.



VL003



19 + 32mm



For electric element & valve options see pages 144 & 148

Marine			Dimensions (mm)			Bar config	Pipe centres	Electric element wattage	Output $\Delta T50^{\circ}C$ Watts/BTU's	Output $\Delta T60^{\circ}C$ BTU's	Stock or made to order
MS	15	C	H	W	D						
DR009	1400	600	177	25	110	400	767 / 2617	3318	✓		



Cygnus is handsome and highly practical. The looped horizontal rails maximise both heat output and hanging space. Finished in chrome. Manufactured from high quality mild steel. Prices shown are chrome finish for central heating models.



VL003



19 + 32mm

For electric element & valve options see pages 144 & 148

Mild Steel Metallic Finish Supplements

Gold - POA

Bright Nickel - Chrome - POA

Cygnus			Dimensions (mm)			Bar config	Pipe centres	Electric element wattage	Output $\Delta T50^{\circ}\text{C}$ Watts/BTU's	Output $\Delta T60^{\circ}\text{C}$ BTU's	Stock or made to order	
MS	15	C	H	W	D							
			DR012	900	500	170	4-4-10	300	150	417 / 1423	1804	✓
			DR012	1200	500	170	4-4-4-11	300	200	556 / 1897	2405	✓



New for 2019



VL003



19 + 32mm

For other valve options see page 148

A unique looped rail encompassing a vertical contemporary radiator adds a beautifully smooth and contemporary feel to any space. The coiled bars bring an intricacy whilst providing abundant towel hanging space. Finished in chrome. Manufactured from high quality mild steel. Prices shown are chrome finish for central heating models.

Cygnus Harmonique			Dimensions (mm)			Bar config	Pipe centres	Electric element wattage	Output $\Delta T50^{\circ}C$ Watts/BTU's	Output $\Delta T60^{\circ}C$ BTU's	Stock or made to order
MS	15	C	H	W	D						
DR032	1200	500	159-174	23	300	400	726 / 2477	3141	✓		

DRACO Wall Mounted DR015



Draco's equally spaced hooped tubes form an architectural shape. Perfect symmetry with centralised valves. Finished in chrome, a must for any modern setting. Manufactured from high quality mild steel. Prices shown are chrome finish for central heating models.



VL014



Ø 19mm

30 x 30mm

For electric element & valve options see pages 144 & 148

Mild Steel Metallic Finish Supplements

Gold - POA

Bright Nickel - Chrome - POA

Draco			Dimensions (mm)			Bar config	Pipe centres	Electric element wattage	Output Δ T50°C Watts/BTU's	Output Δ T60°C BTU's	Stock or made to order
MS	15	C	H	W	D						
DR015	1000	500	160	9	86	125	236 / 805	1021	✓		
DR015	1300	500	160	13	86	150	272 / 928	1177	✓		



When space is limited... You still want good design and high heat output, the Intra ticks all the boxes. The towel rail fits neatly into a corner to maximise wall space and is available in two sizes. Manufactured from large diameter brass or mild steel tube and chromed to a mirror finish. Bespoke finishes are available at an additional cost. Please see pages 150 & 151 for finishes and colour options. Prices shown are chrome finished for central heating systems. Colour options for brass models only.



VL003



31.8 + 50.8mm

For electric element & valve options see pages 144 & 148

Mild Steel Metallic Finish Supplements

Gold - POA

Bright Nickel - Chrome - POA

Brushed Nickel - Chrome - POA

Intra			Dimensions (mm)			Bar config	Pipe Centres	Electric element wattage	Output $\Delta T50^{\circ}\text{C}$ Watts/BTU's	Output $\Delta T60^{\circ}\text{C}$ BTU's	Stock or made to order
MS	15	C	H	W	D						
CN013-MS	1240	556	306	5-5-5	281 + 531	200	525 / 1791	2271	✓		
CN013-MS	1680	556	306	5-5-5-5	281 + 531	300	703 / 2399	3042	✓		
Intra			Dimensions (mm)			Bar config	Pipe Centres	Electric element wattage	Output $\Delta T50^{\circ}\text{C}$ Watts/BTU's	Output $\Delta T60^{\circ}\text{C}$ BTU's	Stock or made to order
BR	30	H	H	W	D						
CN013	1240	500	350	5-5-5	325 + 475	200	607 / 2071	2626	✎		
CN013	1680	500	350	5-5-5-5	325 + 475	300	814 / 2777	3521	✎		

FLEXX Wall Mounted CN015



Please note: Electric and dual energy versions come with a straight bottom bar.

Flex is sensual and curvaceous. This handcrafted towel rail is an original design, with all the functionality a fabulous towel rail must have. Manufactured by craftsmen in high quality brass tube, chromed to a mirror finish. Please see pages 150 & 151 for finishes and colour options. Prices shown are chrome finished for all heating and hot water systems.



VL003



31.8 + 50.8mm

For electric element & valve options see pages 144 & 148

Flex			Dimensions (mm)			Bar config	End to End Connections	Electric element wattage	Output $\Delta T50^{\circ}\text{C}$ Watts/BTU's	Output $\Delta T60^{\circ}\text{C}$ BTU's	Stock or made to order
BR	30	H	H	W	D						
CN015			1240	540	250	15	540	300	642 / 2191	2778	



New for 2019

A simple yet sophisticated piece. With chunky tube creating a robust and full bodied appeal, the Mantra V will add a high quality and classy statement to your bathroom or en suite. Chromed to a mirror finish. Prices shown are chrome finished for all heating and hot water systems.



VL003



32 + 51mm

For electric element & valve options see pages 144 & 148

Mantra V			Dimensions (mm)			Bar config	Pipe centres	Electric element wattage	Output $\Delta T50^{\circ}\text{C}$ Watts/BTU's	Output $\Delta T60^{\circ}\text{C}$ BTU's	Stock or made to order
MS	15	C	H	W	D						
CN075			1240	500	125	14	449	200	408 / 1392	1765	✓

PURE Wall Mounted MD037



Pure high quality elegance. This handcrafted towel rail is manufactured in brass and chromed to a mirror finish. Bespoke finishes are available at an additional cost. A perfect size for smaller areas where space is at a premium and quality a must. Please see pages 150 & 151 for finishes and colour options. Prices shown are chrome finished for heating and hot water systems.



VL003



25.4 + 19mm

For electric element & valve options see pages 144 & 148

Pure		Dimensions (mm)			Bar config	Pipe Centres	Electric element wattage	Output $\Delta T50^{\circ}\text{C}$ Watts/BTU's	Output $\Delta T60^{\circ}\text{C}$ BTU's	Stock or made to order
BR	30	H	W	D						
MD037		700	425	75	4	400	75	106 / 362	459	

Understated with great towel hanging functionality, Grace is the epitome of simple chic design.

Manufactured from large diameter high quality mild steel. Prices shown are chrome finished for central heating models.



Mild Steel Metallic Finish Supplements

Gold - POA

Bright Nickel - Chrome - POA

Brushed Nickel - Chrome - POA



VL003



For electric element & valve options see pages 144 & 148

Grace			Dimensions (mm)			Bar config	Pipe centres	Electric element wattage	Output $\Delta T50^{\circ}\text{C}$ Watts/BTU's	Output $\Delta T60^{\circ}\text{C}$ BTU's	Stock or made to order
MS	15	C	H	W	D						
	MD067		800	500	100	3	462	100	140 / 478	606	✓
	MD067		1200	500	100	4	462	125	199 / 679	861	✓

SMOOTH Wall Mounted CN035



Smooth combines excellent towel hanging space with high heat output and eye catching design.

Manufactured from high quality mild steel. Prices shown are chrome finished for central heating systems models.

Mild Steel Metallic Finish Supplements

Gold - POA

Bright Nickel - Chrome - POA

Brushed Nickel - Chrome - POA



VL003



32 + 22mm

For electric element & valve options see pages 144 & 148

MS	15	C	Smooth			Dimensions (mm)			Bar config	Pipe centres	Electric element wattage	Output $\Delta T50^{\circ}\text{C}$ Watts/BTU's	Output $\Delta T60^{\circ}\text{C}$ BTU's	Stock or made to order
			H	W	D	H	W	D						
			800	400	94	9	368	100	163 / 556	705	✓			
			800	500	94	9	468	125	189 / 645	818	✓			
			1200	400	94	13	368	150	235 / 802	1017	✓			
			1200	500	94	13	468	150	271 / 925	1173	✓			

Smooth II is modern and stylish, featuring 38mm vertical tubes. Manufactured from high quality mild steel with mitred corners. Prices shown are chrome finished for central heating systems.



Mild Steel Metallic Finish Supplements

Gold - POA

Bright Nickel - Chrome - POA

Brushed Nickel - Chrome - POA



VL003



38 + 32mm

For electric element & valve options see pages 144 & 148

Smooth II			Dimensions (mm)			Bar config	Pipe centres	Electric element wattage	Output $\Delta T50^{\circ}\text{C}$ Watts/BTU's	Output $\Delta T60^{\circ}\text{C}$ BTU's	Stock or made to order
MS	15	C	H	W	D						
			800	400	96	8	368	125	206 / 703	891	✓
			800	500	96	8	468	150	237 / 809	1026	✓
			1200	400	96	11	368	200	292 / 996	1263	✓
			1200	500	96	11	468	200	335 / 1143	✓1449	

CHIC Wall Mounted MD046



Chic gives ultimate versatility allowing towels to be accessed from the side. This practical and stylish design is available chrome plated or in white. Manufactured from high quality mild steel which can be mounted to the left or right. Prices shown are chrome or white finished for central heating models.

Mild Steel Metallic Finish Supplements

Gold - POA

Bright Nickel - Chrome - POA

Brushed Nickel - Chrome - POA



VL014



Ø
22mm
□
30mm

For electric element & valve options see pages 144 & 148

Chic		Dimensions (mm)			Bar config	Pipe centres	Electric element wattage	Output $\Delta T50^{\circ}\text{C}$ Watts/BTU's		Output $\Delta T60^{\circ}\text{C}$ BTU's		Stock or made to order
MS	15	C	H	W				D	chrome	white	chrome	
MD046	1200	500	85	3-3-3-3-3	100	150	282 / 962	377 / 1286	1220	1631	✓	



Mild Steel Metallic Finish Supplements

- Gold - POA
- Bright Nickel - Chrome - POA
- Brushed Nickel - Chrome - POA

A contemporary, minimalist design with crisp clean lines. Keys II allows towels to be effortlessly hung onto the rails from the left or right hand side, depending on your requirements. Manufactured from high quality mild steel, chromed to a mirror finish. Prices shown are for central heating models. Stainless Steel version available on request



VL014



30sq + 40sq mm

For electric element & valve options see pages 144 & 148

Keys II			Dimensions (mm)			Bar config	Pipe Centres	Electric element wattage	Output $\Delta T50^{\circ}\text{C}$ Watts/BTU's	Output $\Delta T60^{\circ}\text{C}$ BTU's	Stock or made to order
MS	15	C	H	W	D						
CN030	1080	500	141	6	50	150	392 / 1338	1697	✓		
CN030	1460	500	141	8	50	200	524 / 1788	2267	✓		
CN030	1840	500	141	10	50	300	656 / 2238	2838	✓		

ZENITH Wall Mounted IN007



VL003



40sq + 30sq mm

For electric element & valve options see pages 144 & 148

Zenith is manufactured in stainless steel and has a brushed or polished finish, suitable for all heating & hot water systems. Please see page 150 for colour options

Zenith			Dimensions (mm)			Bar config	Pipe centres	Electric element wattage	Output $\Delta T50^{\circ}\text{C}$ Watts/BTU's	Output $\Delta T60^{\circ}\text{C}$ BTU's	Stock or made to order
SS	30	H	H	W	D						
IN007			1200	400	90	6	360	125	421 / 1436	1821	

A few examples of the colours available



RAL 5009



RAL 3020



RAL 6027



RAL 4005



Moda is manufactured from high quality mild steel and finished in polished chrome with a white integral radiator. Please see pages 150 & 151 for finishes and colour options.



VL003



40sq + 40 x 20mm

For electric element & valve options see pages 144 & 148

Mild Steel Metallic Finish Supplements

- Gold - POA
- Bright Nickel - Chrome - POA
- Brushed Nickel - Chrome - POA

Moda			Dimensions (mm)			Bar config	Pipe centres	Electric element wattage	Output $\Delta T50^{\circ}C$ Watts/BTU's	Output $\Delta T60^{\circ}C$ BTU's	Stock or made to order
MS	15	C	H	W	D						
CN001	1200	500	150	5	310	300	787 / 2685	3405			

VISTA Wall Mounted IN002



Vista is sculptural with beautifully finished tactile edges. Manufactured from stainless steel and has a brushed or polished finish. Available in three lengths from 500mm, ideal for ensuites to 1500mm, perfect above a bath. Stainless steel suitable for all hot water systems. Please see page 150 for colour options



VL003



40sq mm

For electric element & valve options see pages 144 & 148

Vista			Dimensions (mm)			Bar config	End to End Connections	Electric element wattage	Output $\Delta T50^{\circ}\text{C}$ Watts/BTU's	Output $\Delta T60^{\circ}\text{C}$ BTU's	Stock or made to order
SS	30	H	W	D							
			140	500	90	2	500	75	118 / 403	511	
			140	1000	90	2	1000	100	223 / 761	965	
			140	1500	90	2	1500	125	328 / 1119	1419	



Simple and beautiful, this design comes in three different widths, the 500mm shortest width is perfect for areas where space is at a premium. Manufactured from high quality mild steel, chromed to a mirror finish. Prices shown are for central heating models. Please see pages 150 & 151 for finishes and colour options. Prices shown are chrome finished for heating and hot water systems.



VL003



40sq mm

For electric element & valve options see pages 144 & 148

Mild Steel Metallic Finish Supplements

Gold - POA

Bright Nickel - Chrome - POA

Brushed Nickel - Chrome - POA

Memo		Dimensions (mm)			Bar config	End to End Connections	Electric element wattage	Output $\Delta T50^{\circ}\text{C}$ Watts/BTU's	Output $\Delta T60^{\circ}\text{C}$ BTU's	Stock or made to order	
MS	15	C	H	W							D
			140	500	90	2	500	75	86 / 293	372	
			140	1000	90	2	1000	100	171 / 583	739	
			140	1500	90	2	1500	125	256 / 873	1107	

QUADRATE Wall Mounted MD074



Quadrate has 50mm vertical tubes and crisp, sleek edges, which would suit any modern bathroom setting. Available in a range of heights and widths. Manufactured from high quality mild steel. Prices are for chrome central heating models.

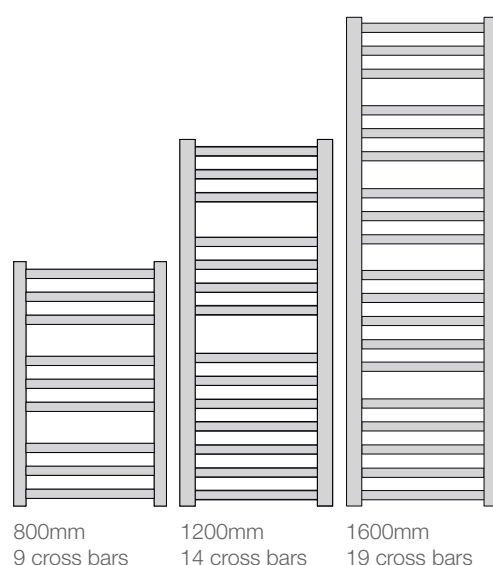

Mild Steel Metallic Finish Supplements

Gold - POA

Bright Nickel - Chrome - POA

Brushed Nickel - Chrome - POA



VL014



50sq + 30sq mm

For electric element & valve options see pages 144 & 148

Quadrate			Dimensions (mm)			Bar config	Pipe centres	Electric element wattage	Output $\Delta T50^{\circ}\text{C}$ Watts/BTU's	Output $\Delta T60^{\circ}\text{C}$ BTU's	Stock or made to order	
MS	15	C	H	W	D							
			MD074	800	500	105	3-3-3	450	150	271 / 925	1173	✓
			MD074	800	600	105	3-3-3	550	200	310 / 1058	1342	✓
			MD074	1200	500	105	3-4-7	450	300	416 / 1419	1799	✓
			MD074	1200	600	105	3-4-7	550	300	477 / 1628	2064	✓
			MD074	1600	500	105	3-3-3-5-5	450	400	561 / 1914	2427	✓
			MD074	1600	600	105	3-3-3-5-5	550	600	645 / 2201	2791	✓

A strikingly functional product that packs a punch with a high heat output, multiple crossbars for optimum towel hanging capabilities and a chic double panel radiator. The square tubing presents a fresh, contemporary feel for a bold and clean profile. Finished in chrome. Manufactured from high quality mild steel. Prices shown are chrome finish for central heating models.



VL014



50sq + 30sq mm

For electric element & valve options see pages 144 & 148



New for 2019

Quadrates Harmonique			Dimensions (mm)			Bar config	Pipe centres	Electric element wattage	Output $\Delta T50^{\circ}C$ Watts/BTU's	Output $\Delta T60^{\circ}C$ BTU's	Stock or made to order
MS	15	C	H	W	D						
MD078			1200	500	105-120	7	450	400	1003 / 3422	4339	✓

RUBIK Wall Mounted MD038



Simple and beautiful, the rectangular stainless steel tube is built to last. The Rubik comes in polished stainless steel as standard. Please see pages 150 & 151 for finishes and colour options.

Stainless steel construction suitable for all hot water systems

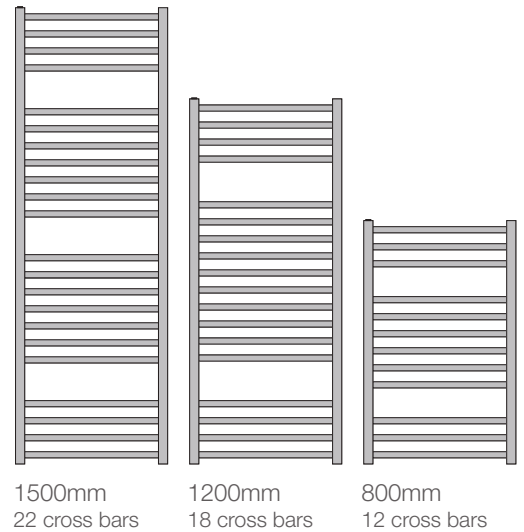

VL014



30sq + 20sq mm

For electric element & valve options see pages 144 & 148

Rubik			Dimensions (mm)			Bar config	Pipe Centres	Electric element wattage	Output Δ T50°C Watts/BTU's	Output Δ T60°C BTU's	Stock or made to order
SS	30	H	H	W	D						
		MD038	800	500	80	3-6-3	470	200	404 / 1378	1747	
		MD038	1200	500	80	4-10-4	470	300	607 / 2071	2626	
		MD038	1500	500	80	4-7-7-4	470	300	747 / 2549	3232	

Modern looks from this square tubed design brings together aesthetics and practicality. This versatile product will suit any modern bathroom. Chromed to a mirrored or anthracite finish. Prices shown are for central heating models.

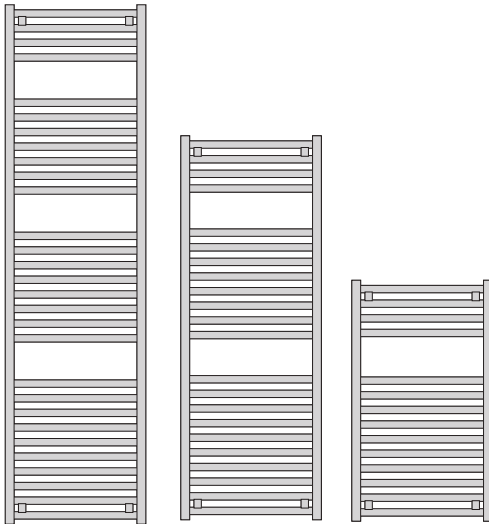

1770mm
29 cross bars

1322mm
22 cross bars

830mm
14 cross bars



Anthracite Textured finish option

Mild Steel Metallic Finish Supplements

Gold - POA

Bright Nickel - Chrome - POA

Brushed Nickel - Chrome - POA



VL014



30sq + 25sq mm









For electric element & valve options see pages 144 & 148



Squire	Dimensions (mm)			Bar config	Pipe centres	Electric element wattage	Output Δ T50°C Watts/BTU's		Output Δ T60°C BTU's		Stock or made to order			
	MS	15	C				H	W	D	chrome		painted	chrome	painted
MD047				830	480	90	4-10	450	150	278 / 949	416 / 1419	1203	1799	✓
MD047				830	580	90	4-10	550	200	331 / 1129	495 / 1689	1432	2142	✓
MD047				1322	480	90	4-8-10	450	300	440 / 1501	656 / 2238	1903	2838	✓
MD047				1322	580	90	4-8-10	550	300	523 / 1784	780 / 2661	2262	3374	✓
MD047				1770	480	90	4-7-8-10	450	400	581 / 1982	868 / 2962	2513	3756	✓
MD047				1770	580	90	4-7-8-10	550	600	691 / 2358	1032 / 3521	2990	4465	✓

SERENE Wall Mounted MD049

Contemporary Finishes

-  Latte Textured
-  Cappuccino Textured
-  Mocha Textured
-  Espresso Gloss
-  Anthracite Textured
-  Satin Black
-  Matt Black
-  White Sparkle
-  Grey Sparkle



The Serene is just that. A well balanced design which maximises hanging space. A perfect towel warmer for contemporary kitchens and bathrooms alike. Square tubes finished with a choice of chrome or contemporary finishes. Please see page 150 for other colour options. Prices shown are for central heating models.

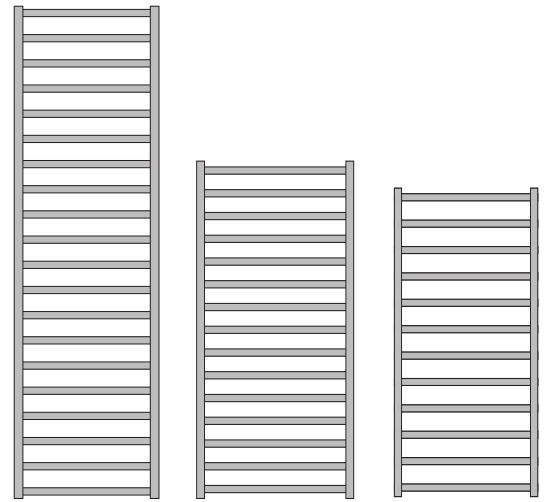

1700mm 20 cross bars 1165mm 15 cross bars 1000mm 12 cross bars

Mild Steel Metallic Finish Supplements

- Gold - POA
- Bright Nickel - Chrome - POA
- Brushed Nickel - Chrome - POA



VL014



25sq + 30sq mm

For electric element & valve options see pages 144 & 148

Serene		Dimensions (mm)			Bar config	Pipe centres	Electric element wattage	Output $\Delta T50^{\circ}\text{C}$ Watts/BTU's		Output $\Delta T60^{\circ}\text{C}$ BTU's		Stock or made to order
		H	W	D				chrome	painted	chrome	painted	
MS	15	C										
MD049	1000	500	85	12	470	150	257 / 877	409 / 1396	1112	1770	✓	
MD049	1165	500	85	15	470	200	314 / 1071	420 / 1433	1358	1817	✓	
MD049	1165	600	85	15	570	300	365 / 1245	437 / 1491	1579	1891	✓	
MD049	1700	500	85	20	470	300	434 / 1481	501 / 1709	1878	2167	✓	
MD049	1700	600	85	20	570	400	520 / 1774	601 / 2051	2249	2601	✓	

A contemporary, minimalist design. With crisp edges and clean lines. The Ideal is manufactured in high quality stainless steel which is polished to perfection.

Stainless steel construction is suitable for all hot water systems.

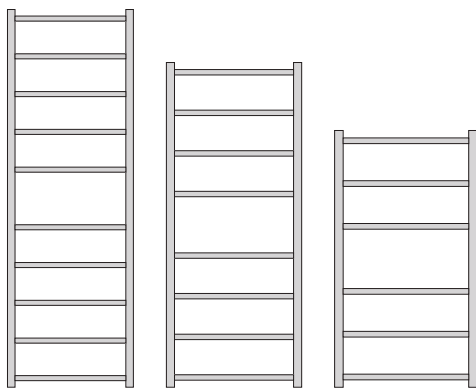

1500mm 10 cross bars
 1200mm 8 cross bars
 900mm 6 cross bars



VL014



30sq + 20sq mm

For electric element & valve options see pages 144 & 148

Ideal		Dimensions (mm)			Bar config	Pipe Centres	Output $\Delta T50^{\circ}\text{C}$ Watts/BTU's	Output $\Delta T60^{\circ}\text{C}$ BTU's	Electric element wattage	Stock or made to order
SS	30	H	W	D						
		900	500	100	6	470	281 / 959	1216	100	✓
		1200	500	100	8	470	375 / 1280	1623	125	✓
		1500	500	100	10	470	469 / 1600	2029	150	✓

BOXA Wall Mounted CN009



Boxa is crafted using large gauge square and rectangular tubing and has smooth rounded corners. A perfect blend of form and function. There are two options, polished stainless steel or chromed mild steel. Available in three heights to suit the size of your room.

Prices shown are for chrome and polished stainless steel models. Please see pages 150 & 151 for finishes and colour options.

Mild Steel Metallic Finish Supplements

Gold - POA

Bright Nickel - Chrome - POA

Brushed Nickel - Chrome - POA



VL014



40sq +
40 x 20mm

For electric element & valve options see pages 144 & 148

Boxa		Dimensions (mm)			Bar config	Pipe centres	Electric element wattage	Output $\Delta T50^{\circ}\text{C}$ Watts/BTU's	Output $\Delta T60^{\circ}\text{C}$ BTU's	Stock or made to order
MS	15	C	H	W						
CN009A - MS	620	450	120	3	410	100	199 / 679	861	✓	
CN009B - MS	1060	450	120	5	410	150	290 / 989	1254	✓	
CN009C - MS	1500	450	120	7	410	150	437 / 1491	1891	✓	

Boxa		Dimensions (mm)			Bar config	Pipe centres	Electric element wattage	Output $\Delta T50^{\circ}\text{C}$ Watts/BTU's	Output $\Delta T60^{\circ}\text{C}$ BTU's	Stock or made to order
SS	30	H	W	D						
CN009A - SS	620	450	120	3	410	100	199 / 679	861	✎	
CN009B - SS	1060	450	120	5	410	125	290 / 989	1254	✎	
CN009C - SS	1500	450	120	7	410	200	437 / 1491	1891	✎	

Arc has it all, ample towel hanging space and good heat output. Available in chrome to suit your ideal kitchen or bathroom. Manufactured from high quality mild steel. Prices shown are for central heating models in a chrome finish.



Unique bar design

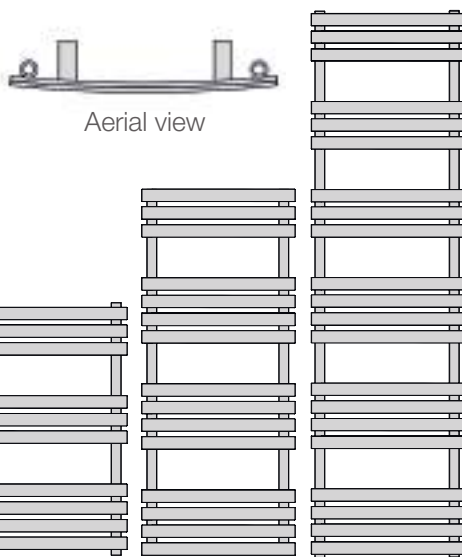

828mm 1200mm 1800mm
10 cross bars 15 cross bars 21 cross bars

Mild Steel Metallic Finish Supplements

Gold - POA

Bright Nickel - Chrome - POA



VL014



32mm

40 x 18mm

For electric element & valve options see pages 144 & 148



Arc	Dimensions (mm)			Bar config	Pipe centres	Electric element wattage	Output $\Delta T50^{\circ}\text{C}$ Watts/BTU's	Output $\Delta T60^{\circ}\text{C}$ BTU's	Stock or made to order
	MS	15	C						
MD065				3-3-4	430	150	232 / 792	1004	✓
MD065				3-4-4-4	430	300	346 / 1181	1498	✓
MD065				3-3-3-4-4-4	430	400	491 / 1675	2124	✓

GALLANT Wall Mounted MD040SS



Crafted in high quality stainless steel. The Gallant is a bold stylish piece offering crisp right angles to stunning effect. Available in two heights in polished stainless steel, suitable for all hot water systems.

Please see page 150 for colour options

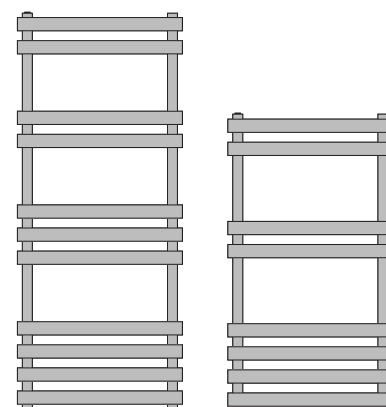

1200mm
11 cross bars

900mm
8 cross bars







VL014



30sq + 40 x 20sq mm

For electric element & valve options see pages 144 & 148

  	Gallant			Dimensions (mm)			Bar config	Pipe Centres	Electric element wattage	Output $\Delta T50^{\circ}\text{C}$ Watts/BTU's	Output $\Delta T60^{\circ}\text{C}$ BTU's	Stock or made to order
	H	W	D									
	MD040SS	900	500	97	2-2-4	440	200	458 / 1563	1982			
	MD040SS	1200	500	97	2-2-3-4	440	300	624 / 2129	2700			

The square tubed design brings together aesthetics and practicality. This versatile product will suit any modern bathroom. Chromed to a mirrored finish. Prices shown are for central heating models.

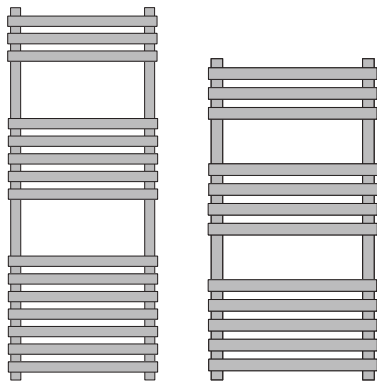

1270mm
15 cross bars

970mm
12 cross bars

Mild Steel Metallic Finish Supplements

- Gold - POA
- Bright Nickel - Chrome - POA
- Brushed Nickel - Chrome - POA



VL003



35mm
35 x 20mm

For electric element & valve options see pages 144 & 148

Gallant II			Dimensions (mm)			Bar config	Pipe Centres	Electric element wattage	Output $\Delta T50^{\circ}\text{C}$ Watts/BTU's	Output $\Delta T60^{\circ}\text{C}$ BTU's	Stock or made to order
MS	15	C	H	W	D						
			970	500	132	3-4-5	450	200	296 / 1010	1281	✓
			1270	500	132	3-5-7	450	300	363 / 1239	1571	✓

AQUILA Wall Mounted DR016

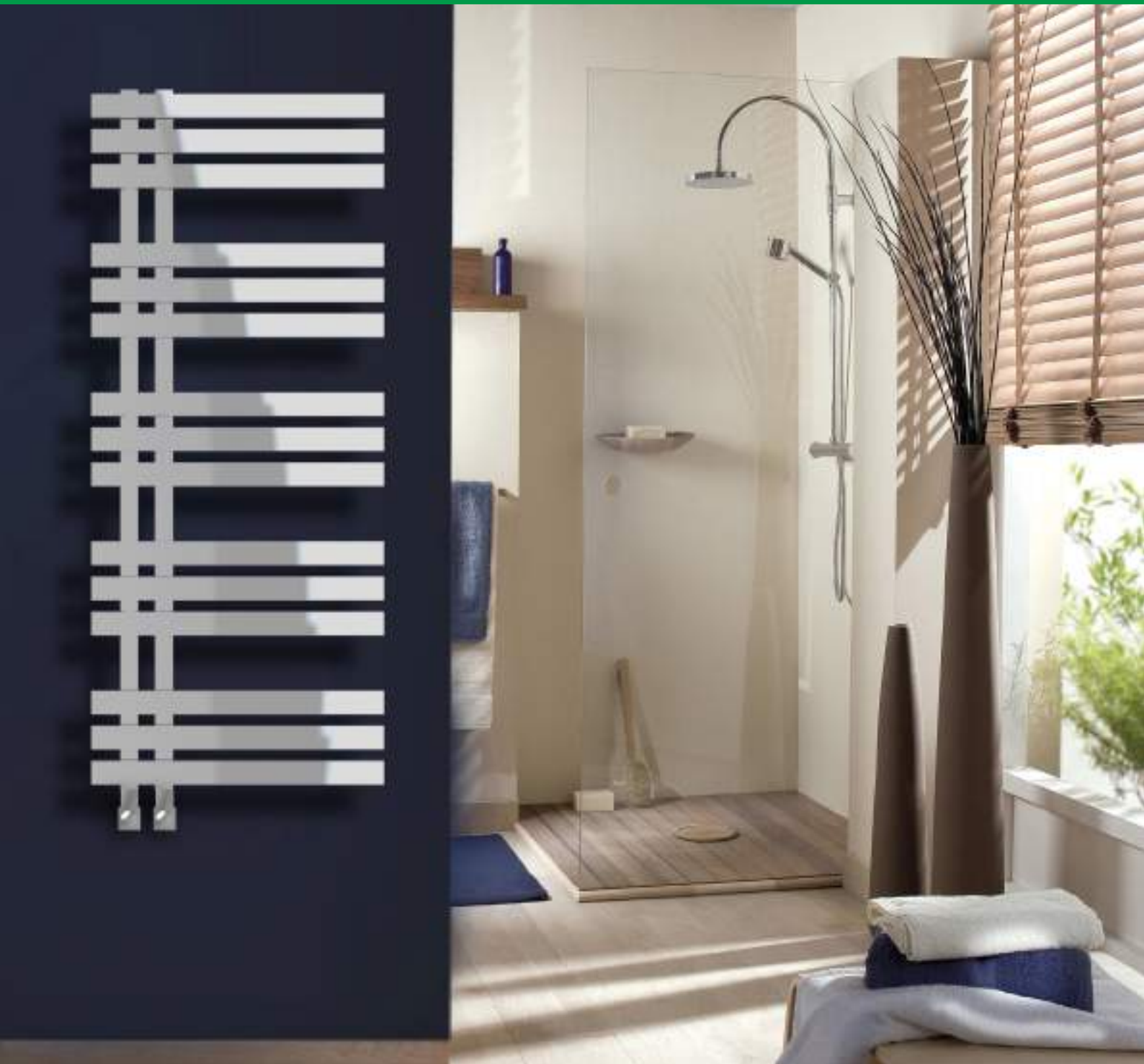

Rectangular tube towel rail provides ample space and heat for warming or drying towels, in a design which allows you to slide them effortlessly into place from either the left or right, depending on your preference.

Manufactured from high quality mild steel, prices shown are chrome finished for central heating models.



VL014



40 x 10 + 30 x 30mm

For electric element & valve options see pages 144 & 148

Aquila			Dimensions (mm)			Bar config	Pipe centres	Electric element wattage	Output $\Delta T50^{\circ}\text{C}$ Watts/BTU's	Output $\Delta T60^{\circ}\text{C}$ BTU's	Stock or made to order	
MS	15	C	H	W	D							
			DR016	1200	500	118	3-3-3-3-3	60	150	354 / 1208	1532	✓
			DR016	1400	600	118	3-3-3-3-3-3	60	200	436 / 1488	1887	✓



Asymmetric rectangular tube towel rails give a fascinating design that has clean lines and simple access from either side. Manufactured from high quality mild steel, prices shown are chrome finished for central heating models.



VL014



40 x 10 + 30 x 30mm

For electric element & valve options see pages 144 & 148

Phoenix			Dimensions (mm)			Bar config	Pipe centres	Electric element wattage	Output $\Delta T50^{\circ}\text{C}$ Watts/BTU's	Output $\Delta T60^{\circ}\text{C}$ BTU's	Stock or made to order
MS	15	C	H	W	D						
DR017	1200	500	118	3-3-3-3-3	60	150	301 / 1027	1302	✓		

CURVEE Wall Mounted MD050

Curvee is stylish and practical. As the name suggests the cross rails are gently bowed. The towel rail offers good heat output in four sizes, the 800mm version is pictured. Available in chrome or white finish. Please see page 150 for colour options. Prices shown are chrome finished for central heating models.

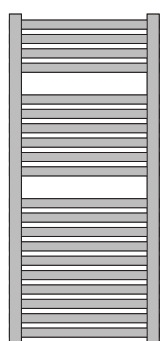

1100mm
20 cross bars

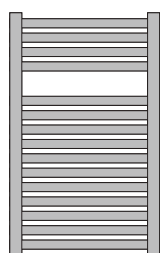

800mm
15 cross bars

Curved Bars



Mild Steel Metallic Finish Supplements

- Gold - POA
- Brushed Gold - POA
- Bright Nickel - Chrome - POA
- Brushed Nickel - Chrome - POA



VL003  15 x 30 + 30 x 40mm

For electric element & valve options see pages 144 & 148

Curvee	Dimensions (mm)			Bar config	Pipe centres	Electric element wattage	Output		Output		Stock or made to order			
	MS	15	C				H	W	D	Δ T50°C Watts/BTU's		Δ T60°C BTU's		
										chrome		painte	chrome	painte
MD050				800	500	96	4-11	455	125	235 / 802	543 / 1853	1017	2350	✓
MD050				800	600	96	4-11	555	150	274 / 935	556 / 1897	1186	2405	✓
MD050				1100	500	96	4-6-10	455	200	316 / 1078	583 / 1989	1367	2522	✓
MD050				1100	600	96	4-6-10	555	300	387 / 1320	587 / 2003	1674	2540	✓



Rectangular crossbars give a solid feel to this design. Available in two sizes finished in your choice of chrome, white or a contemporary colour of your choice from the swatches (above). Prices shown are for central heating models. Please see page 150 for other colour options.

Mild Steel Metallic Finish Supplements

- Gold - POA
- Bright Nickel - Chrome - POA
- Brushed Nickel - Chrome - POA



VL003



Ø 38mm
□ 60 x 10mm

For electric element & valve options see pages 144 & 148

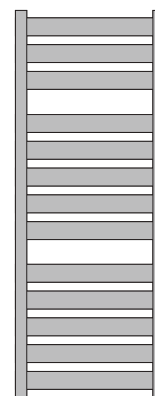

1300mm
13 cross bars

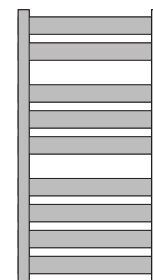

950mm
9 cross bars

Vela MS 15 C	Dimensions (mm)			Bar config	Pipe centres	Electric element wattage	Output Δ T50°C Watts/BTU's		Output Δ T60°C BTU's		Stock or made to order
	H	W	D				chrome	paintd	chrome	paintd	
MD048	950	500	101	2-3-4	462	125	246 / 839	289 / 986	1064	1250	✓
MD048	1300	500	101	3-5-5	462	200	330 / 1126	389 / 1327	1428	1683	✓



A memorable design, available in two sizes. Suitable for any modern bathroom. Chromed to a mirror finish. Prices shown are for central heating models.



VL003



40 x 20 + 40 x 10mm

For other valve options see page 148

Mild Steel Metallic Finish Supplements

Gold - POA

Bright Nickel - Chrome - POA

Brushed Nickel - Chrome - POA

Décor		Dimensions (mm)			Bar config	Face to Face connections	Output $\Delta T50^{\circ}\text{C}$ Watts/BTU's	Output $\Delta T60^{\circ}\text{C}$ BTU's	Stock or made to order	
MS	15	C	H	W						D
	MD084		750	450	145	4	388	129 / 440	558	✓
	MD084		1200	450	145	6	388	199 / 679	861	✓



New for 2019



VL003



40 x 20 + 40 x 18mm

For electric element & valve options see pages 144 & 148

Our Décor Harmonique - style combination towel warmer, with flat horizontal bars and a contemporary double panel radiator designed for high heat output. It's modern sleek looks bring an air of sophistication to any setting. Manufactured from high quality mild steel in a chrome finish. Prices shown are chrome finish for central heating models.

Décor Harmonique		Dimensions (mm)			Bar config	Face to Face connections	Electric element wattage	Output $\Delta T50^{\circ}C$ Watts/BTU's	Output $\Delta T60^{\circ}C$ BTU's	Stock or made to order
MS	15	C	H	W						
MD094	1200	500	159	4	442	200	842 / 2873	3643	✓	

UNIQUE Wall Mounted CN028



Contemporary Towel Warmer with cylindrical features. Made from high quality mild steel. Prices shown are chrome finished for central heating models.



VL003



For electric element & valve options see pages 144 & 148

Mild Steel Metallic Finish Supplements

- Gold - POA
- Bright Nickel - Chrome - POA
- Brushed Nickel - Chrome - POA

Unique			Dimensions (mm)			Bar config	Pipe centres	Electric element wattage	Output $\Delta T50^{\circ}\text{C}$ Watts/BTU's	Output $\Delta T60^{\circ}\text{C}$ BTU's	Stock or made to order
MS	15	C	H	W	D						
CN028	950	500	90	4	460	125	155 / 529	671	✓		

Venture is available in three widths and four heights, with spacious hanging bars. The bold jointed design suits contemporary interiors. Manufactured from high quality brass, chromed to a mirror finish. Please see pages 150 & 151 for finishes and colour options.



VL003



25.4 + 22mm



Romolo Joint

For electric element & valve options see pages 144 & 148

Venture			Dimensions (mm)			Bar config	Pipe Centres	Electric Element Wattage	Output $\Delta T50^{\circ}\text{C}$ Watts/BTU's	Output $\Delta T60^{\circ}\text{C}$ BTU's	Stock or made to order	
BR	30	H	H	W	D							
			CN022	750	450	95	4	400	75	121 / 413	524	✓
			CN022	850	650	95	4	600	100	157 / 536	680	✎
			CN022	1300	500	95	6	450	125	206 / 703	891	✎
			CN022	1300	650	95	6	600	125	240 / 819	1038	✎
			CN022	1600	500	95	8	450	150	267 / 911	1155	✎
			CN022	1600	650	95	8	600	150	312 / 1065	1350	✎

VIVID Wall Mounted CN021



Vivid is a beautiful minimalistic towel warmer, manufactured from high quality brass. Prices shown are for chrome heating and hot water systems. Please see pages 150 & 151 for finishes and colour options.



Mitred Joint



VL003



25.4 +
22mm

For electric element & valve options see pages 144 & 148

BR	30	H	Dimensions (mm)			Bar config	Pipe Centres	Electric Element Wattage	Output $\Delta T50^{\circ}\text{C}$ Watts/BTU's	Output $\Delta T60^{\circ}\text{C}$ BTU's	Stock or made to order
			H	W	D						
CN021			750	450	93	4	400	75	121 / 413	524	✓
CN021			800	650	93	4	600	100	154 / 525	666	✎
CN021			1250	500	93	6	450	125	201 / 686	870	✓
CN021			1250	650	93	6	600	125	235 / 802	1017	✎
CN021			1550	500	93	8	450	150	258 / 880	1116	✎
CN021			1550	650	93	8	600	150	303 / 1034	1311	✎



Standard installation with visible valve.



Integral valve is hidden within the towel rail.

INTEGRAL COLLECTION VALVE FITTING

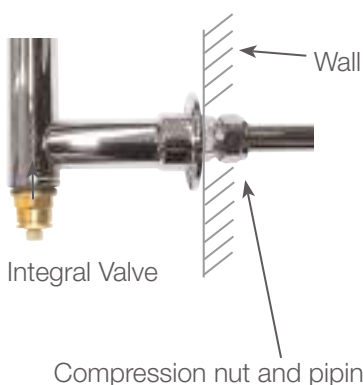

Vivid IV has all the stunning looks of Vivid with the added feature of built in integral valves. Manufactured from high quality brass with a chrome mirror finish. Prices shown are for chrome heating and hot water systems. This radiator is also available on previous page with standard valves. Please see pages 150 & 151 for finishes and colour options. Pipe work is hidden in the wall. Supplied with service valves, which must be fitted on installation . Not suitable for brick walls.



Vivid Integral Valve BR 30 H	Dimensions (mm)			Bar config	Pipe centres	Output Δ T50°C Watts/BTU's	Output Δ T60°C BTU's	Stock or made to order
	H	W	D					
IVCN021	700	500	94	4	450	138 / 471	597	
IVCN021	1100	500	94	5	450	189 / 645	818	
IVCN021	1400	500	94	6	450	232 / 792	1004	

VIVID INTEGRAL VALVE Wall Mounted IVCN021



Vivid IV 400 x 1200 is the ideal choice over a bath or underneath a window. The single bar versions are perfect for en-suites and small spaces. Manufactured from high quality brass with built in valves. Prices shown are chrome finished for all heating and hot water systems. Please see pages 150 & 151 for finishes and colour options. Pipe work is hidden in the wall. Supplied with service valves, which must be fitted on installation. Not suitable for brick walls.



Single Towel Bar option

INTEGRAL COLLECTION VALVE FITTING

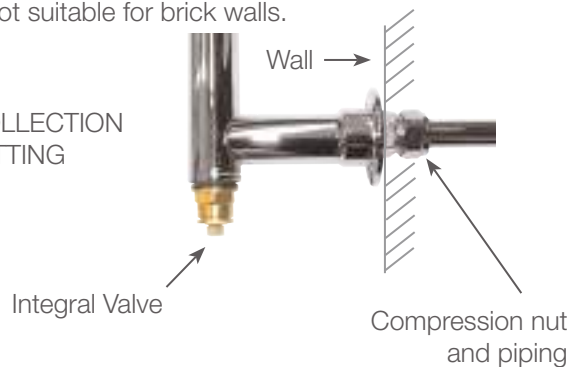

Standard installation with visible valve.



Integral valve is hidden within the towel rail.



Vivid Integral Valve	Dimensions (mm)			Bar config	Pipe centres	Output $\Delta T 50^{\circ}\text{C}$ Watts/BTU's	Output $\Delta T 60^{\circ}\text{C}$ BTU's	Stock or made to order		
	BR	30	H						H	W
IVCN021			400	1200	94	3	1150	183 / 624	791	
IVCN021 single bar			50	400	94	1	325	21 / 72	91	
IVCN021 single bar			50	600	94	1	525	30 / 102	129	

Simple and beautiful, this design manufactured from high quality brass, is perfect at the side of a shower. Prices shown are chrome finished for all heating and hot water systems. Please see pages 150 & 151 for finishes and colour options. Pipe work is hidden in the wall. Supplied with service valves, which must be fitted on installation. Not suitable for brick walls.



Robe or Towel Hook

INTEGRAL COLLECTION VALVE FITTING

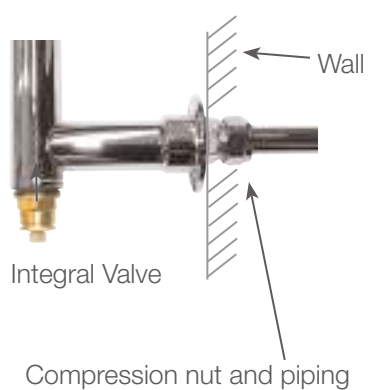

Simplicity Integral Valve		Dimensions (mm)			Bar config	Pipe centres	Output $\Delta T 50^{\circ}\text{C}$ Watts/BTU's	Output $\Delta T 60^{\circ}\text{C}$ BTU's	Stock or made to order
BR	30	H	W	D					
IVCN026		1700	50	115	1	1625	75 / 256	325	

CARINA Wall Mounted MD051



Mild Steel Metallic Finish Supplements
 Gold - POA
 Bright Nickel - Chrome - POA
 Brushed Nickel - Chrome - POA



VL003 **D** **E** \emptyset 22 + 40 x 30mm D Section
 For electric element & valve options see pages 144 & 148

Carina offers curves that work perfectly with the bold tubular design. The towel rail maximises storage space with a top shelf. Finished in chrome to match your sanitaryware. Style and versatility for the most contemporary of settings. Manufactured from high quality mild steel. Prices shown are chrome finished for central heating models.

Carina		Dimensions (mm)			Bar config	Face to Face connections	Electric element wattage	Output $\Delta T50^{\circ}\text{C}$ Watts/BTU's	Output $\Delta T60^{\circ}\text{C}$ BTU's	Stock or made to order	
MS	15	C	H	W							D
	MD051		1200	500	225	8	422	125	223 / 761	965	✓
	MD051		1200	600	225	8	522	150	243 / 829	1051	✓



TR002



TR001

The Solo and Binary are perfect for situations where space is at a premium and style is of priority. This clever design allows you to stack, roll or hang your towels, so they are always warm, dry and handy. Manufactured from quality brass or mild steel and chromed to a mirror finish. Bespoke finishes are available at an additional cost. Please see page 150 for colour options. Prices shown are chrome finished for central heating models.

Mild Steel Metallic Finish Supplements

- Gold - POA
- Bright Nickel - POA
- Brushed Nickel - POA



VL003



For electric element & valve options see pages 144 & 148

Solo and Binary MS 15 C	Dimensions (mm)			Bar config	Pipe Centres	Electric element wattage	Output $\Delta T50^{\circ}C$ Watts/BTU's	Output $\Delta T60^{\circ}C$ BTU's	Stock or made to order
	H	W	D						
TR001-MS	265	500	315	5	425	50	97 / 331	420	✓
TR002-MS	274	500	315	9	425	75	155 / 529	671	✓

Solo and Binary BR 30 H	Dimensions (mm)			Bar config	Pipe Centres	Electric element wattage	Output $\Delta T50^{\circ}C$ Watts/BTU's	Output $\Delta T60^{\circ}C$ BTU's	Stock or made to order
	H	W	D						
TR001	263	500	315	5	425	50	126 / 430	545	✎
TR002	275	500	315	9	425	75	224 / 764	969	✎

COMBY Wall Mounted MD052



Comby is designed to provide completely adaptable towel hanging and storage space. Towels in use can be hung over the cross rails to dry, clean towels placed on the folding shelf. Chromed to a mirror or white painted finish. Prices shown are for central heating models.



VL003



40 x 30 D Section + 22mm

For electric element & valve options see pages 144 & 148

Comby			Dimensions (mm)			Bar config	Pipe centres	Electric element wattage	Output Δ T50°C Watts/BTU's		Output Δ T60°C BTU's		Stock or made to order
MS	15	C	H	W	D				Chrome	White	Chrome	White	
MD052			1200	500	85-110	25	455	300	377 / 1286	507 / 1730	1631	2194	✓
MD052			1200	600	85-110	25	555	300	452 / 1542	683 / 2330	1955	2954	✓

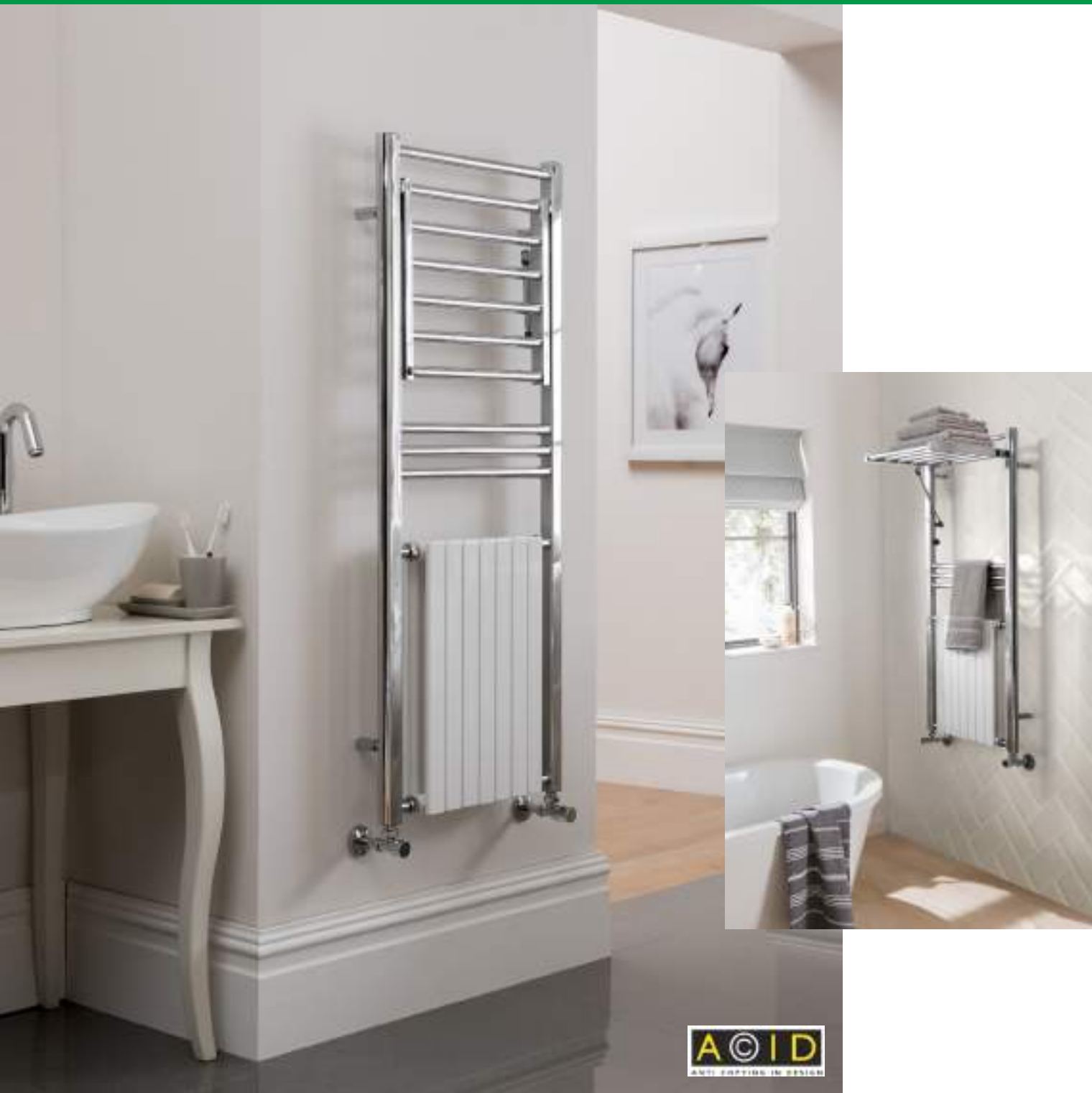

A modern chrome multirail towel warmer with folding shelf combined with a white double panel radiator giving high heat output and drying in a combined unit. Inset radiator available in other radiator RAL colours, Please see page 150 for colour options. Manufactured from mild steel, suitable for closed heating systems and with a 15 year guarantee. Dual fuel and sealed electric element options available.



VL003



40 x 30 D Section + 22mm

For electric element & valve options see pages 144 & 148

Harmonique Duo			Dimensions (mm)			Bar config	Pipe centres	Electric element wattage	Output $\Delta T50^{\circ}\text{C}$ Watts/BTU's	Output $\Delta T60^{\circ}\text{C}$ BTU's	Stock or made to order
MS	15	C	H	W	D						
			1200	500	104	25	455	300	850 / 2900	3677	✓
			1200	600	104	25	555	300	1170 / 3992	5062	✓

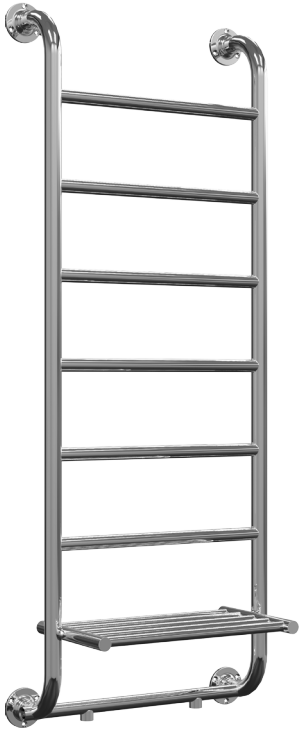

TM014-MS



Please note shelf location may vary when electric model specified

Mild Steel Metallic Finish Supplements

Gold - POA

Bright Nickel - Chrome - POA

Brushed Nickel - Chrome - POA



VL003 valves



32 + 25 + 19mm

25.4 + 22mm

For electric element & valve options see pages 144 & 148

The integrated shelf in this curvaceous design has the added benefit of towel stacking as well as plentiful hanging space. Available in two height options to suit your space with an alternative shelf position which is optional on point of order. Manufactured from high quality brass or mild steel and chrome finished, with bespoke finishes available at an additional cost. Please see pages 150 & 151 for finishes and colour options. Prices shown are chrome finished for central heating models.

Ieri MS			Dimensions (mm)			Bar config	Pipe centres	Electric element wattage	Output $\Delta T50^{\circ}\text{C}$ Watts/BTU's	Output $\Delta T60^{\circ}\text{C}$ BTU's	Stock or made to order
MS	15	C	H	W	D						
			750	525	265	5	240	100	173 / 590	748	✓
			1350	525	265	8	240	200	277 / 945	1198	✓

Ieri			Dimensions (mm)			Bar config	Face to Face connections	Electric element wattage	Output $\Delta T50^{\circ}\text{C}$ Watts/BTU's	Output $\Delta T60^{\circ}\text{C}$ BTU's	Stock or made to order
BR	30	H	H	W	D						
			750	500	265	4	375	100	219 / 747	947	👉
			1350	500	265	7	375	200	329 / 1123	1424	👉

A perfect combination for heating and drying. This versatile product will suit any modern bathroom. With a white double panelled radiator as standard and 25mm chrome horizontal tubes.

Other radiator colours can be specified
Please see page 150 for colour options
Prices shown are for central heating models.

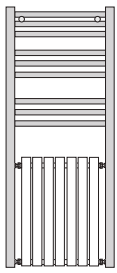

1200 x 500mm
7 Sections

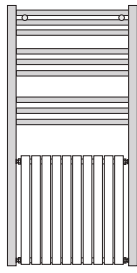

1200 x 600mm
10 Sections

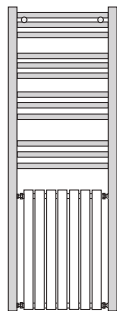

1500 x 500mm
7 Sections

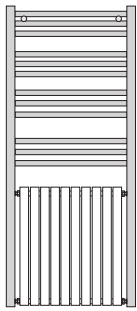

1500 x 600mm
10 Sections



Mild Steel Metallic Finish Supplements

Gold - POA

Bright Nickel - Chrome - POA



VL003



25 + 30 x 40mm D Section

For electric element & valve options see pages 144 & 148



Harmonique		Dimensions (mm)			Bar config	Pipe centres	Electric element wattage	Output $\Delta T50^{\circ}\text{C}$ Watts/BTU's	Output $\Delta T60^{\circ}\text{C}$ BTU's	Stock or made to order	
MS	15	C	H	W							D
			1200	500	107	3-3-3	464	300	834 / 2846	3609	✓
			1200	600	107	3-3-3	564	400	1033 / 3525	4470	✓
			1500	500	107	3-3-3-3	464	400	1145 / 3907	4954	✓
			1500	600	107	3-3-3-3	564	400	1438 / 4906	6221	✓

NEXUS III Wall Mounted TM001



High heat output from a radiator combined with a stylish brass frame makes the perfect combination of heat, good looks and versatility to enhance any bathroom or utility room. Prices shown are for central heating models. The inset radiator comes in white as standard. Please see pages 150 & 151 for finishes and colour options applicable to the tubular frame only. Please Note: The colour option does not apply to the inset radiator.



VL003



25.4 + 15mm

For electric element & valve options see pages 144 & 148

Nexus III BR 30 C	Dimensions (mm)			Bar config	Pipe Centres	Output Δ T50°C Watts/BTU's	Output Δ T60°C BTU's	Electric element wattage	Stock or made to order
	H	W	D						
TM001	900	525	142	6	500	716 / 2443	3098	400	✓



VL003



25.4 + 22mm

For electric element & valve options see pages 144 & 148

The contemporary version of the Nexus Grand (Pages 102 & 103) is manufactured in brass framework and chrome finished. Prices shown are for central heating models. The inset radiator comes in white as standard. Please see pages 150 & 151 for finishes and colour options applicable to the tubular frame only. Please Note: The colour option does not apply to the inset radiator.

Nexus IV			Dimensions (mm)			Bar config	Pipe Centres	Electric element wattage	Output $\Delta T50^{\circ}\text{C}$ Watts/BTU's	Output $\Delta T60^{\circ}\text{C}$ BTU's	Electric element wattage	Stock or made to order
BR	30	C	H	W	D							
TM002	900	590	214	3	500	400	689 / 2351	2981	400	✓		

SESTO RONDO III Wall Mounted MD021



The devil is always in the detail... Sesto Rondo's handsome curves and elegant straight lines are designed to maximise hanging space. Brass manufactured with a chrome finished as standard. Bespoke finishes are available at an additional cost. Please see pages 150 & 151 for finishes and colour options.



VL003



31.8 + 15mm

For electric element & valve options see pages 144 & 148

Features Luxury Air Vent



Sesto Rondo III			Dimensions (mm)			Bar config	Pipe centres	Electric element wattage	Output $\Delta T50^{\circ}\text{C}$ Watts/BTU's	Output $\Delta T60^{\circ}\text{C}$ BTU's	Stock or made to order
BR	30	H	H	W	D						
MD021			820	507	167	21	475	150	339 / 1157	1467	

Something a bit different. A contemporary multirail, with protruding bars for extra towel hanging space. Prices shown are chromed finish for central heating models.



VL003



22mm + 30 x 40 D section

For electric element & valve options see pages 144 & 148

Tempo			Dimensions (mm)			Bar config	Pipe centres	Electric element wattage	Output $\Delta T50^{\circ}\text{C}$ Watts/BTU's	Output $\Delta T60^{\circ}\text{C}$ BTU's	Stock or made to order
MS	15	C	H	W	D						
	MD072		800	500	170-190	19 + 9	455	150	416 / 1419	1799	✓
	MD072		1160	500	170-190	25 + 12	455	300	592 / 2020	2561	✓



be confident

VOGUE

Ladder Rails

The Ladder style towel rail... High heat output and towel hanging space in an efficient format.
Vogue UK have an extensive offering for this benchmark range of products.

Clean designs to suit modern bathrooms...



AXIS 22mm Wall Mounted MD062

Our Axis offers adjustable brackets through the crossbars also offer freedom and ease of installation. Offering a copious amount of rails for optimum efficiency, this contemporary rail is a modern example of proficient design... Prices shown are for chrome finish, central heating models.

New Metallic Finishes



Straight Bars

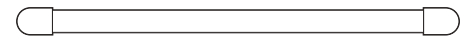

Optional Aroma Plug

Blanking Plug with Aroma Oil Dish

AC035



VL003



22 + 30 x 40mm D Section

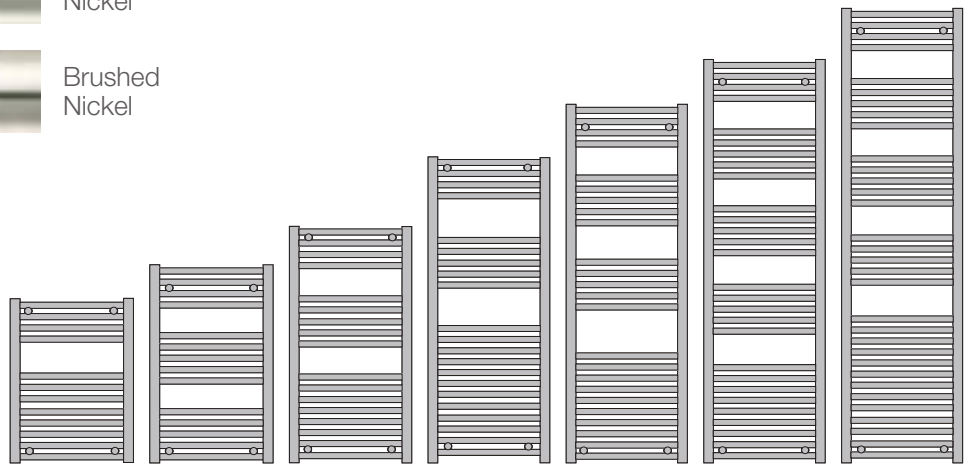

For electric element & valve options see pages 144 & 148

Axis (Straight)	Dimensions (mm)			Bar config	Pipe Centres	Electric element wattage	Output $\Delta T50^{\circ}\text{C}$ Watts/ BTU's	Output $\Delta T60^{\circ}\text{C}$ BTU's	Stock or made to order			
	MS	15	C							H	W	D
MD062				600	400	83 - 105	4-8	355	100	172 / 587	744	✓
MD062				600	500	83 - 105	4-8	455	125	208 / 710	900	✓
MD062				600	600	83 - 105	4-8	555	125	245 / 836	1060	✓
MD062				800	300	83 - 105	4-5-5	255	100	167 / 570	723	✓
MD062				800	400	83 - 105	4-5-5	355	100	209 / 713	904	✓
MD062				800	500	83 - 105	4-5-5	455	125	252 / 860	1090	✓
MD062				800	600	83 - 105	4-5-5	555	150	295 / 1007	1277	✓
MD062				800	750	83 - 105	4-5-5	705	200	359 / 1225	1553	✓
MD062				1000	300	83 - 105	4-5-8	255	150	204 / 696	883	✓
MD062				1000	400	83 - 105	4-5-8	355	150	256 / 873	1107	✓
MD062				1000	500	83 - 105	4-5-8	455	200	308 / 1051	1333	✓
MD062				1000	600	83 - 105	4-5-8	555	200	361 / 1232	1562	✓
MD062				1200	300	83 - 105	4-5-12	255	200	250 / 853	1082	✓
MD062				1200	400	83 - 105	4-5-12	355	200	313 / 1068	1354	✓
MD062				1200	500	83 - 105	4-5-12	455	200	378 / 1290	1636	✓
MD062				1200	600	83 - 105	4-5-12	555	300	443 / 1512	1917	✓
MD062				1200	750	83 - 105	4-5-12	705	300	537 / 1832	2323	✓
MD062				1400	500	83 - 105	4-5-5-10	455	300	431 / 1471	1865	✓
MD062				1400	600	83 - 105	4-5-5-10	555	300	504 / 1720	2181	✓
MD062				1600	400	83 - 105	4-5-5-9	355	300	412 / 1406	1783	✓
MD062				1600	500	83 - 105	4-5-5-9	455	300	495 / 1689	2142	✓
MD062				1600	600	83 - 105	4-5-5-9	555	400	580 / 1979	2509	✓
MD062				1800	400	83 - 105	4-5-5-13	355	400	464 / 1583	2007	✓
MD062				1800	500	83 - 105	4-5-5-13	455	400	558 / 1904	2414	✓
MD062				1800	600	83 - 105	4-5-5-13	555	400	654 / 2231	2829	✓
MD062				1800	750	83 - 105	4-5-5-13	705	400	815 / 2781	3526	✓



COMBES 22mm Wall Mounted MD063

Our Combes offers adjustable brackets through the crossbars also offer freedom and ease of installation. Offering a copious amount of rails for optimum efficiency, this contemporary rail is a modern example of proficient design... The curved version of our MD062. Prices shown are for chromed finish, central heating models.

New Metallic Finishes



Bright Nickel



Brushed Nickel



Optional Aroma Plug

Blanking Plug with Aroma Oil Dish

AC035

Curved Bars



VL003



22 + 30 x 40mm D Section

For electric element & valve options see pages 144 & 148

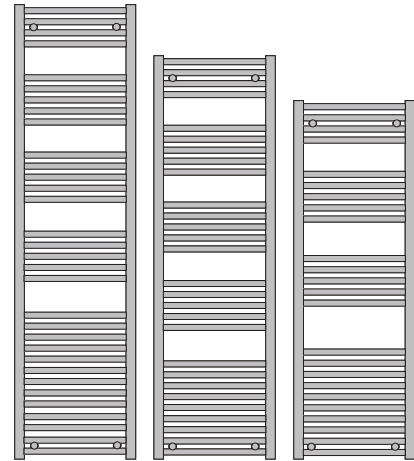

1800mm 32 cross bars
1600mm 28 cross bars
1400mm 24 cross bars

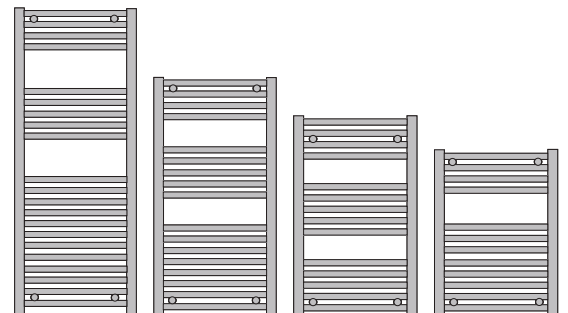

1200mm 21 cross bars
1000mm 17 cross bars
800mm 14 cross bars
600mm 12 cross bars

Combes (Curved)	Dimensions (mm)			Bar config	Pipe Centres	Electric element wattage	Output $\Delta T50^{\circ}\text{C}$ Watts/BTU's	Output $\Delta T60^{\circ}\text{C}$ BTU's	Stock or made to order			
	MS	15	C							H	W	D
MD063				800	500	89 - 119	4-5-5	455	150	252 / 860	1090	✓
MD063				800	600	95 - 125	4-5-5	555	150	295 / 1007	1277	✓
MD063				1000	500	89 - 119	4-5-8	455	200	308 / 1051	1333	✓
MD063				1000	600	95 - 125	4-5-8	555	200	361 / 1232	1562	✓
MD063				1200	500	89 - 119	4-5-12	455	200	378 / 1290	1636	✓
MD063				1200	600	95 - 125	4-5-12	555	300	443 / 1512	1917	✓
MD063				1400	500	89 - 119	4-5-5-10	455	300	431 / 1471	1865	✓
MD063				1400	600	95 - 125	4-5-5-10	555	300	504 / 1720	2181	✓
MD063				1600	500	89 - 119	4-5-5-5-9	455	300	495 / 1689	2142	✓
MD063				1600	600	95 - 125	4-5-5-5-9	555	400	580 / 1979	2509	✓
MD063				1800	500	89 - 119	4-5-5-5-13	455	400	558 / 1904	2414	✓
MD063				1800	600	95 - 125	4-5-5-5-13	555	400	654 / 2231	2829	✓



FOCUS 25mm Wall Mounted MD001



Image shown with VL015 valves

The Focus is a range of 25mm horizontal tube design towel rails. Giving high heat output and superior looks. Manufactured from high quality mild steel with smooth flat tops and rear air vent. Prices shown are for chrome and white central heating models.

Available in other contemporary colours please see page 67 onwards. Please see page 150 for other colour options.

New Metallic Finishes



Bright Nickel



Brushed Nickel



VL003



Straight Bars

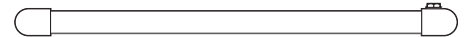

25 + 30 x 40mm D Section

For electric element & valve options see pages 144 & 148

Focus MS 15 C	Dimensions (mm)			Bar config	Electric element wattage	Output $\Delta T50^{\circ}\text{C}$ Watts/BTU's		Output $\Delta T60^{\circ}\text{C}$ BTU's		Stock or made to order
	H	W	D			chrome	white	chrome	white	
MD001	800	300	93-113	3-5-6	100	177 / 604	271 / 925	766	1173	✓
MD001	800	400	93-113	3-5-6	125	226 / 771	346 / 1181	978	1498	✓
MD001	800	500	93-113	3-5-6	150	275 / 938	420 / 1433	1189	1817	✓
MD001	800	600	93-113	3-5-6	200	324 / 1105	495 / 1689	1401	2142	✓
MD001	1000	500	93-113	4-5-9	200	351 / 1198	446 / 1522	1519	1930	✓
MD001	1000	600	93-113	4-5-9	200	414 / 1413	510 / 1742	1792	2209	✓
MD001	1200	300	93-113	4-5-13	200	273 / 931	424 / 1447	1181	1835	✓
MD001	1200	400	93-113	4-5-13	200	350 / 1194	543 / 1853	1514	2350	✓
MD001	1200	500	93-113	4-5-13	300	428 / 1460	663 / 2262	1851	2868	✓
MD001	1200	600	93-113	4-5-13	400	505 / 1723	783 / 2672	2185	3388	✓
MD001	1500	500	93-113	4-5-7-12	300	534 / 1822	820 / 2798	2310	3548	✓
MD001	1500	600	93-113	4-5-7-12	400	631 / 2153	969 / 3306	2730	4192	✓
MD001	1800	400	93-113	4-5-12-13	400	521 / 1778	793 / 2706	2255	3431	✓
MD001	1800	500	93-113	4-5-12-13	600	638 / 2177	969 / 3306	2760	4192	✓
MD001	1800	600	93-113	4-5-12-13	600	754 / 2573	1146 / 3910	3263	4958	✓

The curved version of the Focus. The Chorus has all the same attributes with high heat output and superb looks. Prices shown are for chrome or white central heating models. Please see page 150 for other colour options.



Rear Air Vent

Capped off smooth ends for aesthetic appeal and ease of installation.

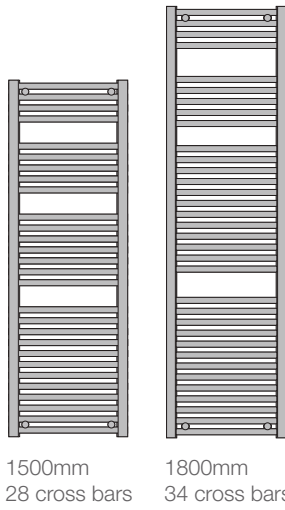

1500mm 28 cross bars
1800mm 34 cross bars

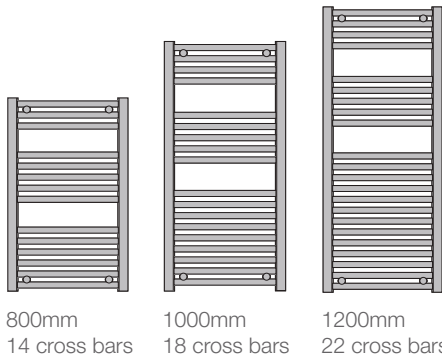

800mm 14 cross bars
1000mm 18 cross bars
1200mm 22 cross bars

Curved Bars



VL003



25 + 30 x 40mm D Section

For electric element & valve options see pages 144 & 148



Image shown with VL015 valves

Chorus MS 15 C	Dimensions (mm)			Bar config	Pipe centres	Electric element wattage	Output $\Delta T50^{\circ}\text{C}$ Watts/BTU's		Output $\Delta T60^{\circ}\text{C}$ BTU's		Stock or made to order
	H	W	D				chrome	white	chrome	white	
MD002	800	500	88-108	3-5-6	455	150	275 / 938	420 / 1433	1189	1817	✓
MD002	800	600	94-114	3-5-6	555	200	324 / 1105	495 / 1689	1401	2142	✓
MD002	1000	500	88-108	4-5-9	455	200	351 / 1198	-	1519	-	✓
MD002	1000	600	94-114	4-5-9	555	200	414 / 1413	-	1792	-	✓
MD002	1200	500	88-108	4-5-13	455	300	428 / 1460	663 / 2262	1851	2868	✓
MD002	1200	600	94-114	4-5-13	555	400	505 / 1723	783 / 2672	2185	3388	✓
MD002	1500	500	88-108	4-5-7-12	455	300	534 / 1822	820 / 2798	2310	3548	✓
MD002	1500	600	94-114	4-5-7-12	555	400	631 / 2153	969 / 3306	2730	4192	✓
MD002	1800	500	88-108	4-5-12-13	455	600	638 / 2177	969 / 3306	2760	4192	✓
MD002	1800	600	94-114	4-5-12-13	555	600	754 / 2573	1146 / 3910	3263	4958	✓

FOCUS HORIZONTAL 25mm Wall Mounted MD001H



New for 2019

The horizontal version of the Focus. Allowing you to hang towels side by side and a perfect fit for underneath a window or shelf, our Focus horizontal is a smart alternative to the typical ladder- rail style. With all the same attributes, high heat output and superb looks. Prices shown are for chrome or Anthracite central heating models. Please see page 150 for other colour options.



VL003



25 + 30 x 40mm D Section

For electric element & valve options see pages 144 & 148

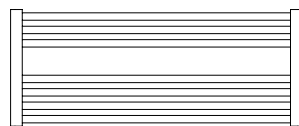

400mm
7 cross bars

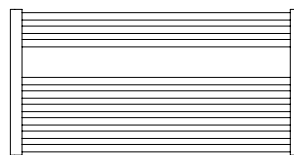

500mm
9 cross bars

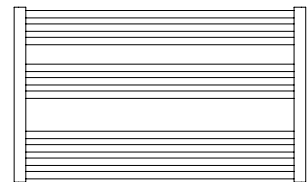

600mm
10 cross bars

Focus Horizontal	Dimensions (mm)			Bar config	Pipe centres	Electric element wattage	Output $\Delta T50^{\circ}\text{C}$ Watts/BTU's		Output $\Delta T60^{\circ}\text{C}$ BTU's		Stock or made to order
	H	W	D				chrome	Anthracite	chrome	Anthracite	
MS 15 C MD001H	400	1000	93-113	3-4	955	100	200 / 682	302 / 1030	865	1306	✓
MD001H	500	1000	93-113	3-6	955	125	256 / 873	386 / 1317	1107	1670	✓
MD001H	600	1000	93-113	3-3-4	955	150	288 / 983	434 / 1481	1246	1878	✓

Contemporary painted finishes in our popular 25mm horizontal tube multirail. Prices shown are for central heating models. Optional accessories available in different finishes.

Contemporary Finishes

-  Latte Textured
-  Cappuccino Textured
-  Mocha Textured
-  Espresso Gloss
-  Anthracite Textured
-  Satin Black
-  Matt Black
-  White Sparkle
-  Grey Sparkle

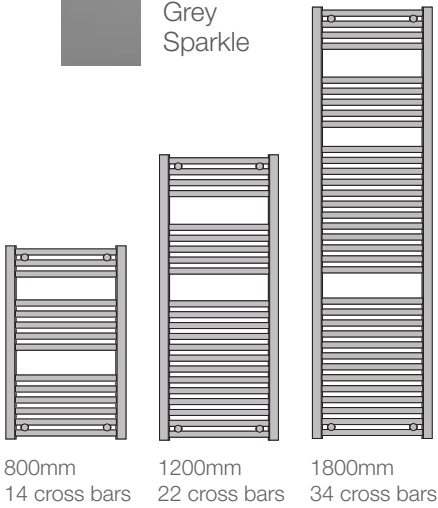

Painted colour options available in our popular Arne (VL003) valves.



VL003 25 + 30 x 40mm D Section
For electric element & valve options see pages 144 & 148



Satin Black Finish

Focus Colours	Dimensions (mm)			Bar config	Pipe centres	Electric element wattage	Output Δ T50°C Watts/ BTU's	Output Δ T60°C BTU's	Stock or made to order
	MS	15	C						
MD001				3-5-6	455	150	420 / 1433	1817	✓
MD001				4-5-13	255	200	424 / 1447	1835	✓
MD001				4-5-13	455	300	663 / 2262	2868	✓
MD001				4-5-13	555	400	783 / 2672	3388	✓
MD001				4-5-12-13	455	600	969 / 3306	4192	✓

FOCUS GREY SPARKLE 25mm Wall Mounted MD001

Stocked in a selection of our most popular sizes, our grey sparkle finish adds a dazzling hue to our staple multirail.

Contemporary Finishes

-  Latte Textured
-  Cappuccino Textured
-  Mocha Textured
-  Espresso Gloss
-  Anthracite Textured
-  Satin Black
-  Matt Black
-  White Sparkle
-  Grey Sparkle

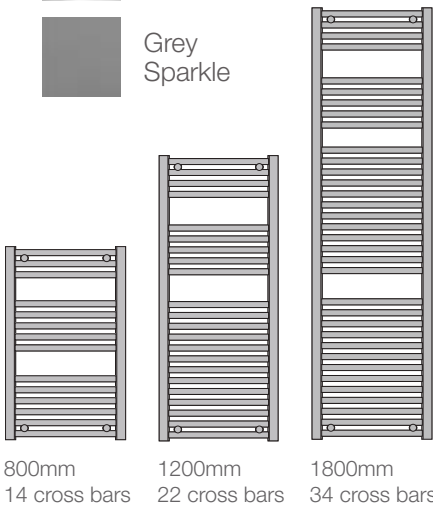

Painted colour options available in our popular Arne (VL003) valves.



VL003 25 + 30 x 40mm D Section
For electric element & valve options see pages 144 & 148



New for 2019

Focus Colours	Dimensions (mm)			Bar config	Pipe centres	Electric element wattage	Output $\Delta T50^{\circ}\text{C}$ Watts/ BTU's	Output $\Delta T60^{\circ}\text{C}$ BTU's	Stock or made to order
	MS	15	C						
MD001				3-5-6	455	150	420 / 1433	1817	✓
MD001				4-5-13	255	200	424 / 1447	1835	✓
MD001				4-5-13	455	300	663 / 2262	2868	✓
MD001				4-5-13	555	400	783 / 2672	3388	✓
MD001				4-5-12-13	455	600	969 / 3306	4192	✓

Explore our best- selling sizes with a subtle glimmer of white sparkle...

Contemporary Finishes

-  Latte Textured
-  Cappuccino Textured
-  Mocha Textured
-  Espresso Gloss
-  Anthracite Textured
-  Satin Black
-  Matt Black
-  White Sparkle
-  Grey Sparkle

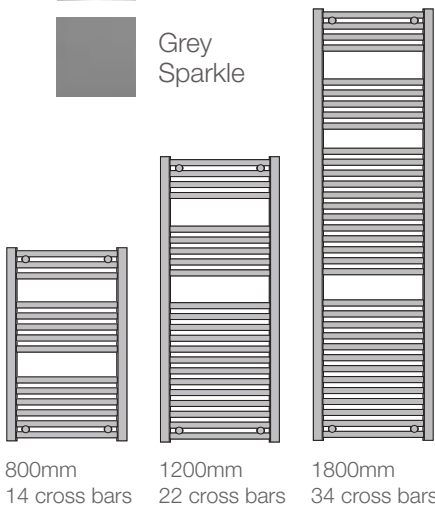

Painted colour options available in our popular Arne (VL003) valves.

VL003  25 + 30 x 40mm D Section

For electric element & valve options see pages 144 & 148



New for 2019

Focus Colours 	Dimensions (mm)			Bar config	Pipe centres	Electric element wattage	Output $\Delta T50^{\circ}\text{C}$ Watts/ BTU's	Output $\Delta T60^{\circ}\text{C}$ BTU's	Stock or made to order
	H	W	D						
MD001	800	500	93 - 113	3-5-6	455	150	420 / 1433	1817	✓
MD001	1200	300	93 - 113	4-5-13	255	200	424 / 1447	1835	✓
MD001	1200	500	93 - 113	4-5-13	455	300	663 / 2262	2868	✓
MD001	1200	600	93 - 113	4-5-13	555	400	783 / 2672	3388	✓
MD001	1800	500	93 - 113	4-5-12-13	455	600	969 / 3306	4192	✓

CHUBE Wall Mounted MD035



The round tube polished stainless steel design with rear air vent, brings together aesthetics and practicality. It will suit any modern bathroom. Please see page 150 for colour options Stainless Steel suitable for all hot water systems.

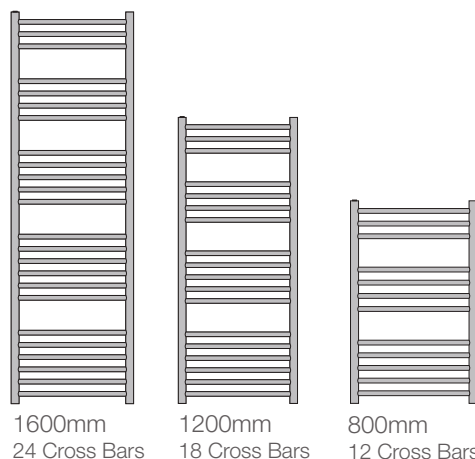

VL003



31.8 + 22mm

For electric element & valve options see pages 144 & 148

Chube (SS) (30) (H)	Dimensions (mm)			Bar config	Pipe centres	Electric element wattage	Output $\Delta T50^{\circ}\text{C}$ Watts/BTU's	Output $\Delta T60^{\circ}\text{C}$ BTU's	Stock or made to order
	H	W	D						
MD035	800	300	100	3-4-5	268	100	161 / 549	696	✓
MD035	800	400	100	3-4-5	368	100	197 / 672	852	✓
MD035	800	500	100	3-4-5	468	125	243 / 829	1051	✓
MD035	800	600	100	3-4-5	568	150	269 / 918	1164	✓
MD035	1200	300	100	3-4-5-6	268	125	240 / 819	1038	✓
MD035	1200	400	100	3-4-5-6	368	150	294 / 1003	1272	✓
MD035	1200	500	100	3-4-5-6	468	200	348 / 1187	1505	✓
MD035	1200	600	100	3-4-5-6	568	200	402 / 1372	1740	✓
MD035	1600	300	100	3-4-5-6-6	268	200	321 / 1095	1388	✓
MD035	1600	400	100	3-4-5-6-6	368	200	391 / 1334	1692	✓
MD035	1600	500	100	3-4-5-6-6	468	300	464 / 1583	2007	✓
MD035	1600	600	100	3-4-5-6-6	568	300	536 / 1829	2319	✓

Kerve is the curvaceous sibling of the Chube. As the name suggests the hanging bars have a gentle tactile bow. The design has an integral rear air vent for aesthetic appeal and ease of installation. Available in a wide range of heights and widths. Polished stainless steel manufacture, suitable for all hot water systems. Please see page 150 for colour options



Curved Bars

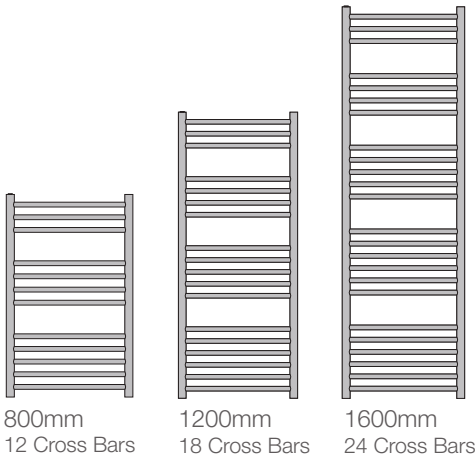

800mm
12 Cross Bars

1200mm
18 Cross Bars

1600mm
24 Cross Bars



VL003



31.8 + 22mm

For electric element & valve options see pages 144 & 148



Kerve	Dimensions (mm)			Bar config	Pipe centres	Electric element wattage	Output $\Delta T50^{\circ}C$ Watts/BTU's	Output $\Delta T60^{\circ}C$ BTU's	Stock or made to order
	H	W	D						
MD036	800	500	120	3-4-5	468	125	243 / 829	1051	✓
MD036	800	600	130	3-4-5	568	150	269 / 918	1164	✓
MD036	1200	500	120	3-4-5-6	468	200	348 / 1187	1505	✓
MD036	1200	600	130	3-4-5-6	568	200	402 / 1372	1740	✓
MD036	1600	500	120	3-4-5-6-6	468	300	464 / 1583	2007	✓
MD036	1600	600	130	3-4-5-6-6	568	300	536 / 1829	2319	✓

GALAXY Wall Mounted MD059

Galaxy has clean lines and plenty of hanging space. Manufactured from polished stainless steel. Please see page 150 for colour options Suitable for all hot water systems.

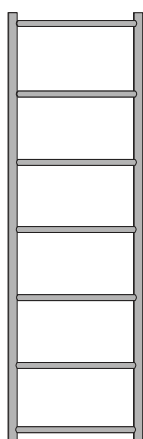

1600mm
7 cross bars

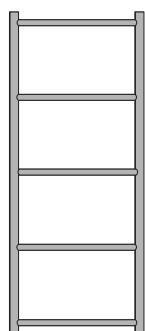

1200mm
5 cross bars

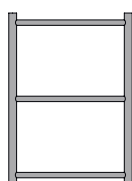

700mm
3 cross bars



VL003



31.8 + 22mm

For electric element & valve options see pages 144 & 148

Galaxy SS 30 H	Dimensions (mm)			Bar config	Pipe Centres	Electric element wattage	Output Δ T50°C Watts/BTU's	Output Δ T60°C BTU's	Stock or made to order
	H	W	D						
MD059	700	500	100	3	468	75	86 / 293	372	✓
MD059	1200	500	100	5	468	100	217 / 740	938	✓
MD059	1600	500	100	7	468	125	296 / 1010	1281	✓



High quality polished stainless steel. Pearl's chic styling and sensible design allows you to hang towels side by side. Suitable for all hot water systems. Please see page 150 for colour options



VL003



31.8 + 22mm

For electric element & valve options see pages 144 & 148



600mm
9 cross bars

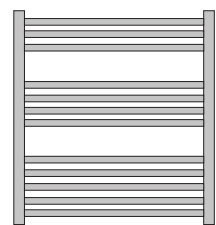

800mm
12 cross bars

Pearl 	Dimensions (mm)			Bar config	Pipe Centres	Output Δ T50°C Watts/BTU's	Output Δ T60°C BTU's	Electric element wattage	Stock or made to order
	H	W	D						
MD058	600	750	100	4-5	718	419 / 1430	1813	100	✓
MD058	600	1000	100	4-5	968	517 / 1764	2237	125	✓
MD058	800	750	100	3-4-5	718	529 / 1805	2289	125	✓
MD058	800	1000	100	3-4-5	968	682 / 2327	2951	150	✓



Contemporary style, these multirails work well with most interior design schemes. Tune has straight cross rails and the Melody has a gentle curve. Both are exceptionally practical and work well in bathrooms and kitchens alike. Prices shown are chrome finished for central heating models.

Optional Aroma Plug



Blanking Plug with Aroma Oil Dish

AC035

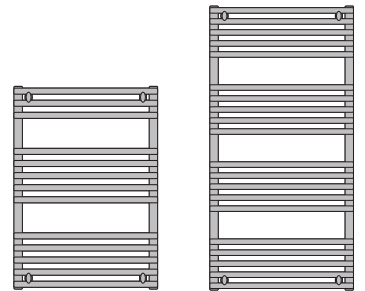

772mm
13 Cross Bars

1186mm
20 Cross Bars

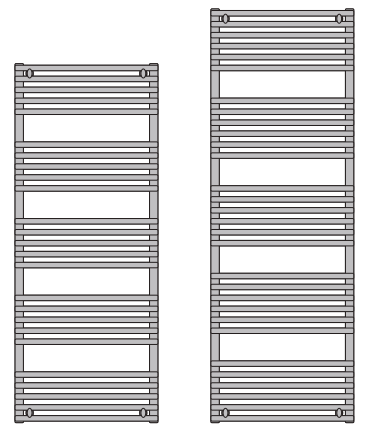

1508mm
25 Cross Bars

1738mm
30 Cross Bars



VL003



32 + 22mm

For electric element & valve options see pages 144 & 148

Tune (Straight)	Dimensions (mm)			Bar config	Pipe centres	Electric element wattage	Output $\Delta T50^{\circ}\text{C}$ Watts/BTU's	Output $\Delta T60^{\circ}\text{C}$ BTU's	Stock or made to order
	MS	15	C						
MD003				3-5-5	450	125	290 / 989	1254	✓
MD003				3-5-5	550	200	347 / 1184	1501	✓
MD003				5-5-5-5	450	300	465 / 1587	2012	✓
MD003				5-5-5-5	550	300	553 / 1887	2393	✓
MD003				5-5-5-5-5	450	400	581 / 1982	2513	✓
MD003				5-5-5-5-5	550	400	686 / 2341	2968	✓
MD003				6-6-6-6-6	450	600	687 / 2344	2972	✓
MD003				6-6-6-6-6	550	600	815 / 2781	3526	✓



Melody (Curved)	Dimensions (mm)			Bar config	Pipe centres	Electric element wattage	Output $\Delta T50^{\circ}\text{C}$ Watts/BTU's	Output $\Delta T60^{\circ}\text{C}$ BTU's	Stock or made to order
	MS	15	C						
MD004				3-5-5	450	125	290 / 989	1254	✓
MD004				3-5-5	550	200	347 / 1184	1501	✓
MD004				5-5-5-5	450	300	465 / 1587	2012	✓
MD004				5-5-5-5	550	300	553 / 1887	2393	✓
MD004				5-5-5-5-5	450	400	581 / 1982	2513	✓
MD004				5-5-5-5-5	550	400	686 / 2341	2968	✓
MD004				6-6-6-6-6	450	600	686 / 2341	2968	✓
MD004				6-6-6-6-6	550	600	815 / 2781	3526	✓

STELLA Wall Mounted MD034



Contemporary styling always makes an impact. Stella is manufactured from polished stainless steel. Please see page 150 for colour options. Suitable for all hot water systems.

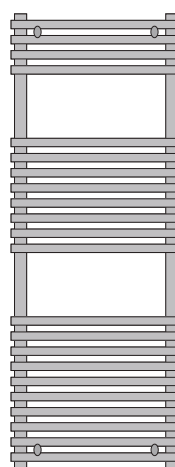

1200mm
22 cross bars

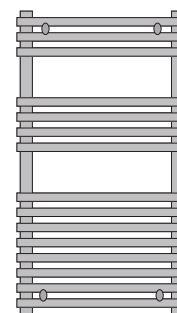

800mm
15 cross bars



VL003



∅ 22 + 30mm

For electric element & valve options see pages 144 & 148

	Stella			Dimensions (mm)			Bar config	Pipe Centres	Electric element wattage	Output $\Delta T50^{\circ}\text{C}$ Watts/BTU's	Output $\Delta T60^{\circ}\text{C}$ BTU's	Stock or made to order
	H	W	D									
	MD034	800	450	75 - 95	3-4-8	400	125	412 / 1406	1783	✓		
	MD034	800	600	75 - 95	3-4-8	550	200	515 / 1757	2228	✓		
	MD034	1200	450	75 - 95	4-8-10	400	200	608 / 2074	2630	✓		
	MD034	1200	600	75 - 95	4-8-10	550	300	759 / 2590	3284	✓		



Simple style, with bold straight cross rails. Manufactured from a high quality brass and chromed to a mirror finish.

Supplied with a hidden rear air vent for aesthetic appeal and ease of installation. Available in three different heights. If you need a different size, talk to us about our bespoke service. Prices shown are for all hot water and heating systems.

Please see pages 150 & 151 for finishes and colour options.



Rear air vent
Capped off smooth ends for aesthetic appeal and ease of installation.

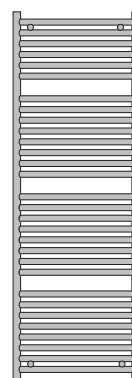

1435mm
30 Cross Bars



1000mm
21 Cross Bars

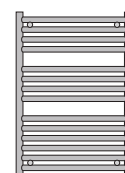

720mm
14 Cross Bars



VL003



31.8 + 25.4mm

For electric element & valve options see pages 144 & 148

Studio BR 30 H	Dimensions (mm)			Bar config	Pipe Centres	Electric element wattage	Output Δ T50°C Watts/BTU's	Output Δ T60°C BTU's	Stock or made to order
	H	W	D						
MD006	720	500	82 - 102	4-4-6	468	125	327 / 1116	1415	✓
MD006	1000	500	82 - 102	6-7-8	468	200	482 / 1645	2086	✓
MD006	1435	500	82 - 102	6-8-8-8	468	300	690 / 2354	2985	✓



be
elegant
elegant

VOGUE

Traditional Towel Rails

A collection of traditional towel rails. Designed and handcrafted by Vogue UK, reflecting our commitment to providing the finest interior pieces.

High quality materials and finishes with our guarantee to stand the test of time.





Mild Steel Metallic Finish Supplements

Gold - POA

Bright Nickel - Chrome - POA



VL008



31.8mm



LG Ball Joint



OG Ball Joint

For electric element & valve options see pages 144 & 148

The classic column radiator towel rail, offering high heat output. Brass or mild steel manufactured framework with an integral white mild steel column radiator. Prices shown are chrome finished for central heating models. Please see pages 150 & 151 for finishes and colour options. Please Note: The colour option does not apply to the Mild Steel (MS) model inset radiators.

Regency MS 15 C	Dimensions (mm)			Bar config	Face to Face connections	Electric element wattage	Output $\Delta T50^{\circ}\text{C}$ Watts/BTU's	Output $\Delta T60^{\circ}\text{C}$ BTU's	Stock or made to order
	H	W	D						
LG004-MS	963	538	230	1	393	200	392 / 1338	1697	✓
LG004-MS	963	673	230	1	528	300	554 / 1890	2397	✓
LG004-MS	963	763	230	1	618	400	653 / 2228	2825	✓

Regency BR 30 C	Dimensions (mm)			Bar config	Face to Face connections	Electric element wattage	Output $\Delta T50^{\circ}\text{C}$ Watts/BTU's	Output $\Delta T60^{\circ}\text{C}$ BTU's	Stock or made to order
	H	W	D						
LG004C-BR	938	500	250	1	343	200	392 / 1338	1697	👤
LG004B-BR	938	675	250	1	518	400	554 / 1890	2397	👤
LG004A-BR	938	735	250	1	578	400	653 / 2228	2825	👤
OG006C-BR	938	500	250	1	343	200	392 / 1338	1697	👤
OG006B-BR	938	675	250	1	518	400	554 / 1890	2397	👤
OG006A-BR	938	735	250	1	578	400	653 / 2228	2825	👤



The Regency II Wall Mounted emanates traditional style. This handmade British design will stand the test of time! A Vogue UK registered design, liked for its heat output, hanging space and unique design. Brass manufactured framework with an integral white mild steel column radiator. Your choice of Legacy or Originals ball joint. Other radiator colours can be specified on ordering. Prices shown are chrome finished for central heating models. Please see pages 150 & 151 for finishes and colour options.



VL008



31.8mm



LG Ball Joint



OG Ball Joint

For electric element & valve options see pages 144 & 148

Regency II BR 30 C	Dimensions (mm)			Bar config	Pipe Centres	Electric element wattage	Output $\Delta T50^{\circ}\text{C}$ Watts/BTU's	Output $\Delta T60^{\circ}\text{C}$ BTU's	Stock or made to order
	H	W	D						
LG036-BR	825	500	150	2	425	200	384 / 1310	1661	
LG036-BR	825	675	150	2	600	400	570 / 1945	2466	
LG036-BR	825	735	150	2	660	400	671 / 2289	2902	
OG009C-BR	825	500	160	2	425	200	384 / 1310	1661	
OG009B-BR	825	675	160	2	600	400	570 / 1945	2466	
OG009A-BR	825	735	160	2	660	400	671 / 2289	2902	

ARCADIA Floor Mounted LG017 / OG017



Arcadia the classic war horse!

A very British design which has stood the test of time. In brass or mild steel manufactured models, with plenty of towel hanging space. Chromed to a mirror finish, other finishes can be specified on ordering. Other finishes are available, please see page 151.



VL008



31.8mm



LG Ball Joint



OG Ball Joint

Mild Steel Metallic Finish Supplements

Gold - POA

Bright Nickel - Chrome -POA

For electric element & valve options see pages 144 & 148

Arcadia	Dimensions (mm)			Bar config	Face to Face connections	Output $\Delta T50^{\circ}\text{C}$ Watts/BTU's	Output $\Delta T60^{\circ}\text{C}$ BTU's	Electric element wattage	Stock or made to order
	MS	15	C						
LG017-MS				7	453	439 / 1498	1899	2 x 75	✓

Arcadia	Dimensions (mm)			Bar config	Face to Face connections	Output $\Delta T50^{\circ}\text{C}$ Watts/BTU's	Output $\Delta T60^{\circ}\text{C}$ BTU's	Electric element wattage	Stock or made to order
	BR	30	H						
LG017-BR				7	443	439 / 1498	1899	2 x 125	👉
OG017-BR				7	443	439 / 1498	1899	2 x 125	👉



A fixture of yesteryear.

The Baroque uses a classical white mild steel column radiator within a handcrafted, chrome plated, brass framework. Superior heat output and towel hanging space are abundant in this imposing feature design. Many designers place the Baroque in the centre of a bathroom, often next to a free standing cast iron bath. Please see pages 150 & 151 for finishes and colour options. Prices shown are chrome finished for central heating models.



VL008



31.8mm



LG Ball Joint



OG Ball Joint

For electric element & valve options see pages 144 & 148

Baroque	Dimensions (mm)			Bar config	Face to Face connections	Output $\Delta T50^{\circ}C$ Watts/BTU's	Output $\Delta T60^{\circ}C$ BTU's	Electric element wattage	Stock or made to order
	BR	30	C						
LG014-BR				7	518	871 / 2972	3768	200 + 300	
OG016-BR				7	518	871 / 2972	3768	200 + 300	



Mild Steel Metallic Finish Supplements

Gold - POA

Bright Nickel - Chrome - POA



VL018



LG Ball Joint



OG Ball Joint

For electric element & valve options see pages 144 & 148

A classic design with a compact height in three different widths. This towel rail looks great situated above the bath, just at the right height for reaching for your luxuriously warm towel! Brass or Mild Steel manufactured framework with an integral white mild steel column radiator. Other colours can be specified. Please see pages 150 & 151 for finishes and colour options. Please Note: The colour option does not apply to the Mild Steel (MS) model inset radiators. Prices shown are chrome finished for central heating models.

Regency	Dimensions (mm)			Bar config	Pipe Centres	Electric element wattage	Output $\Delta T50^{\circ}\text{C}$ Watts/BTU's	Output $\Delta T60^{\circ}\text{C}$ BTU's	Stock or made to order
	MS	15	C						
LG005-MS				1	600	300	568 / 1938	2457	✓
Regency	Dimensions (mm)			Bar config	Pipe Centres	Electric element wattage	Output $\Delta T50^{\circ}\text{C}$ Watts/BTU's	Output $\Delta T60^{\circ}\text{C}$ BTU's	Stock or made to order
	BR	30	C						
LG005C-BR				1	425	200	384 / 1310	1661	👉
LG005B-BR				1	600	400	541 / 1846	2341	👉
LG005A-BR				1	660	400	643 / 2194	2782	👉
OG015-BR				1	425	200	384 / 1310	1661	👉
OG015-BR				1	600	400	541 / 1846	2341	👉
OG015-BR				1	660	400	643 / 2194	2782	👉

Ideal for family bathrooms or a special en-suite. Brass or Mild steel manufactured framework with an integral white mild steel column radiator. Brass versions come with an extra towel bar above the column radiator and are available in optional metallic and colour finishes. Please see pages 150 & 151 for finishes and colour options. Please Note: The colour option does not apply to the Mild Steel (MS) model inset radiators. Prices shown are chrome finished for central heating models.

Mild Steel Metallic Finish Supplements

Gold - POA

Bright Nickel - Chrome - POA

Element position advised at point of ordering.



LG013WM-MS



OG Ball Joint

LG013FW-MS



VL008



31.8mm



LG Ball Joint

For electric element & valve options see pages 144 & 148



Regency Tall WM MS 15 C	Dimensions (mm)			Bar config	Pipe Centres	Electric element wattage	Output $\Delta T50^{\circ}\text{C}$ Watts/BTU's	Output $\Delta T60^{\circ}\text{C}$ BTU's	Stock or made to order
	H	W	D						
LG013WM-MS	1403	575	250	2	500	400	824 / 2811	3564	✓
Regency Tall MS 15 C	Dimensions (mm)			Bar config	Face to Face connections	Electric element wattage	Output $\Delta T50^{\circ}\text{C}$ Watts/BTU's	Output $\Delta T60^{\circ}\text{C}$ BTU's	Stock or made to order
	H	W	D						
LG013FW-MS	1500	500	250	2	355	400	815 / 2781	3526	✓
Regency Tall BR 30 C	Dimensions (mm)			Bar config	Face to Face connections	Electric element wattage	Output $\Delta T50^{\circ}\text{C}$ Watts/BTU's	Output $\Delta T60^{\circ}\text{C}$ BTU's	Stock or made to order
	H	W	D						
LG013FW-BR	1500	500	250	3	343	400	738 / 2518	3193	✎
OG007FW-BR	1500	500	250	3	343	400	738 / 2518	3193	✎

BALLERINA Floor and Wall Mounted LG024A-MS / LG021-MS



This Ballerina wall and floor mounted towel rail is offered in a Legacy ball joint mild steel version as detailed on this page. Prices shown are chrome finished central heating models. The high quality brass versions (opposite) are available with Legacy or Originals Balljoint. The LG021-MS comes with added balljoints on the inlet connections to compliment the style further.



VL008



For electric element & valve options see pages 144 & 148



LG Ball Joint

Mild Steel Metallic Finish Supplements

Gold - POA

Bright Nickel - Chrome - POA

Ballerina MS 15 C	Dimensions (mm)			Bar config	Face to Face connections	Electric element wattage	Output $\Delta T50^{\circ}\text{C}$ Watts/BTU's	Output $\Delta T60^{\circ}\text{C}$ BTU's	Stock or made to order
	H	W	D						
LG024A-MS	848	598	138	4	454	100	163 / 556	705	✓
LG021-MS	1549	598	138	5	454	150	310 / 1058	1342	✓



High quality brass, supremely durable for longevity. The Ballerina wall and floor is available with your choice of Legacy or Originals ball joint. Prices shown are chrome finished for all heating and hot water systems. Other finishes are available, please see page 151.

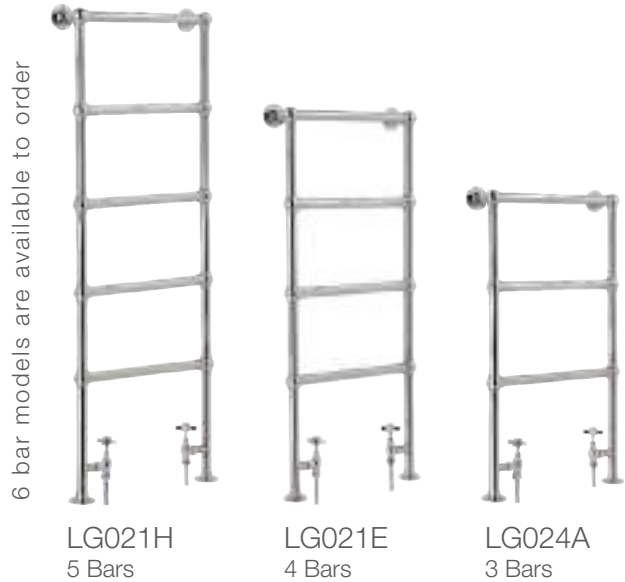

For electric element & valve options see pages 144 & 148

Ballerina BR 30 H	Dimensions (mm)			Bar config	Face to Face connections	Electric element wattage	Output $\Delta T50^{\circ}C$ Watts/BTU's	Output $\Delta T60^{\circ}C$ BTU's	Stock or made to order
	H	W	D						
LG024C-BR	938	575	138	3	418	100	163 / 556	705	👉
LG024A-BR	938	675	138	3	518	125	195 / 665	843	👉
LG024B-BR	938	825	138	3	668	150	207 / 706	895	👉
LG021A-BR	1238	525	138	4	368	125	239 / 815	1033	👉
LG021E-BR	1238	675	138	4	518	150	266 / 908	1151	👉
LG021D-BR	1538	525	138	5	368	150	292 / 996	1263	👉
LG021H-BR	1538	675	138	5	518	150	327 / 1116	1415	👉
OG003A-BR	938	575	138	3	418	100	163 / 556	705	👉
OG003B-BR	938	675	138	3	518	125	195 / 665	843	👉
OG003C-BR	938	825	138	3	668	150	207 / 706	895	👉
OG003D-BR	1238	525	138	4	368	125	239 / 815	1033	👉
OG003E-BR	1238	675	138	4	518	150	266 / 908	1151	👉
OG003F-BR	1538	525	138	5	368	125	292 / 996	1263	👉
OG003G-BR	1538	675	138	5	518	150	327 / 1116	1415	👉

BALLERINA Wall Mounted LG010A-MS



The Ballerina wall mounted towel rail is offered in a Legacy ball joint mild steel version, as detailed on this page. Prices shown are chrome finished central heating models.

The high quality brass versions (opposite) are available with Legacy or Originals Balljoint.

Mild Steel Metallic Finish Supplements

Gold - POA

Bright Nickel - Chrome - POA



VL008



31.8mm

LG Ball Joint



For electric element & valve options see pages 144 & 148

Ballerina		Dimensions (mm)			Bar config	Pipe Centres	Electric element wattage	Output $\Delta T50^{\circ}\text{C}$ Watts/BTU's	Output $\Delta T60^{\circ}\text{C}$ BTU's	Stock or made to order
MS	15	C	H	W						
LG010A-MS	748	498	124	4	424	100	169 / 577	732	✓	



High quality brass, durable for longevity, the Ballerina is available with your choice of Legacy (as pictured) or Originals ball joint. Prices shown are chrome finished for all heating and hot water systems. Other finishes are available, please see page 151.

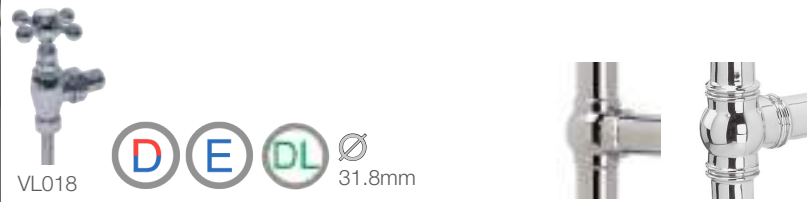

For electric element & valve options see pages 144 & 148 LG Ball Joint OG Ball Joint

Ballerina BR 30 H	Dimensions (mm)			Bar config	Pipe Centres	Electric element wattage	Output $\Delta T50^{\circ}C$ Watts/BTU's	Output $\Delta T60^{\circ}C$ BTU's	Stock or made to order
	H	W	D						
LG025A-BR	675	675	125	3	600	100	167 / 570	723	Hand icon
LG025B-BR	675	825	125	3	750	125	190 / 648	822	Hand icon
LG010A-BR	750	500	125	4	425	100	169 / 577	732	Hand icon
LG021B-BR	1275	525	125	4	450	125	239 / 815	1033	Hand icon
LG021F-BR	1275	675	125	4	600	150	266 / 908	1151	Hand icon
LG021C-BR	1575	525	125	5	450	125	292 / 996	1263	Hand icon
LG021G-BR	1575	675	125	5	600	150	327 / 1116	1415	Hand icon
OG002B-BR	675	675	135	3	600	100	167 / 570	723	Hand icon
OG002C-BR	675	825	135	3	750	125	190 / 648	822	Hand icon
OG002D-BR	750	525	135	4	450	100	169 / 577	732	Hand icon
OG002A-BR	1275	525	135	4	450	125	239 / 815	1033	Hand icon
OG002E-BR	1275	675	135	4	600	150	266 / 908	1151	Hand icon
OG002F-BR	1575	525	135	5	450	125	292 / 996	1263	Hand icon
OG002G-BR	1575	675	135	5	600	150	327 / 1116	1415	Hand icon

GRANDEUR Floor and Wall Mounted LG032FW



Reflecting the quality and craftsmanship of a bygone age. Manufactured from our most robust 38mm diameter brass tube, this towel rail is of a timeless nature and would sit well in any traditional setting. Available in two heights to suit your requirements.

Brass manufactured with a chrome finish as standard. Bespoke finishes are available at an additional cost. Other finishes are available, please see page 151.

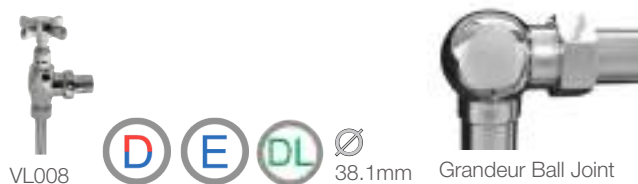

For electric element & valve options see pages 144 & 148

Grandeur BR 30 H	Dimensions (mm)			Bar config	Face to Face connections	Electric element wattage	Output $\Delta T50^{\circ}\text{C}$ Watts/BTU's	Output $\Delta T60^{\circ}\text{C}$ BTU's	Stock or made to order
	H	W	D						
LG032FW	943	686	163	3	522	125	243 / 829	1051	👉
LG032FW	1243	686	163	4	522	200	319 / 1088	1380	👉



The wall mounted Grandeur is available in two different heights and widths, providing ample warm towel hanging space. With classic looks and robust traditional quality, this towel rail is made to outlive fashion!

Brass manufactured with a chrome finish as standard. Bespoke finishes are available at an additional cost. Other finishes are available, please see page 151.



VL008



38.1mm



Grandeur Ball Joint

For electric element & valve options see pages 144 & 148

Grandeur BR 30 H	Dimensions (mm)			Bar config	Pipe Centres	Electric element wattage	Output Δ T50°C Watts/BTU's	Output Δ T60°C BTU's	Stock or made to order
	H	W	D						
LG032WM	686	686	154	3	600	100	220 / 751	952	👉
LG032WM	1286	636	154	4	550	150	321 / 1095	1388	👉

BUTLER Floor and Wall Mounted LG035 / OG004



VL008



For electric element & valve options see pages 144 & 148



LG Ball Joint



OG Ball Joint

This traditional design is tactile and sturdy, a centrepiece for a classically designed bathroom. Brass manufactured, shown with the Originals ball joint. Chrome finish as standard. Bespoke finishes are available at an additional cost. Other finishes are available, please see page 151.

Butler			Dimensions (mm)			Bar config	Face to Face connections	Output $\Delta T50^{\circ}\text{C}$ Watts/BTU's	Output $\Delta T60^{\circ}\text{C}$ BTU's	Electric element wattage	Stock or made to order
BR	30	H	H	W	D						
			940	75	488	4	268	156 / 532	675	100	
			965	75	488	4	268	156 / 532	675	100	

Small is always beautiful. The Hamlet is perfect for en suites and downstairs WCs where space is at a premium, but warm dry towels are still welcomed...

Brass manufactured with a chrome finish as standard with the Originals ball joint. Bespoke finishes are available at an additional cost. Other finishes are available, please see page 151.



LG Ball Joint



OG Ball Joint



VL018



For electric element & valve options see pages 144 & 148

Hamlet			Dimensions (mm)			Bar config	Pipe Centres	Electric element wattage	Output $\Delta T50^{\circ}C$ Watts/BTU's	Output $\Delta T60^{\circ}C$ BTU's	Stock or made to order
BR	30	H	H	W	D						
			235	575	125	2	500	50	79 / 270	342	👉
			235	575	135	2	500	50	79 / 270	342	👉

ELIZABETH Floor and Wall Mounted LG003 / OG019



With sculptured lines and quality ball joints the Elizabeth has a twist on tradition. Brass or Mild Steel manufactured models Chrome finished as standard. Bespoke finishes are available at an additional cost. Other finishes are available, please see page 151.



VL008



31.8 + 25 + 19mm

31.8 + 25.4mm



LG Ball Joint



OG Ball Joint

Mild Steel Metallic Finish Supplements

Gold - POA

Bright Nickel - Chrome - POA

For electric element & valve options see pages 144 & 148

Elizabeth	Dimensions (mm)			Bar config	Face to Face connections	Electric element wattage	Output Δ T50°C Watts/ BTU's	Output Δ T60°C BTU's	Stock or made to order
	MS	15	C						
LG003-MS	963	673	168	8	528	125	290 / 989	1254	✓
Elizabeth	Dimensions (mm)			Bar config	Face to Face connections	Electric element wattage	Output Δ T50°C Watts/ BTU's	Output Δ T60°C BTU's	Stock or made to order
BR	30	H	H						
LG003A	938	675	138	7	518	150	290 / 989	1254	👉
LG003B	938	825	138	7	668	150	372 / 1269	1609	👉
OG019A	938	675	138	7	518	150	290 / 989	1254	👉
OG019B	938	825	138	7	668	150	372 / 1269	1609	👉

The wall mounted Elizabeth is available in two widths with your choice of Legacy (as this page) or Originals ball joints. Chrome finished as standard. Bespoke finishes are available at an additional cost. Other finishes are available, please see page 151.



LG Ball Joint



OG Ball Joint



VL008



31.8 + 25.4mm

For electric element & valve options see pages 144 & 148

Elizabeth BR 30 H	Dimensions (mm)			Bar config	Pipe Centres	Electric element wattage	Output Δ T50°C Watts/BTU's	Output Δ T60°C BTU's	Stock or made to order
	H	W	D						
LG003D	740	675	125	7	600	125	290 / 989	1254	Hand icon
LG003E	740	825	125	7	750	150	372 / 1269	1609	Hand icon
OG019D	740	675	135	7	600	125	290 / 989	1254	Hand icon
OG019E	740	825	135	7	750	150	372 / 1269	1609	Hand icon

ART MODERNE Floor and Wall Mounted OG011



Deco decadence in a nutshell....

High quality hexagonal brass tube manufacture, crafted to a gleaming finish. Available in two sizes and chrome finish as standard. Bespoke finishes are available at an additional cost. Other finishes are available, please see page 151.



VL008



32 HEX mm



Art Moderne
Corner Joint

For electric element & valve options see pages 144 & 148

Art Moderne BR 30 H	Dimensions (mm)			Bar config	Face to Face connections	Electric element wattage	Output Δ T50°C Watts/BTU's	Output Δ T60°C BTU's	Stock or made to order
	H	W	D						
OG011B	943	600	175	3	268	100	197 / 672	852	
OG011A	1543	550	168	5	378	125	318 / 1085	1376	

Perfect for any bathroom with Deco sanitary and brassware, this ever popular style never fades.

The wall mounted Art Moderne is available in three different sizes to suit your room. Brass manufactured with a chrome finish as standard. Bespoke finishes are available at an additional cost. Other finishes are available, please see page 151.

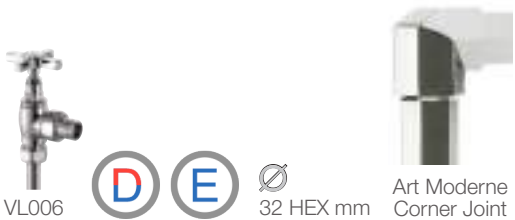

VL006



∅ 32 HEX mm

Art Moderne Corner Joint

For electric element & valve options see pages 144 & 148

Art Moderne BR 30 H	Dimensions (mm)			Bar config	Pipe Centres	Electric element wattage	Output $\Delta T50^{\circ}\text{C}$ Watts/BTU's	Output $\Delta T60^{\circ}\text{C}$ BTU's	Stock or made to order
	H	W	D						
OG010A	836	550	145	4	450	100	211 / 720	913	
OG010B	836	700	145	4	600	125	247 / 843	1069	
OG010C	986	700	145	4	600	125	263 / 897	1137	

ART MODERNE II Wall Mounted OG021



Quality hexagonal brass tube meets a practical brass multirail for an elegant look. Chrome finished as standard. Bespoke finishes are available at an additional cost. Other finishes are available, please see page 151.



VL008



32 HEX + 25.4mm

For electric element & valve options see pages 144 & 148

Unique Art Moderne joint with hexagonal upright and round horizontals



Art Moderne II BR 30 H	Dimensions (mm)			Bar config	Pipe centres	Electric element wattage	Output Δ T50°C Watts/BTU's	Output Δ T60°C BTU's	Stock or made to order
	H	W	D						
OG021	700	532	83 - 106	7-7	500	125	354 / 1208	1532	
OG021	1000	482	83 - 106	6-6-6	450	150	429 / 1464	1856	
OG021	1200	482	83 - 106	5-5-5-5	450	200	487 / 1662	2107	

This characterful robustly British towel warmer hails quality and craftsmanship.

Made for you with your choice of the Legacy or Originals ball joint (pictured).

Brass manufactured with a chrome finish as standard. Bespoke finishes are available at an additional cost. Other finishes are available, please see page 151.



LG Ball Joint OG Ball Joint



VL018



∅ 31.8 + 25.4mm

For electric element & valve options see pages 144 & 148

Penthouse	Dimensions (mm)			Bar config	Pipe centres	Electric element wattage	Output $\Delta T50^{\circ}\text{C}$ Watts/BTU's	Output $\Delta T60^{\circ}\text{C}$ BTU's	Stock or made to order
	BR	30	H						
LG018			1100	20	500	200	532 / 1815	2301	👉
OG020			1100	18	500	200	493 / 1682	2133	👉

COLONNADE 4 Wall Mounted LG023



The distinguished design features both rope and reed tubing providing a stand-out product. Manufactured from high quality brass with a chrome finish as standard. Bespoke finishes are available at an additional cost.

Finish Ideas - See Finishes page 151 for full options



Antique Gold



Melange



Bright Nickel



The Vogue Rose Gold

Featuring both rope and reed tubing



Rope



Reed



VL008



25.4mm

For electric element & valve options see pages 144 & 148

Colonnade 4 BR 30 H	Dimensions (mm)			Bar config	Pipe centres	Electric element wattage	Output Δ T50°C Watts/BTU's	Output Δ T60°C BTU's	Stock or made to order
	H	W	D						
LG023A	775	475	125	4	400	100	169 / 577	732	
LG023B	775	575	125	4	500	100	190 / 648	822	

NEXUS GRAND III Wall Mounted TM003



When combinations are right, something good happens!
 This towel rail has a great heat output from a twin column radiator inset. It is skillfully combined in a brass framework and chrome plated. The two column radiator inset comes in white as standard, other colours can be specified at an additional cost. Please see pages 150 & 151 for finishes and colour options. Prices shown are chrome finished for central heating models.



VL008



25.4 + 15mm

For electric element & valve options see pages 144 & 148

Nexus III			Dimensions (mm)			Bar config	Pipe centres	Electric element wattage	Output $\Delta T50^{\circ}\text{C}$ Watts/BTU's	Output $\Delta T60^{\circ}\text{C}$ BTU's	Stock or made to order
BR	30	C	H	W	D						
TM003	900	525	142 - 160	6	500	400	726 / 2477	3141			

This single curved bar version is a more modern take on the traditional. With the same great heat output and high quality manufacture.

The mild steel two column radiator inset comes in white as standard, other colours can be specified at an additional cost. Quality brass manufactured framework. Please see pages 150 & 151 for finishes and colour options.

Prices shown are chrome finished for central heating models.



VL008



For electric element & valve options see pages 144 & 148

Nexus IV			Dimensions (mm)			Bar config	Pipe centres	Electric element wattage	Output $\Delta T50^{\circ}\text{C}$ Watts/BTU's	Output $\Delta T60^{\circ}\text{C}$ BTU's	Stock or made to order
BR	30	C	H	W	D						
TM004	900	590	214 - 232	3	500	400	699 / 2385	3024			

SEQUEL V Wall Mounted TM006



The Sequel V has Legacy ball joints and emits a fine traditional sense of style. With brass manufactured framework and a white three column mild steel integral radiator it produces a high heat output. Other radiator colours can be specified.

Prices shown are chrome finished for central heating models. Please see pages 150 & 151 for finishes and colour options.



VL018



25.4mm



For electric element & valve options see pages 144 & 148 LG Ball Joint

Sequel V		Dimensions (mm)			Bar config	Pipe centres	Electric element wattage	Output $\Delta T50^{\circ}\text{C}$ Watts/BTU's	Output $\Delta T60^{\circ}\text{C}$ BTU's	Stock or made to order
BR	30	C	H	W						
TM006	1000	525	191-209	4	475	400	716 / 2443	3098		



The Sequel III is manufactured from high quality brass and chrome plated. Curved hanging bars give a modern edge to this traditional style. The three column mild steel radiator inset comes in white as standard, other colours can be specified at an additional cost. Please see pages 150 & 151 for finishes and colour options. Prices shown are chrome finished for central heating models.



VL006



25.4 + 15mm

For electric element & valve options see pages 144 & 148

Sequel III			Dimensions (mm)			Bar config	Pipe centres	Electric element wattage	Output Δ T50°C Watts/BTU's	Output Δ T60°C BTU's	Stock or made to order
BR	30	C	H	W	D						
TM005	1000	550	182-200	8	475	400	741 / 2528	3206			

BASIN STANDS Floor and Wall Mounted





Kensington BSS004
As pictured with nickel finish (left)



Mayfair BSS003
To suit rounded basins



Chelsea BSS006
Pictured heated and wall mounted



City BSS007
Wall mounted with Art Linea joints

Heated or Unheated Basin Stands

Vogue have developed a range of handcrafted brass basin stands produced to order. The styles illustrated can be altered to suit your exact requirements with your choice of metal finish. Other finishes are available, please see page 151.

Please contact us for further information and a specific quotation.



Richmond BSS001

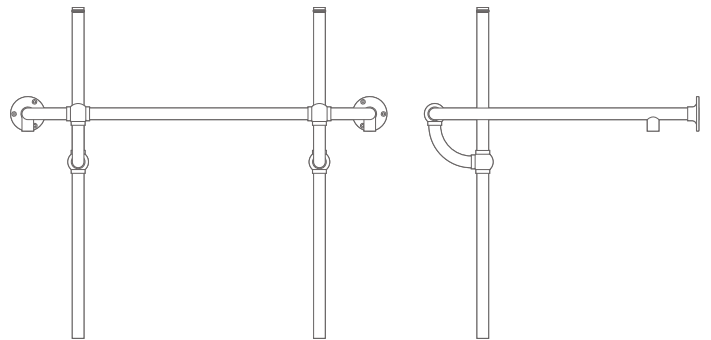

Linea Richmond BSS002

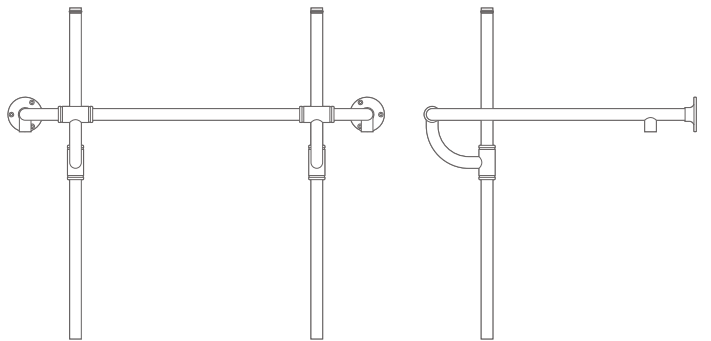

Belgravia BSS005

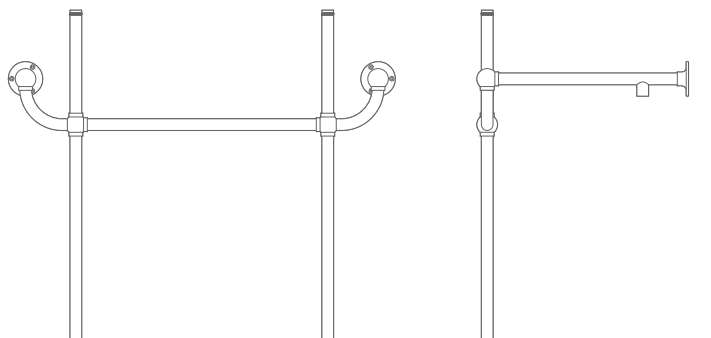

SHOWER CURTAIN RAILS Wall Mounted

Complement Your Bathroom...

Our handmade range of shower curtain rails are beautifully engineered from high quality brass tubing for longevity. As standard they are finished in chrome. Please talk to us if you require other metal finishes or non standard sizes. Other finishes are available, please see page 151.

Oval Ceiling Mounted SCR 1
25.4mm Ø



Single Ended Oval Wall and Ceiling Mounted SCR 2
25.4mm Ø

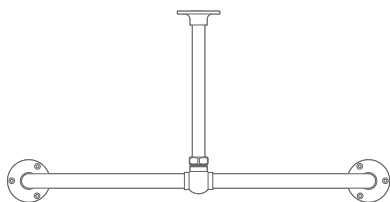
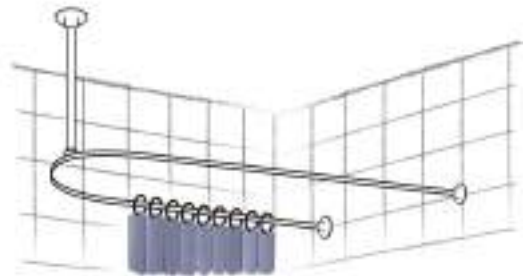
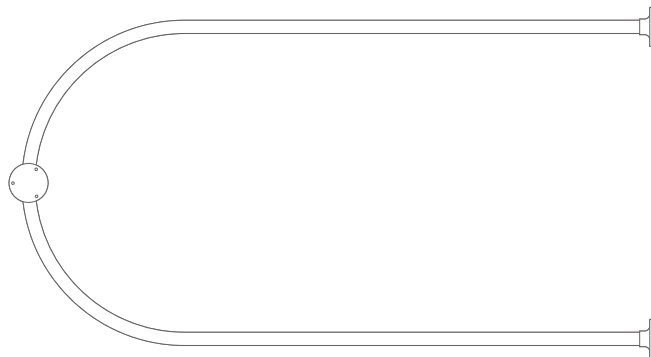

Straight Wall Mounted SCR 3
31.8mm Ø

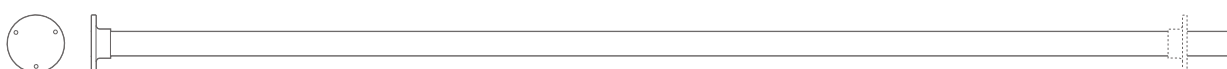

Curved Corner Wall Mounted SCR 4
25.4mm Ø

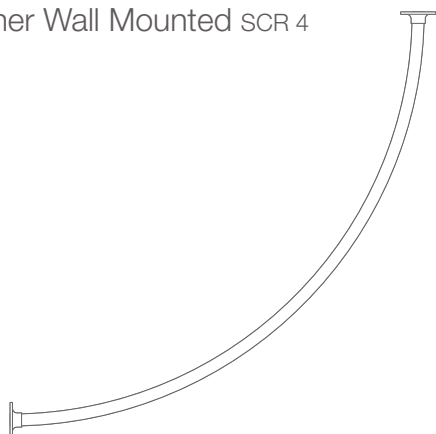

Circular Ceiling Mounted SCR 5
25.4mm Ø



Right Angle Wall Mounted SCR 6
25.4mm Ø

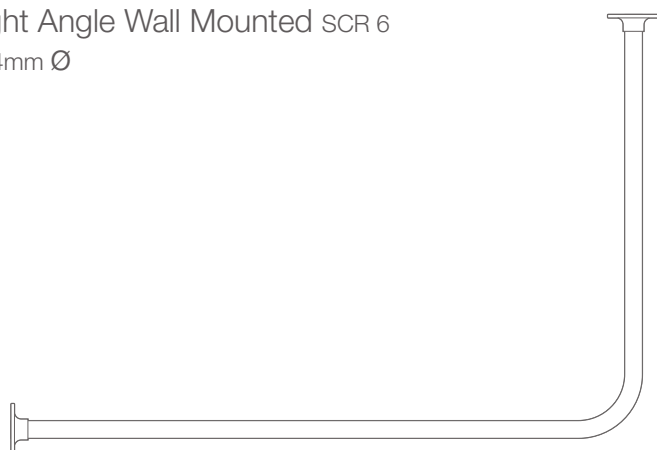

Shower Curtain Rail BR 30	Dimensions (mm)			Description	Stock or made to order
	H	W	D		
SCR 1.1	325	1275	625	Oval shape mounted to ceiling	👉
SCR 1.2	325	1625	625	Oval shape mounted to ceiling	👉
SCR 2.1	338	1238	675	Single ended oval shape mounted to wall and ceiling	👉
SCR 2.2	338	1538	675	Single ended oval shape mounted to wall and ceiling	👉
SCR 3.1	75	1700	75	Straight wall mounted bar	👉
SCR 3.2	75	2000	75	Straight wall mounted bar	👉
SCR 4.1	75	938	938	Round curve for corner applications	👉
SCR 4.2	75	1238	1238	Round curve for corner applications	👉
SCR 5.1	75	775dia	827	Circular wall mounted	👉
SCR 5.2	75	925dia	977	Circular wall mounted	👉
SCR 6.1	75	938	638	Right angled curve for corner applications	👉
SCR 6.2	75	1238	638	Right angled curve for corner applications	👉
SCR 6.3	75	1538	638	Right angled curve for corner applications	👉



be
unique

VOGUE Designer Radiators

Our radiators add warmth and style to any interior scheme.
Radiators can be so much more than white panels on a wall.

Vogue UK designer radiators are a mix of classical and contemporary designs.
They come with our pedigree and quality guarantee.





A contemporary radiator with cylindrical uprights available in white.

Manufactured from mild steel, suitable for closed heating systems and with a 15 year guarantee.



Optional Accessory

Towel Bar - Chrome or White

AC041 (375mm wide)



VL003

For other valve options see page 148

Kate		Dimensions (mm)			End to End connections	Output $\Delta T50^{\circ}\text{C}$ Watts/BTU's	Output $\Delta T60^{\circ}\text{C}$ BTU's	Stock or made to order
MS	15	C	H	W	D			
DR019	1800	370	92-99	370	700 / 2388	3028	✓	



The Suave has a strong, minimalist design, ideal for more contemporary properties. Manufactured in high quality mild steel and finished in anthracite or white. Please see pages 150 for colour options. Magnetic towel bar is an optional extra, please see page 147.



VL003



For electric element & valve options see pages 144 & 148



Anthracite Textured finish option

Suave			Dimensions (mm)			Pipe centres	Electric element wattage	Output $\Delta T50^{\circ}C$ Watts/BTU's	Output $\Delta T60^{\circ}C$ BTU's	Stock or made to order
MS	15	C	H	W	D					
MD056	1800	500	85-100	450	600	669 / 2283	2895	✓		

VISION Wall Mounted DR022

A full length mirror built into a stylish tubular radiator makes Vision an asset in every room in your home. Manufactured from high quality mild steel and available in a Chrome, White or Anthracite finish to blend with any décor.



VL003 \varnothing 32 + 25mm

For other valve options see page 148

Vision			Dimensions (mm)			End to End connections	Output $\Delta T50^{\circ}\text{C}$ Watts/BTU's		Output $\Delta T60^{\circ}\text{C}$ BTU's		Stock or made to order
MS	15	C	H	W	D		Chrome	A & W	Chrome	A & W	
DR022	1800	600	104	600	473 / 1614	713 / 2433	2047	3085	✓		

A bold and clean lined tubular radiator. The Ordinate will integrate well into any room of the house. The radiator is chrome finished and available in four heights, the picture illustrates the tallest model. There are towel rails and robe hooks available to give the Ordinate supreme function for bathrooms and kitchens.

Optional Accessories



Towel Bar - Chrome

AC023A (220mm wide)

AC023B (310mm wide)

AC023C (450mm wide)

Frosted Robe Hook

AC031



VL003 \varnothing 22 + 32mm

For other valve options see page 148



MS	15	C	Ordinate			Dimensions (mm)			Number of tubes	End to End connections	Output $\Delta T50^{\circ}\text{C}$ Watts/BTU's	Output $\Delta T60^{\circ}\text{C}$ BTU's	Stock or made to order
			H	W	D	H	W	D					
			MD005	1000	362	115	8	362	229 / 781	990	✓		
			MD005	1000	452	115	10	454	287 / 979	1241	✓		
			MD005	1200	362	115	8	362	269 / 918	1164	✓		
			MD005	1200	452	115	10	454	337 / 1150	1458	✓		
			MD005	1600	362	115	8	362	350 / 1194	1514	✓		
			MD005	1600	452	115	10	454	437 / 1491	1891	✓		
			MD005	1800	362	115	8	362	390 / 1331	1688	✓		
			MD005	1800	452	115	10	454	487 / 1662	2107	✓		

SQUIRE VERTICAL Wall Mounted DR005



An elegant square tube design with a contemporary feel. However it would also work well in a more traditional interior scheme.

Chromed to a mirror finish with a great heat output. The Squire is available in four different widths.



VL014 25sq + 30sq mm

For other valve options see page 148

Squire Vertical MS 15 C	Dimensions (mm)			Number of tubes	End to End connections	Output $\Delta T50^{\circ}\text{C}$ Watts/BTU's	Output $\Delta T60^{\circ}\text{C}$ BTU's	Stock or made to order
	H	W	D					
DR005	1800	325	92 - 117	6	325	421 / 1436	1821	✓
DR005	1800	525	92 - 117	10	525	700 / 2388	3028	✓
DR005	1800	725	92 - 117	14	725	979 / 3340	4235	✎
DR005	1800	925	92 - 117	18	925	1257 / 4289	5438	✎

Serenade is a vertical contemporary design radiator, manufactured from high quality mild steel with finish options of chrome, textured matt black & white. Please see pages 150 for colour options.



Optional Accessory

Towel Bar - White, Chrome or Black

AC039A (266mm wide)

AC039B (375mm wide)



VL014



30sq + 40 x 10sq mm

For other valve options see page 148



Serenade	Dimensions (mm)			Bar config	End to end connections	Output		Output		Stock or made to order			
	MS	15	C			H	W	D	Δ T50°C Watts/BTU's		Δ T60°C BTU's		
									chrome		paint	chrome	paint
DR008				1200	252	70	5	252	242 / 826	367 / 1252	1047	1588	✓
DR008				1200	358	70	7	358	339 / 1157	515 / 1757	1467	2228	✓
DR008				1800	252	70	5	252	351 / 1198	533 / 1819	1519	2306	✓
DR008				1800	358	70	7	358	491 / 1675	746 / 2545	2124	3227	✓

FLY LINE VERTICAL Wall Mounted DR003



Fly Line is a strong, minimalist design ideal for contemporary properties. These radiators come with a choice of single or double panel versions with the double panel offering an increased heat output. Fly Line Vertical and Horizontal are available in a variety of size options and come as standard in white or anthracite. Please see pages 150 for colour options, available on single panel versions only.



Double panel design Fly Line Vertical in white



Optional Accessory for single panel Vertical Fly Line

Towel Bar - Stainless Steel

AC032 - 450mm wide



VL003



38mm

70 x 11mm

For other valve options see page 148

Fly Line Vertical MS 15 C	Dimensions (mm)			No of Sections	End to End Connections	Output $\Delta T50^{\circ}\text{C}$ Watts/BTU's	Output $\Delta T60^{\circ}\text{C}$ BTU's	Stock or made to order
	H	W	D					
DR003 (single panel)	1800	224	71	3	224	402 / 1372	1740	✓
DR003 (single panel)	1800	376	71	5	376	670 / 2286	2899	✓
DR003 (single panel)	1800	528	71	7	528	938 / 3200	4058	✓
DR003 (single panel)	1800	680	71	9	680	1206 / 4115	5218	✓
DR003DP (double panel)	1800	224	71	3	224	627 / 2139	2712	✓
DR003DP (double panel)	1800	376	71	5	376	1045 / 3566	4522	✓
DR003DP (double panel)	1800	528	71	7	528	1463 / 4992	6330	✓
DR003DP (double panel)	1800	680	71	9	680	1881 / 6418	8138	✓



Double Panel
Fly Line Horizontal in Anthracite



VL003



38mm



70 x 11mm

For other valve options see page 148

Fly Line Horizontal			Dimensions (mm)			No of Sections	Pipe Centres	Output $\Delta T50^{\circ}\text{C}$ Watts/BTU's	Output $\Delta T60^{\circ}\text{C}$ BTU's	Stock or made to order
MS	15	C	H	W	D					
			452	900	63	6	850	420 / 1433	1817	✓
			452	1200	63	6	1150	552 / 1883	2388	✓
			604	900	63	8	850	560 / 1911	2423	✓
			604	1200	63	8	1150	736 / 2511	3184	✓
			452	900	112	6	850	654 / 2231	2829	✓
			452	1200	112	6	1150	858 / 2927	3711	✓
			604	900	112	8	850	872 / 2975	3772	✓
			604	1200	112	8	1150	1144 / 3903	4949	✓

LURE SINGLE Wall Mounted DR020



A statement piece that oozes sophistication and practical good looks, with a bank of closely fitting oval tubes to provide aesthetic appeal and efficient heat output. Available in chrome or white. Please see pages 150 for colour options.



VL003



32mm



25 x 50mm oval

For other valve options see page 148

Unique oval tubing



Lure Single			Dimensions (mm)			Bar config	End to end connections	Output $\Delta T50^{\circ}\text{C}$ Watts/BTU's		Output $\Delta T60^{\circ}\text{C}$ BTU's		Stock or made to order
MS	15	C	H	W	D			chrome	white	chrome	white	
DR020	1800	352	83	6	352	497 / 1696	751 / 2562	2151	3249	✓		

A modern designer radiator with twin rows of oval tubes for elegance and high output available in white or anthracite.

Manufactured from mild steel, suitable for closed heating systems and with a 15 year guarantee.



VL003



∅ 32mm

□ 25 x 50mm oval

For other valve options see page 148

Lure Double			Dimensions (mm)			Bar config	End to end connections	Output Δ T50°C Watts/BTU's White or Anthracite	Output Δ T60°C BTU's White or Anthracite	Stock or made to order
MS	15	C	H	W	D					
DR020DP	1800	352	105-110	6	352	2161 / 7373	9349	✓		

MODE II Wall or Floor Mounted CN027

Contemporary styling with sleek rounded tubes. Mode II has all the attributes of a great column radiator with edgy attitude. These wall hung radiators will complement many areas of the home. Available in white RAL 9016 and Metallic Anthracite as standard. Please see page 150 for other colour options.

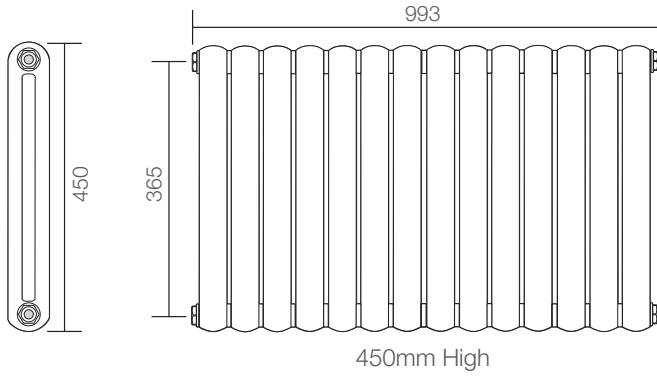

450mm High

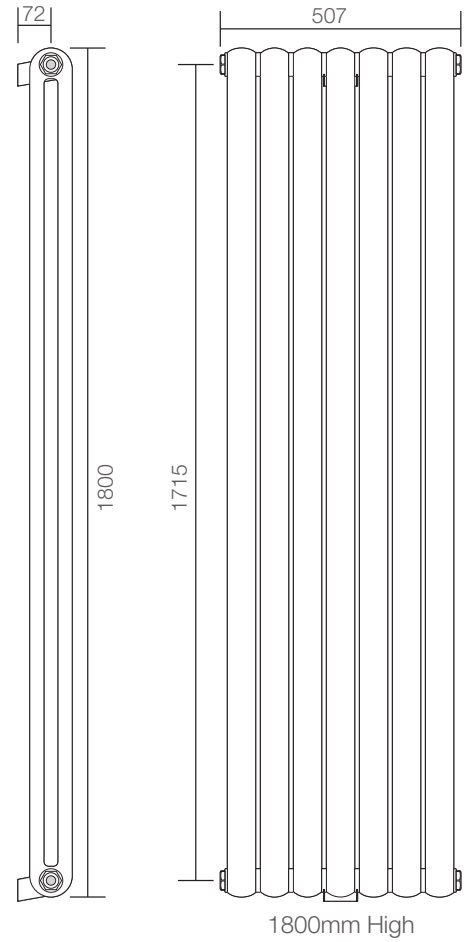

1800mm High



Metallic Anthracite option (non-textured)

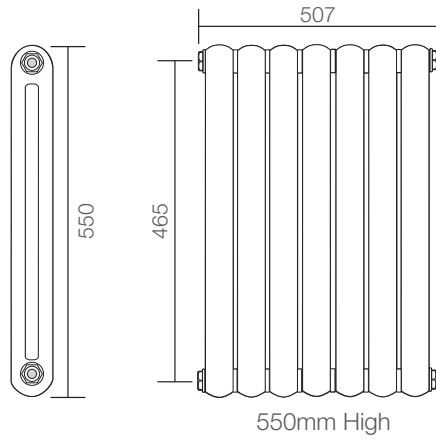

550mm High

Optional Accessories

Towel Bar - White, Chrome or Anthracite

AC034A (60 x 200mm wide)

AC034B (60 x 340mm wide)

AC034C (60 x 480mm wide)

Feet - White or Anthracite

AC038



VL003

VL004



For other valve options see page 148



Mode II MS 15 C	Dimensions (mm)			Number Of Sections	Output $\Delta T50^{\circ}\text{C}$ Watts/BTU's	Output $\Delta T60^{\circ}\text{C}$ BTU's	Stock or made to order
	H	W	D				
CN027	450	507	90	7	398 / 1358	1722	✓
CN027	450	785	90	11	625 / 2133	2705	✓
CN027	450	993	90	14	796 / 2716	3444	✓
CN027	450	1202	90	17	966 / 3296	4179	✓
CN027	550	507	90	7	505 / 1723	2185	✓
CN027	550	785	90	11	793 / 2706	3431	✓
CN027	550	993	90	14	1009 / 3443	4366	✓
CN027	550	1202	90	17	1226 / 4183	5304	✓
CN027	1800	229	90	3	922 / 3146	3989	✓
CN027	1800	370	90	5	1538 / 5248	6654	✓
CN027	1800	507	90	7	2153 / 7346	9315	✓





Mode suits traditional properties, yet also looks great in contemporary settings.

Available in a wide range of sizes, so you can choose a radiator which exactly suits your space and required heat output.

The standard colour finish is white RAL 9016. Other RAL colours are available. Please see page 150 for other colour options.

Please note, contemporary colours available on 2 & 3 column only.

Wall brackets are included, feet and other fixing accessories are detailed on the next pages. For other valve options see page 148

Standard Stock Sizes (opposite)

We stock 2, 3 and 4 column radiators. Heights range from 300mm great for under window sills, to a 1800mm tall version. There are many sizes in between.

Non Standard Sizes (next pages)

Non standard sizes include 5 and 6 columns ranging from 300mm - 2000mm high and detailed on the next pages. Non stocked and colour finish options have an eight week lead time.



VL004 Arne Thermostatic option



VL008



For other valve options see page 148

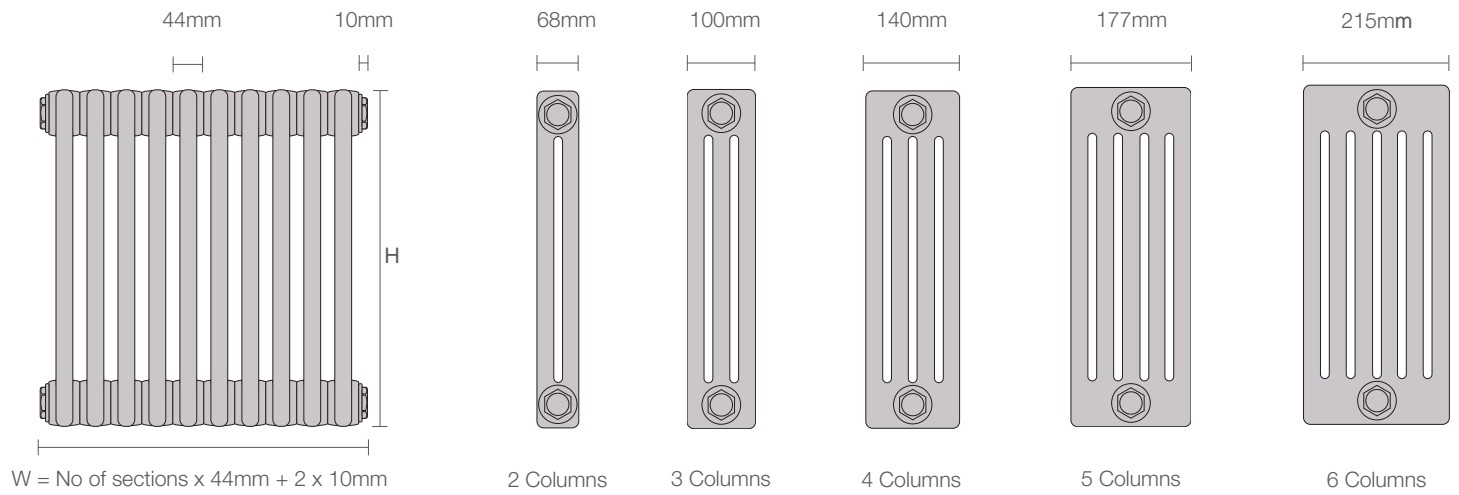

Mode MS 15 C	Dimensions (mm) excluding feet			Number Of Sections	Output $\Delta T50^{\circ}\text{C}$ Watts/BTU's	Output $\Delta T60^{\circ}\text{C}$ BTU's	Stock or made to order
	H	W	D				
2 Column Radiators							
2C-050-10	500	460	68	10	371 / 1266	1605	✓
2C-050-18	500	812	68	18	688 / 2347	2976	✓
2C-050-22	500	988	68	22	817 / 2788	3535	✓
2C-060-10	600	460	68	10	440 / 1501	1903	✓
2C-060-14	600	636	68	14	616 / 2102	2665	✓
2C-060-18	600	812	68	18	792 / 2702	3426	✓
2C-060-22	600	988	68	22	968 / 3303	4188	✓
2C-060-24	600	1076	68	24	1056 / 3603	4569	✓
2C-060-28	600	1252	68	28	1232 / 4204	5331	✓
2C-180-6	1800	284	68	6	774 / 2641	3349	✓
2C-180-8	1800	372	68	8	1032 / 3521	4465	✓
2C-180-10	1800	460	68	10	1290 / 4401	5580	✓
2C-180-12	1800	548	68	12	1548 / 5282	6698	✓
3 Column Radiators							
3C-050-14	500	636	100	14	720 / 2457	3115	✓
3C-050-18	500	818	100	18	926 / 3160	4007	✓
3C-050-22	500	988	100	22	1131 / 3859	4893	✓
3C-050-24	500	1076	100	24	1234 / 4210	5338	✓
3C-050-28	500	1252	100	28	1440 / 4913	6230	✓
3C-060-10	600	460	100	10	609 / 2078	2635	✓
3C-060-14	600	636	100	14	852 / 2907	3686	✓
3C-060-18	600	812	100	18	1097 / 3743	4746	✓
3C-060-20	600	900	100	20	1218 / 4156	5270	✓
3C-060-24	600	1076	100	24	1462 / 4988	6325	✓
3C-060-30	600	1340	100	30	1827 / 6234	7905	✓
3C-075-10	750	460	100	10	750 / 2559	3245	✓
3C-075-14	750	636	100	14	1050 / 3583	4543	✓
3C-075-18	750	818	100	18	1350 / 4606	5840	✓
3C-075-22	750	988	100	22	1650 / 5630	7139	✓
3C-075-26	750	1164	100	26	1950 / 6653	8436	✓
3C-180-8	1800	372	100	8	1412 / 4818	6109	✓
3C-180-10	1800	460	100	10	1764 / 6019	7632	✓
3C-180-12	1800	548	100	12	2117 / 7223	9159	✓
4 Column Radiators							
4C-030-20	300	900	140	20	850 / 2900	3677	✓
4C-030-30	300	1340	140	30	1275 / 4350	5516	✓
4C-060-14	600	636	140	14	1147 / 3914	4963	✓
4C-060-18	600	818	140	18	1475 / 5033	6382	✓
4C-060-20	600	900	140	20	1638 / 5589	7087	✓
4C-060-24	600	1076	140	24	1966 / 6708	8506	✓
4C-075-14	750	636	140	14	1417 / 4835	6131	✓
4C-075-18	750	818	140	18	1822 / 6217	7883	✓
4C-075-22	750	988	140	22	2227 / 7599	9636	✓
4C-075-26	750	1164	140	26	2632 / 8980	11387	✓



This service gives the opportunity to order non standard sizes. Choose from wall or floor standing. These radiators are supplied in white RAL 9016. Coloured finishes are available, please see the colour chart on page 150. Please note, contemporary colours available on 2 & 3 column only. The lead time for delivery is approximately eight weeks. The sections cannot be joined on site. We only supply complete radiators, practical considerations need to be given to weight, carriage, handling and accessibility. Where necessary large radiators can be supplied in module format. Contact our sales office for further information.



VL003



For other valve options see page 148

Accessories for Mode Column Radiators

Stock
or made
to order

Calculations for Sizing a Radiator...



Column Radiator Feet AC028



Adjustable Feet AC024
Height from 90mm to 120mm.
Must only be used with top
retaining stay.



Base Plate Cover AC025
For use with adjustable feet (above).



Top Retaining Stay AC026
For use with adjustable feet.



Heavy Duty Wall Brackets
Available for 2 to 6 column radiators.



Standing Brackets
For use with glass walls etc...



Welded Feet
(Increase height by 100mm)
Up to 20 sections requires two feet
21 to 40 sections three feet
41 to 58 sections four feet



Required output is 1200 watts

Space available is 1000 mm high x 750 mm wide. Approx radiator dimensions 900mm high x 600mm wide.
(Taking into account space for valves)

Number of sections possible

Width (600mm) divide by 45mm per section + allowance for each side.
 $600 - 24$ divided by $45 = 12$ sections.

Heat output per section

Divide your required output by sections.
 1200 watts divided by $12 = 100$ watts per section.

Selecting your radiator section

$4-750 @ 102$ watts per section. Therefore 12 sections $@ 102$ per section = 1224 watts @ 50 degrees C delta T.

Price calculation

$12 \times \pounds 40.00 = \pounds 480.00$ ex VAT
Plus feet if floor standing and any other non standard support brackets you may require.

Dimensions

The nominal overall length of a radiator = number of section x 45mm = 24mm for reducing bushes (12mm each end).
Subject to manufacturing tolerance of +/- 0.6mm per section.

Mode Sections MS 15 C	Dimensions (mm) excluding feet		Output $\Delta T_{50^{\circ}\text{C}}$ Watts/BTU's	Output $\Delta T_{60^{\circ}\text{C}}$ BTU's	Stock or made to order
	H	D			
2 Column Section					
2-300	300	68	24 / 82	104	☞
2-400	400	68	31 / 106	134	☞
2-500	500	68	37 / 126	160	☞
2-600	600	68	44 / 150	190	☞
2-750	750	68	55 / 188	238	☞
2-900	900	68	65 / 222	282	☞
2-1000	1000	68	72 / 246	312	☞
2-1200	1200	68	86 / 293	372	☞
2-1500	1500	68	108 / 369	468	☞
2-1800	1800	68	129 / 440	558	☞
2-2000	2000	68	144 / 491	623	☞
3 Column Section					
3-300	300	100	33 / 113	143	☞
3-400	400	100	42 / 143	181	☞
3-500	500	100	52 / 177	224	☞
3-600	600	100	61 / 208	264	☞
3-750	750	100	75 / 256	325	☞
3-900	900	100	90 / 307	389	☞
3-1000	1000	100	99 / 338	429	☞
3-1200	1200	100	118 / 403	511	☞
3-1500	1500	100	147 / 502	637	☞
3-1800	1800	100	177 / 604	766	☞
3-2000	2000	100	197 / 672	852	☞
4 Column Section					
4-300	300	140	43 / 147	186	☞
4-400	400	140	56 / 191	242	☞
4-500	500	140	69 / 235	298	☞
4-600	600	140	82 / 280	355	☞
4-750	750	140	102 / 348	441	☞
4-900	900	140	121 / 413	524	☞
4-1000	1000	140	134 / 457	579	☞
4-1200	1200	140	159 / 543	689	☞
4-1500	1500	140	197 / 672	852	☞
4-1800	1800	140	235 / 802	1017	☞
4-2000	2000	140	260 / 887	1125	☞
5 Column Section					
5-300	300	177	52 / 177	224	☞
5-400	400	177	68 / 232	294	☞
5-500	500	177	83 / 283	359	☞
5-600	600	177	98 / 334	424	☞
5-750	750	177	121 / 413	524	☞
5-900	900	177	143 / 488	619	☞
5-1000	1000	177	158 / 539	683	☞
5-1200	1200	177	188 / 641	813	☞
5-1500	1500	177	232 / 792	1004	☞
5-1800	1800	177	277 / 945	1198	☞
5-2000	2000	177	307 / 1048	1329	☞
6 Column Section					
6-300	300	215	63 / 215	273	☞
6-400	400	215	82 / 280	355	☞
6-500	500	215	101 / 345	437	☞
6-600	600	215	120 / 409	519	☞
6-750	750	215	148 / 505	640	☞
6-900	900	215	175 / 597	757	☞
6-1000	1000	215	193 / 659	836	☞
6-1200	1200	215	229 / 781	990	☞
6-1500	1500	215	282 / 962	1220	☞
6-1800	1800	215	334 / 1140	1446	☞
6-2000	2000	215	369 / 1259	1596	☞



be
different

VOGUE Electric Products

Vogue UK have a comprehensive range of electrical products including –

Towel Warmers

Radiators

Electric Underfloor Heating

Envirovent fans



ECO Wall Mounted ER001



Eco is a cost effective electric radiator which allows you to control room temperature. It also has an integral economy function and frost protection. Electrical components are covered by a two year warranty.

Eco (IP24)			Dimensions (mm)			Number of Sections	Power wattage	Stock or made to order
MS	15	E	H	W	D			
			580	370	80	4	500	👉
			580	530	80	6	750	👉
			580	690	80	8	1000	👉
			580	770	80	9	1250	👉
			580	930	80	11	1500	👉



A sleek unit with digital programmable technology. The programmer can be safety locked to avoid accidental alterations. Stromboli has a comfort, economy and frost protection settings, great for houses unoccupied for weeks at a time. Electrical components are covered by a two year warranty.

Stromboli (IP20)	Dimensions (mm)			Number of Sections	Power wattage	Stock or made to order			
	MS	15	E				H	W	D
ER002				580	470	100	4	500	
ER002				580	630	100	6	750	
ER002				580	790	100	8	1000	
ER002				580	870	100	9	1250	
ER002				580	1030	100	11	1500	

MODE ELECTRIC Wall or Floor Mounted



The Mode electric radiator compliments traditional and contemporary interiors to a tee. Manufactured from mild steel, supplied as standard in a white RAL 9016 powder coated finish. Most RAL colours are available as a special order. Available in seven stock sizes, 2 - 3 weeks delivery wall mounted. 4 - 6 weeks floor mounted with welded feet. Bespoke sizes can be arranged. Electrical components are covered by a two year warranty.

Electric Controls

- White as standard.
- Matt chrome finish is available.
- Temperature control between 10°C and 65°C.
- Led power indicator with frost protection.



Mode MS 15 E	Dimensions (mm)			Number of sections	Power wattage	Stock or made to order
	H	W	D			
2C-1800-12E	1802	634	63	12	1500	✓
3C-0600-10E	602	544	101	10	900	✓
3C-0600-14E	602	724	101	14	1200	✓
3C-0600-20E	602	994	101	20	1500	✓
4C-0600-18E	602	904	139	18	1500	✓
4C-0300-30E	302	1444	139	30	1500	✓
4C-0600-24E	602	1174	139	24	2000	✓



Image showing chrome version



Now complete with remote control



The Comby Dryer is the best of both worlds; it dries towels and clothes quickly, whilst heating the bathroom at the same time. Practical and energy saving, the Comby Dryer has three programs to set. Allowing activation of the towel rail in the morning, evening or both. By simply adjusting the air guide panel to a suitable position, hot air is also able to be directed to where it is needed most. It also features a "Boost" button on the control panel, enabling more widespread ventilation to be achieved.



23 + 31 x 40mm D Section * The first value refers to the towel warmer; the second to the blower

Comby Dryer MS 15 E	Dimensions (mm)			Bar config	Pipe centres	*Output Δ T50°C Watts/BTU's	Output Δ T60°C BTU's	Stock or made to order
	H	W	D					
MD082 White	1441	500	94-126	7-4-11	450	750 + 1000* / 5971	7571	✓
MD082 Chrome	1441	500	94-126	7-4-11	450	500 + 1000* / 5118	6490	✓

COMFORT Wall Mounted EL028



Comfort is ideal for compact situations. It is electric only and is manufactured in high quality mild steel, chromed to a mirror finish. Electrical components are covered by our two year warranty. Has a rating of IP55.

Detail shot to show angled bars

Comfort		Dimensions (mm)			Power wattage	Stock or made to order	
MS	15	E	H	W			D
EL028			719	545	103	120	✓

Uncomplicated and chic. The linear styling of Simplicity adds a sense of sophistication to any room. Slimline and discreet it provides the comfort of warm fluffy towels or bathrobes. This is electric drylined only and is manufactured in high quality stainless steel. Electrical components are covered by our two year warranty. IP44 when installed as per installation instructions.



Delivered complete, no cover shroud necessary.

Simplicity II	Dimensions (mm)	Description	Power W	Stock or made to order
SS 2 E	H			
EL040 Round	1100	Round tube 30mm Ø	28-30	✓
EL040 Round	1500	Round tube 30mm Ø	42-44	✓
EL040 Round	1800	Round tube 30mm Ø	52-55	✓
EL045 Cube	1100	Square tube 30 x 30mm	33-35	✓
EL045 Cube	1500	Square tube 30 x 30mm	49-52	✓
EL045 Cube	1800	Square tube 30 x 30mm	64-68	✓

SILENT Design 100

- Silent elastic blocks
- Sealed for life ball bearings
- Back draught shutter and airflow guide vanes
- High performance and quality
- Incredibly silent running
- Energy efficient
- 8 Watts / 230 Volts
- IP45 rated



A range of 100mm domestic axial extract fans for wall or ceiling installations, designed to solve ventilation problems in WC's and bathrooms. Fitted with motors mounted on silent elastic blocks, the fans deliver incredibly silent running and exceptional performance and stylish design.

ECO dMEV

- Up to 6 adjustable trickle speed settings
- Timer, humidity sensor and pull cord models
- Complies with Building Regulations. Part F for system 3 Continuous Mechanical Extract
- SAP Appendix Q eligible achieving a low specific fan power of 0.28 W/l/s
- Incredibly silent running - Below 20 dB(A)
- One fan for all situations, both walls and ceilings
- Low Energy DC 1.5 Watts - Low voltage version available
- 4 Interchangeable front panel trims



The ECO dMEV has been designed and developed to offer the market a constant volume, continuously running, decentralised extract fan for the lowest power consumption, the lowest noise and lowest lifecycle costs.

SILENT MV

- Sound absorbent insulation
- Incredibly silent running
- 360° rotating connection box
- Sealed for life ball bearings
- Fitted with a two speed motor
- Complies with building regulations
- High performance with flexible location
- Easy installation and maintenance
- IP44 rated



The SILENT MV fan range offers one of the most versatile fan systems on the market today. Due to its flexibility it can be used in a multitude of small and medium fan installations. Especially advantageous in applications where the system may be running for long periods throughout the day, the acoustic benefits of the SILENT MV fans ensure that optimum comfort is achieved without the disturbance of noisy ventilation systems.

SILENT 100

- Also available in silver on silent elastic blocks
- Sealed for life ball bearings
- Back draught shutter and airflow guide vanes
- High performance and quality
- Incredibly silent running
- Significant energy savings
- 8 Watts / 230 Volts or 13 Watts / 12 Volts options
- IP45 / IP57 SELV version



100mm domestic axial extract fans for wall or ceiling installations. Designed to solve ventilation problems in WC's and bathrooms. Fitted to motors mounted on silent elastic blocks, fans are incredibly silent running and exceptional performance.

Optional Kits



ENV-WALL KIT



ENV-CEILING KIT



ENV-SOFIT KIT



ENV-3M FLEX



ENV-6M FLEX

Fan	Description	Airflow rates l/s (m³/h)	Stock or to order
Silent Design 100			
SILDES100 S	White Standard Model	22 (85)	✓
SILDES100 SS	Silver Standard Model	22 (85)	✓
SILDES100 T	White Timer Model	22 (85)	✓
SILDES100 TS	Silver Timer Model	22 (85)	✓
SILDES100 HT	White Adjustable Humidity Sensor Model	22 (85)	✓
SILDES100 HTS	Silver Adjustable Humidity Sensor Model	22 (85)	✓
Eco dMEV			
Eco dMEV S	Standard Model	18 (65)	✎
Eco dMEV T	Adjustable Run-On Timer Model	18 (65)	✎
Eco dMEV HT	Adjustable Humidity Sensor and Timer Model	18 (65)	✎
Eco dMEV HTP	Pull Cord Adjustable Humidity Sensor and Timer Model	18 (65)	✎
Eco dMEV S SELV	Standard (SELV) Model	18 (65)	✎
Eco dMEV T SELV	Adjustable (SELV) Run-On Timer Model	18 (65)	✎
Eco dMEV HT SELV	Adjustable (SELV) Humidity Sensor and Timer Model	18 (65)	✎
Eco dMEV HTP SELV	Pull Cord Adjustable (SELV) Humidity Sensor and Timer Model	18 (65)	✎
Silent MV			
SILMV 160100 S	Silent 2 speed in line fan	50 (80)	✓
SILMV 160100 T	Silent single speed inline fan with adjustable timer	50 (80)	✓
SILMV 250100 S	Silent 2 speed in line fan	50 (80)	✎
SILMV 250100 T	Silent single speed inline fan with adjustable timer	50 (80)	✎
Silent 100			
Silent-100 S	Standard Model	26 (95)	✓
Silent-100 T	Adjustable Timer Model	26 (95)	✓
Silent-100 IT	Intelligent Timer Model	26 (95)	✎
Silent-100 HT	Adjustable Humidity Sensor Model	26 (95)	✓
Silent-100 PIR	PIR Model	26 (95)	✎
Silent-100S 12V	Standard Model (SELV)	26 (95)	✎
Silent-100 T 12V	Adjustable Timer Model (SELV)	26 (95)	✎
Silent-100 TP 12V	Adjustable Timer and Pullcord Model (SELV)	26 (95)	✎
Silent-100 P 'EV' (12V 50)	Pullcord (SELV)	26 (95)	✎
Silent-100 HTP 12V	Adjustable Timer, Humidity Sensor and Pullcord Model (SELV)	26 (95)	✎
Silent-100 SS SILVER	Silver Standard Model	26 (95)	✓
Silent-100 ST SILVER	Silver Adjustable Timer Model	26 (95)	✓
Optional Kits			
ENV-WALL KIT	Wall Grill and pipe		✓
ENV-CEILING KIT	Ceiling Vent, 6M Flex and 2 flex ties		✓
ENV-SOFIT KIT	Wall grill, 3M Flex and 2 flex ties		✓
ENV-3M FLEX	3 metre flex 100 dia		✓
ENV-6M FLEX	6 metre flex 100 dia		✓

ELECTRIC Underfloor Heating

There is nothing that quite matches the comfort of warm feet when getting out of the bath or shower, especially in the cold winter months! Imagine stepping onto warm tiles controlled to the temperature you prefer.

Electric underfloor heating works by gently warming the mass of floor which in turn warms the rest of the room. Our underfloor heating kit is quick and easy to install. Ideally timed when you are fitting a new kitchen or bathroom. Electrical components are covered by a two year warranty.

The Underfloor Heating Kit Includes

- The correct size heating mat.
- Digital touch screen timer and thermostat.
- Floor sensor and floor sensor mounting pipe.
- Multimeter to check installation at every stage.
- Comprehensive installation manual and control card.



Putting You in Control...

The digital touch screen, completely programmable timer and thermostatic controller enables you to fully regulate the temperature and control when the heating is on or off. The manual override means at the touch of a button the temperature can be higher or lower to suit as and when it is needed.

EUFH E 2	Area Metre(s) Square	Rated Power Wattage per mat	Stock or made to order
EUFH150-01.0	1.0	150	✓
EUFH150-01.5	1.5	225	✓
EUFH150-02.0	2.0	300	✓
EUFH150-02.5	2.5	375	✓
EUFH150-03.0	3.0	450	✓
EUFH150-03.5	3.5	525	✓
EUFH150-04.0	4.0	600	✓
EUFH150-04.5	4.5	675	✓
EUFH150-05.0	5.0	750	✓
EUFH150-06.0	6.0	900	✓
EUFH150-07.0	7.0	1050	✓
EUFH150-08.0	8.0	1200	✓
EUFH150-09.0	9.0	1350	✓
EUFH150-10.0	10.0	1500	✓
EUFH150-12.0	12.0	1800	✓





be
choosy
choosy

VOGUE

Additions and Accessories

So you've found your perfect towel rail... Now add the perfect finishing touches. From high quality valves to the latest technology in heated electric elements...



ELECTRIC ELEMENT ONLY Prices



Standard Element

IP55 Suitable for zones 1 and 2 of the bathroom.

Each standard element contains an internal preset over the temperature switch and fail safe fuse. There is no thermostatic control although a suitably rated rheostat (CD-VR) will give thermal control when fitted into the electrical supply circuit.

Available as a summer kit for dual fuel options. See page 146 for tee piece AC003

Product	Watts
EE002	75w
EE002	100w
EE002	125w
EE002	150w
EE002	200w
EE002	300w
EE002	400w
EE002	600w



Heat Sensor Element

IPX5 suitable for zones 1 and 2 of the bathroom.

Five temperature settings ranging from 30°C to 60°C. The device displays the temperature to which it is currently set and indicates the status of the heating cycle.

Optional accessory is the Heat Sensor Element Cover Shroud - AC040, to hide the cable - See page 146

Can be used when depth from wall to centre is the maximum of 70mm.

Not suitable for use with timer AC013

Product	Watts
EE006	200w
EE006	300w
EE006	400w
EE006	600w
EE006	800w
EE006	1000w



Electronique Element

IP66 Suitable for zones 1 and 2 of the bathroom.

The standard Electronique element is set to a constant surface temperature of 52°C, with no need for external controls. In the fully loaded towel warming mode it will act to reduce power and save running costs. In space heating mode it will increase the power to deliver background heat needed to the maximum of its rated capacity. A safe to touch system, with safety measures incorporated.

Available as a summer kit for dual fuel options. See page 146 for tee piece AC003

Product	Watts
EE001A	200w
EE001A	400w
EE001A	600w



Remote Controlled Heat Element

IPX4 suitable for zones 1 and 2 of the bathroom.

Negative Temperature Coefficient technology

7 day programmable element with remote control switches the towel rail on and off when you want, at the temperature you want. Eco, boost and safety lock features included, and manual override allows you total flexibility when needed. Can be retro fitted to existing electric or dual fuel multirail towel rails.

*Please note, Element only suitable for vertical installation

Available as a summer kit for dual fuel options. See page 146 for tee piece AC003

Product	Watts
EE005	300w
EE005	600w
EE005	900w



Contract Fixed Heat / LST Electronique Element

IP55 Suitable for zones 1 and 2 of the bathroom.

Fixed Heat is designed as an energy saving element to control temperature and consume only the correct amount of power required. It maintains your pre-set temperature whether the rail is in a cold bathroom empty or fully loaded with towels. Fixed Heat for LST (low surface temperature) of 43°C must be chosen to comply with LST legislation for use in public buildings, hospitals and care homes.

Product	Watts
EE001C	200w
EE001C	400w
EE001C	600w



Standard Rail Option (H) and (C) Multirail Option (H) and (C)

Heating Only Options



Heating and Hot Water this is suitable for all heating and hot water systems. For connection to either direct (open) or indirect (closed) central heating systems.



Suitable for indirect (closed) central heating circuits only. It cannot be installed on an open circuit due to the product containing ferrous (steel) parts.



Standard Rail Option (E)

Multirail Option (E)

Electric Only Options



A completely independent unit requiring only a fused spur electric connection. Thermal transfer fluid is heated by an electric element within the towel rail.



Standard Rail Option (D)

Multirail Option (D)

Dual Fuel Options



The towel rail has the capability to run from a central heating circuit or an electric element. Handy in the summer months when the central heating is turned off.



Internal view

Rear external view

Electric Dryline Option



Electric dryline technology, with the towel warmer not containing any fluids. The towel warmer is heated using a silicone heater cable, exiting the towel warmer via a 3 core cable. This can then be attached to a fuse spur. Only available on specific models, please contact our sales office on +44(0)1902 387000 for further details. POA.

Please Note:

When using the electric element only (ie; during summer), allowance must be made for thermal expansion within the product by having the 'return' radiator valve left partially open. The 'flow' radiator valve must be closed to prevent back flow through the system. Both valves should be opened and balanced when the central heating system is operative, (i.e. during winter).

Steel Rails - Must be installed in accordance with BS7593 where a corrosion inhibitor is used.

Brass Rails - Caution where water softener is installed, as this could cause dezincification (material is attacked ie. zinc eaten away by aggressive water).

Brass towel rails are manufactured using dezincification resistant brass, however it should be understood that the term 'resistant' does not entirely preclude the possibility of dezincification occurring. If you intend to install the product on an open (DHW) circuit, make reference to your local water authority to ensure dezincification has not previously occurred. Towel rails manufactured from brass tubing should not be installed on an open circuit if a water softener is present. Water analysis to determine the likelihood of dezincification is available at cost.

Models suitable for indirect (closed) circuits only cannot be installed on an open circuit due to the item containing ferrous (steel) parts. Product compatibility is the responsibility of the installer.

FITTED ELECTRIC & DUAL FUEL Pricing

This section contains a range of elements with price supplements for electric and dual fuel models. Please add the price of your element to the model you choose and we will build it for you.



Standard Element IP55 Code EE002
A benchmark element to suit each size of product.



Electronique Element IP66 Code EE001A
Maintains surface temperature of product to 52 °C.



Heat Sensor Element IPX5 Code EE006*
An electronic temperature sensor control.



Remote Controlled Heat Element IPX4 Code EE005
NTC – Negative Temperature Coefficient technology. Remote controlled programmable element for adjustable temperature control.

*Optional cover shroud available AC040, See page 146



Fixed Heat / LST Electronique Element IP55
Code EE001C

Ideal for LST applications where surface temperatures need to be guaranteed.

* Dual fuel models will also be supplied with a conversion tee where applicable. This can be used with VL013 valves for a multitrail. Alternatively to a conversion tee dual fuel valves VL015 can be used.

All the images of elements depict electric only versions. Dual fuel configurations may vary including element positioning. The appropriate standard versions will be supplied in all cases unless advised otherwise.

Electric towel rails are filled with a glycol ethylene / water mix to strict guidelines. This improves the thermal transfer rate and acts as a corrosion inhibitor.

All electric and dual fuel towel rails must be fitted by a qualified person.

The elements are fitted on the right hand side as standard. They can be left hand mounted on request, on certain rails only.

This section contains information on electrical safety.

IEE Wiring Regulations have identified the following zones and IP ratings to ensure safety.



IP Zoning

ZONE 0	Inside the bath or shower. Any fitting here must be SELV (max 12v) and a minimum rating of IPX7. (Protection against immersion in water).
ZONE 1	Above the bath or shower to a height of 2.25m. A minimum rating of IPX4 is required * See note 1.
ZONE 2	The area stretching to 0.6m outside the bath or shower and above the bath or shower if over 2.25m. A minimum rating of IPX4 is required * See note 1.
OUTSIDE ZONES	Anywhere outside zones 0, 1, and 2. Where water jets are not used for cleaning purposes, the general rules BS7671 apply. * See note 1.

All final circuits require 30mA RCD protection.

Notes

- In zones 1 and 2 if there is a likelihood of water jets being used for cleaning purposes a minimum of IPx5 is required.
- Where ceiling heights exceed 2.25m, the zones are effectively up to 3m, beyond 3m the walls are out of scope.
- Basins are not covered, however they are usually considered zone 2.
- If the space underneath a bath cannot be accessed without tools that space is considered out of zone.
- Information contained on this page is for guidance only. Please refer to current IEE Regulations or a qualified electrician.

IP Rating Guide

The IP (ingress protection) rating given to an enclosure, states the degree of protection it offers by means of two digits. A summary of these are detailed below. For more information please see IEC 529: 1989 BSEN 65029:1992.

First Digit

Protection against solid foreign objects and access to hazardous parts.

At the lowest of seven levels is 0, this means no protection is offered. At the highest level 6, there shall be no entry of dust particles.

Second Digit

Protection against entrance of water on a progressive scale. At level 1 dripping water shall have no effect. at level 6 water from powerful jets against the enclosure shall have no effect.

The letter X can be used in place of the first digit or second digit to indicate that tests have not been carried out or are not applicable.

0		No protection.	0		No protection.
1		Protected against solid objects larger than 50mm e.g. accidental touch by hands.	1		Protected against vertically falling drops of water e.g. condensation.
2		Protected against solid objects larger than 12.5mm e.g. fingers.	2		Protected against direct sprays of water up to 15° from the vertical.
3		Protected against solid objects larger than 2.5mm e.g. tools and cables.	3		Protected against direct sprays of water up to 60° from the vertical.
4		Protected against solid objects larger than 1mm.	4		Protected against water splashed from all directions - limited ingress permitted.
5		Protected against dust (no harmful deposits).	5		Protected against low pressure jets of water from all directions - limited ingress permitted.
6		Totally protected against dust.	6		Protected against strong jets of water e.g. for use on ship decks - limited ingress permitted.
			7		Protected against the effects of temporary immersion in water between 150mm and 1m.
			8		Protected against continuous submersion at a specified depth.

IEC 529, bs en 60529 does not apply to any risk of explosion or conditions such as humidity, corrosive gases, fungi or vermin. In certain cases equipment designed to be mounted in an enclosure will contribute towards the stated IP rating (eg Push buttons mounted in an enclosure). Different parts of enclosures can have different degrees of protection and still conform to the standard (e.g. Enclosures with pre-drilled conduit entry. All information strictly for guidance only, please refer to regulations and manufacturers for information if you are in any doubt.

ACCESSORIES



AC001

Auto air vent.

Can only be fitted in manufactured products. Must be specified at point of order.



AC002

Ball vent.



AC003

Conversion tee for dual energy radiators.



AC004

Valve sleeves.



AC005

Connection tubes.

AC006

Street elbow connection tubes.

AC007

Electric element shroud covers. Shown as standard in chrome. Other finishes are available, please contact the sales office for a quote.



*Please be aware that some cover shrouds conceal the element block and cable but NOT the service nut. If unsure, please ask your Dealer for more information prior to ordering.



AC035

Blanking Plug with Aroma Oil Dish.

AC040

Heat Sensor Element Cover Shroud

Can be used when depth from wall to centre is the maximum of 70mm.



AC060

Air vent cap.

Product	Description	Stock or made to order
2		
AC001	1/8" BSP M.I. Self sealing auto vent. All models are fitted with manual air vents. To be specified on order	✓
AC002	1/2" BSP M.I. Decorative air vent and plug	✓
AC003	Three point 1/2" BSP adaptor. For electric element and radiator valve link	✓
AC004	19 mm Ø x 100 mm long, electroplated to match towel rail and valves	✓
AC005	15 mm Ø x 150 mm long	✓
AC005	22 mm Ø x 150 mm long	✓
AC006	15 mm Ø x 150 mm long	✓
AC007A	Legacy ball joint	✓
AC007B	Contemporary	✓
AC007C	Mitred	✓
AC007D	Flexi (suitable for use with standard element only)	✓
AC007E	Variheat (suitable for use with variheat element only)	✓
AC007F	Originals ball joint	✓
AC007G	Electronique (suitable for use with electronique element only)	✓
AC007H	Hexagonal	✓
AC035	Oil Aroma Blanking Plug	✓
AC040	Heat Sensor Element Cover Shroud	✓
AC060	Air Vent Cap	✓



AC012 Voltage Regulator

A manual controller to manage power consumption to your towel warmer.



AC013 7 Day Timer

This digital controller gives you the facility to pre plan when you will need your towel rail on and off.



AC014 Pattress Plate

Housing the wires from the towel rail element if no external controller is required.



AC034

Towel Bar for CN027



AC023

Clip on chrome towel bar in three widths.



AC030

Magnetic towel bar.



AC032

Stainless steel towel bar.

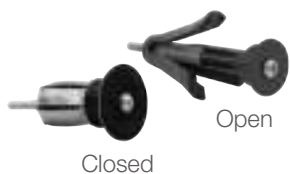

AC037

Pack of 2 Heavy Duty Hollow Wall Fixings



AC031

Clip on frosted sphere and chrome robe hook.

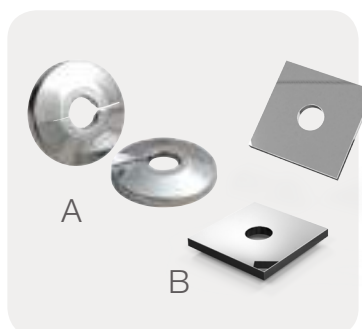

AC010

Round or square metal cover plates.



AC011

Arne straight or angled fixing kit.



AC011F

Crosshead angled fixing kit.

AC011A & AC011B ARE AVAILABLE IN OUR CONTEMPORARY COLOUR FINISHES.

Product	Description	Stock or made to order
2		
AC010A	Round 15 mm internal diameter hinged cover plates	✓
AC010B	Square 15 mm internal diameter cover plates	✓
AC011A & AC011B	VL003 (pair) straight or angled valves with cover plates and connection tubes	✓
AC011F	VL008 (pair) angled valves with cover plates and connection tubes	✓
AC012	Chrome 75W - 400W (1 gang)	✓
AC012	Chrome 150W - 1000W (2 gang)	✓
AC013	Digital single channel programme timer (White)	✓
AC014	Covers 1 gang pattress box (Chrome)	✓
AC023A	Chrome 220 mm wide, suitable for MD001, MD005 and MD034	✓
AC023B	Chrome 310 mm wide, suitable for MD001, MD005 and MD034	✓
AC023C	Chrome 405 mm wide, suitable for MD001, MD005 and MD034	✓
AC030	Chrome 443 mm wide, suitable for MD056	✓
AC031	Chrome and frosted sphere. Suitable for MD001, MD003, MD005 and MD034	✓
AC032	Stainless steel 450 mm wide, suitable for DR003 and DR021	✓
AC034A	Towel Bar for CN027 - 60mm wide x 200mm wide Chrome, White or Anthracite	✓
AC034B	Towel Bar for CN027 - 60mm wide x 340mm wide Chrome, White or Anthracite	✓
AC034C	Towel Bar for CN027 - 60mm wide x 480mm wide Chrome, White or Anthracite	✓
AC037	Pack of 2 Heavy Duty Fixings	✓

VALVES



Arne VL003

A modern valve that works with many designs.



Arne Thermostatic VL004

Controlling the heat of your towel rail or radiator.



Xero VL012

This modern tap head style suits many bathroom taps and fittings.

Available in our contemporary colour finishes.



Piazza VL014

This cubed valve gives a great finish to our square tube products.



Combination Kit VL013

A combination kit of VL003 straight and angles valves for dual energy option, applicable for all multirail products.



Adapta VL001

A contemporary double angled valve, almost not to be noticed.

Dual Fuel Valves VL015

For both central heating and electric dual fuel options.



*Arne VL003 valves are available in Chrome as standard or one of our Contemporary Colours as an option for the same price.

Valve	Description	Type	Stock or made to order
2			
Arne VL003	1/2" BSP X 15 mm	Straight	✓
Arne VL003	1/2" BSP X 15 mm	Angled	✓
Arne Thermostatic VL004	1/2" BSP X 15 mm thermostatic	Straight	✓
Arne Thermostatic VL004	1/2" BSP X 15 mm thermostatic	Angled	✓
Art Deco VL006	1/2" BSP X 15 mm	Angled	✓
Adapta VL001	1/2" BSP X 15 mm	Angled	✓
Crosshead VL008	1/2" BSP X 15 mm	Straight	✓
Crosshead VL008	1/2" BSP X 15 mm	Angled	✓
Excelsior VL010	1/2" BSP X 15 mm thermostatic	Angled	✓
Xero VL012	1/2" BSP X 15 mm	Angled	✓
Piazza VL014	1/2" BSP X 15 mm	Angled	✓
Crosshead 2 VL018	1/2" BSP X 15 mm	Angled	✓
Combination Kit VL013	1/2" BSP X 15 mm	Angled / Straight	✓
Dual Fuel VL015	1/2" BSP X 15 mm	Angled	✓
Arne Corner VL023	1/2" BSP X 15 mm	Corner	✓
Arne Corner Thermostatic VL024	1/2" BSP X 15 mm thermostatic	Corner	✓



Art Deco VL006

These valves work well with the hexagonal tube deco designs.



Crosshead VL008

A valve that suits most traditional designs. Our benchmark.



Crosshead 2 VL018

A capstan style valve, which suits ball jointed products.



Excelsior VL010

Thermostatic, a substantial valve in a time honoured design.



Arne Corner VL023

A discreet contemporary valve that neatly aligns with your towel warmer.



Arne Corner Thermostatic VL024

Thermostatic version of our discreet corner valves.

Valves are supplied as standard in a chrome finish. Other finishes are available.

Please Note: Designs may differ slightly when ordering in different finishes.

Please contact our sales office on 01902 387000 to discuss your requirements.



Straight Valves



Angled Valves

COLOURS

Vogue UK Radiator Colours and finishes

The colours and finishes below are available on many of our ranges carrying the RAL colour symbol. The featured colours have a £224 supplement ex VAT on the white price. Other RAL colours are available POA.

New for 2019



Silver crackle



Copper crackle



Bronze crackle

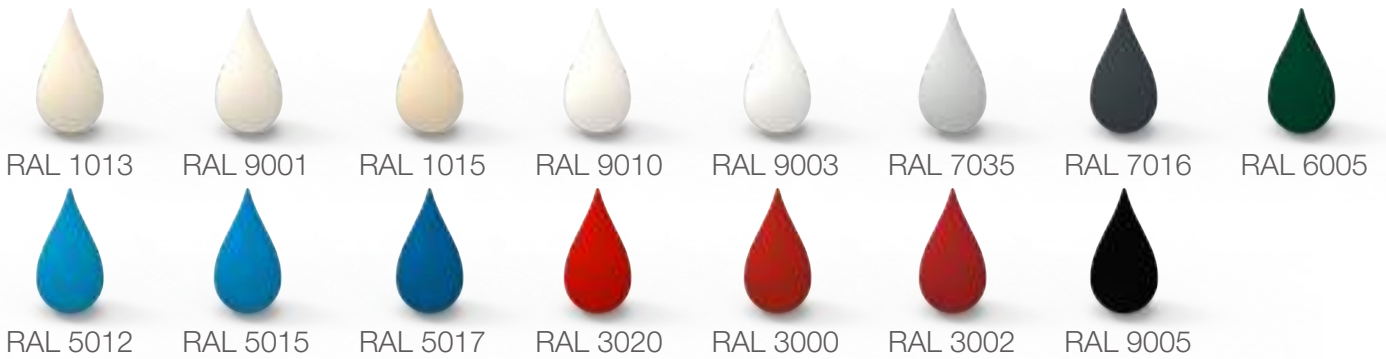

Vogue UK Radiator Colours - POA



RAL colours come in a gloss finish as standard, unless specified differently.

The RAL colours in this chart have been matched as closely as possible. The colour depends on the printing or your monitor. We suggest the official RAL colour chart gives the most accurate colour sample.

Vogue UK Contemporary Colour Range

New for 2019



White Sparkle

New for 2019



Grey Sparkle

New for 2019



Matt Black



Espresso



Anthracite



Satin Black



Latte



Cappuccino



Mocha

The contemporary colour range is available as a stocked item in three models Serene, Vela and Focus. White & Grey Sparkle, Latte, Cappuccino, Mocha and Anthracite have a textured finish, with Espresso and Satin Black being gloss. These finishes are also available on other ranges.

Vogue UK Metallic Finishes



Matt Gold



Antique Gold



Dark Gold



*Polished Brass
Same price as
Polished Chrome



*Brushed Brass
Same price as
Polished Chrome



Melange



Polished Chrome



Brushed Chrome



Bright Nickel



Brushed Nickel



Polished Stainless



Brushed Stainless



Antique Brass



Antique Bronze



Antique Copper



Pewter
£ Chrome + 35%



The Vogue Rose Gold
£ POA



The Vogue Brushed
Rose Gold
£ POA



*Polished Copper tube
£ POA

***Please note:** Polished Brass, Brushed Brass and Polished Copper tube finishes, are supplied in a raw, un-lacquered finish, as standard. This un-lacquered (ie; unprotected) base material will discolour in a short period of time and will therefore require regular cleaning in order to maintain the finish. To add a lacquer to preserve the finish, add an additional 20% to the un-lacquered price.

Antique Bronze, Oil Rubbed Bronze & Antique Copper - Due to the reaction between the bronze solution with the base metal there will always be a degree of natural variation in shading between different components.

Inset Radiator Range



Column



Convactor



Flat Panel

JOINTS & TUBING

Selecting your joint and tube design could not be more flexible.
Our hand made selection of towel rails can be as individual as you are.

Vogue UK Tubing Range

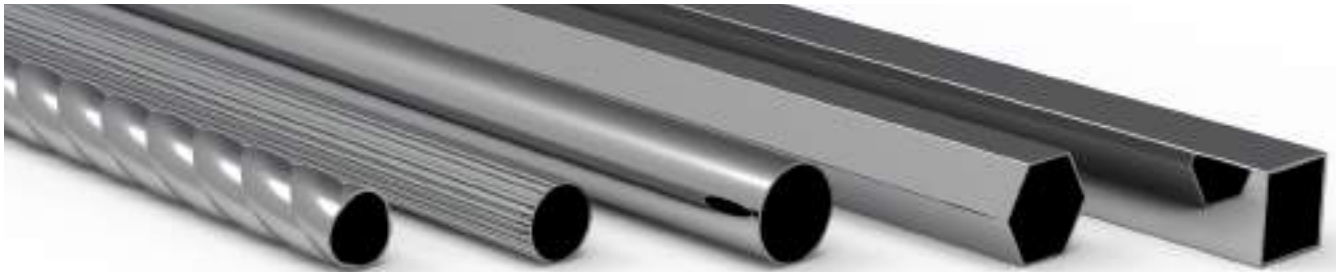

Rope

Reed

Plain

Hexagonal

Square

Vogue UK Joint Range



Ball Joint 1"

Legacy Ball Joint 1.25"

Originals Ball Joint

Charlotte Ball Joint 1.5"

Grandeur Joint

The 1909 Ball Joint



Cylinder Joint



Art Moderne Corner



Minama Square Corner



Romolo Joint



Art Linea Joint



Mitred Corner



Plain Corner



Contemporary Corner



Minama Round Corner



Valour Bend

General terms & conditions

Bespoke items are non-returnable. Please note that certain non-stock models are also non-returnable, please confirm with our Sales Office on telephone +44(0) 1902 387000.

All heat outputs are shown at 50°CΔt, in compliance with BSEN442 - Specification for Radiators and Convectors. To convert to 60°CΔt, multiply heat output by conversion factor 1.268 (approximate figure), to convert to 70°CΔt, multiply heat output by conversion factor 1.549 (approximate figure).

All measurements given are nominal dimensions only (mm), and are not binding. Detailed technical drawings are available on request from our Sales Office on +44(0) 1902 387000 or via our website - www.vogueuk.co.uk

Manufactured from hot brass stamped fittings and high quality brass tube complying to BS2871.

Some models manufactured from high grade CR steel tubing and/or containing steel components suitable for closed/indirect circuits only. All rails are pressure tested to 100p.s.i (6.9 bar) air immersed in water. All models are fitted with 2 x 1/2" BSP F.I. connections. Alternative M.I. or compression fitting is available on request. 3/4" BSP connections available at extra cost on some models.

A manual bleed air vent is fitted to all hot water/dual fuel models. Auto air vents available on request at additional cost.

Pipe centres are provided as centre to centre tappings using the Vogue (UK) range of valves.

In compliance with our policy of constant improvement we reserve the right to alter specifications, materials and dimensions or discontinue any of our products without prior notice.

The colours in the brochure are as accurate as the colour printing processes allow. Photographs for illustrative purposes only. We reserve the right to change specifications without prior notification.

Vogue (UK) Ltd recommends that existing or new pipework is not adjusted until the towel warmer or radiator is installed in its final position.

Products ordered incorrectly or where the specification has changed may incur a re-stock charge. Bespoke/custom made products are non-refundable. Upon the return of a product Vogue (UK) Ltd reserve the right to refuse credit if the product is not made available upon an agreed collection/return in line with the Company's terms and conditions.

A copy of the Company's full Terms and Conditions of Trading is available on request.

Continual Improvement

Our company policy is one of continual improvement and Vogue (UK) Ltd reserves the right to amend designs, specification or discontinue any of our products without prior notice. E & OE

Valves are NOT supplied with each product. Please see Valves & Accessories section for further details.

Tiles provided by British Ceramic Tile Ltd
www.britishceramictile.com

Guarantee

Vogue (UK) Ltd is a company that celebrates the wealth of traditional, quality handcrafted heated towel rails and radiators and is one of the last true manufacturers in the UK. Vogue branded towel rails installed within the UK are also covered by an extended 2, 15 or 30 Year Guarantee – subject to Terms & Conditions of guarantee against manufacturing defects. Components such as inset radiators, not of our manufacture, which become faulty by reason of defected materials, come with a 2 year guarantee only.



EN442.1 & 2

Where applicable product within this publication has undergone independent testing to verify heat outputs are in accordance with the parameters laid down in the above European standards. Some products at the time of print may be awaiting confirmation

Construction Product Regulations (CPR)

In compliance with the above, Vogue UK LTD (The company) holds declaration of Performance Certificates (DoPs) for all products covered by the Harmonised Standard EN442.1 / 2. Copies of relevant certificates are available on request.

Product with a declared heat output of 200Watt or less 50 degree C Delta T are not classified by The company as heating appliances and are therefore not covered by the above. All individually manufactured bespoke products are similarly exempted from the above legislation

ISO 9001:2008 certified

Vogue (UK) is proud to be ISO 9001: 2008 certified. Quality is utmost in importance to our organization, in both the products and services we provide our customers. Reflecting this commitment, Vogue (UK) implemented and received certification of our Quality Management System in accordance with ISO 9001:2008.

General

Carriage - Paid UK mainland, excluding requests for next day service, Export carriage can also be arranged. Please contact our Sales Office for details on telephone +44(0) 1902 387000.

All images are for illustration purposes only.

Model	Code	Material	Section	Style	Installation	Page
Pure	MD037	BR	CN	MTW	WM	16
Q						
Quadrate	MD074	MS	CN	MTW	WM	26
Quadrate Harmonique	MD078	MS	CN	RTW	WM	27
R						
Regency	LG004/OG006	MS/BR	TR	TTW	FW	80
Regency	LG005/OG015	MS/BR	TR	TTW	WM	84
Regency II	LG036/OG009	MS/BR	TR	TTW	WM	81
Regency Tall	LG013/OG007	MS/BR	TR	TTW	FW/WM	85
Rubik	MD038	SS	CN	MTW	WM	28
S						
Sequel III	TM005	BR	TR	RTW	WM	105
Sequel V	TM006	BR	TR	RTW	WM	104
Serenade	DR008	MS	DR	FR	WM	117
Serene	MD049	MS	CN	MR	WM	30
Sesto Rondo III	MD021	BR	CN	MR	WM	56
Shower Curtain Rails	SCR1 - 6	BR	TR		WM	108
Simplicity II	EL040/EL045	SS	E	VT	WM	135
Simplicity IV	IVCN026	BR	CN	TTW	WM	47
Smooth	CN035	MS	CN	MTW	WM	18
Smooth II	CN036	MS	CN	MTW	WM	19
Solo	TR001	BR/MS	CN	S	WM	49
Squire	MD047	MS	CN	MR	WM	29
Squire Vertical	DR005	MS	DR	DR	WM	116
Stella	MD034	SS	LR	MR	WM	76
Stromboli	ER002	MS	E	ER	WM	131
Studio	MD006	BR	LR	MR	WM	77
Suave	MD056	MS	DR	FR	WM	113
T						
Tempo	MD072	MS	CN	MR	WM	57
Tune	MD003	MS	LR	MR	WM	74
U						
Unique	CN028	MS	CN	MTW	WM	42
V						
Valves	VL		A	VL		148
Vela	MD048	MS	CN	MR	WM	39
Venture	CN022	BR	CN	TTW	WM	43
Vintage	LG010B	BR	TR	TTW	WM	101
Vision	DR022	MS	DR	DR/VT	WM	114
Vista	IN002	SS	CN	MTW	WM	24
Vivid	CN021	BR	CN	TTW	WM	44
Vivid IV	IVCN021	BR	CN	TTW	WM	45
Vivid IV Horizontal	IVCN021	BR	CN	TTW	WM	46
Z						
Zenith	IN007	SS	CN	MTW	WM	22

Innovation

Vogue UK is a vibrant organisation with research being conducted in many technology disciplines. This research results in exciting products as evidenced throughout the design collections we offer. Vogue UK has set itself a clear objective: both through consistent preservation and long tradition of British craftsmanship and meeting its high standards, as well as creating, with its very own innovative heating developments, contemporary design and a heightened passion for detail and perfection.

Those who appreciate lasting value derived from the synergy of traditional craftsmanship, creative development and the latest technology, as well as dedication in seeking the extraordinary know not to entrust any towel rail design but rather to a design crafted from Vogue (UK).

Vogue UK emphasises its creative drive to differentiate its towel rail designs down to the finest detail and its desire to monitor, to the greatest possible extent, the development and manufacture of a hand crafted product. We use the latest technology to produce low-volume individual parts with high added value continuously offering home interiors and connoisseurs of design new, impressive towel rail models.

Environment

Vogue UK has a legacy of core values, rooted strongly in safety, health and environmental stewardship. For 28 years, we have been reducing the environmental footprint of our own operations. Today, footprint reduction is expected of all companies. The challenge – and the opportunity – are products and manufacturing processes that are safer, less toxic, more energy efficient, use less water, less energy, and produce fewer greenhouse gases. Running our company in an environmentally friendly way is good for the environment and good for our business. We're working to conserve energy and reduce waste and are exploring the use of sustainable materials and products. Whether we're saving costs by reducing energy consumption or creating covetable products through innovative, sustainable design, we believe that reducing our impact on the environment can also result in positive business benefits.

INDEX KEY

Material	Section	Style		Installation
BR Brass	CN Contemporary	C Column radiator	MTW Modern towel warmer	FM Floor Mounted
MS Mild Steel	LR Ladder Rails	DR Designer radiator	RTW Radiator towel warmer	WM Wall Mounted
SS Stainless Steel	TR Traditional	DTW Designer towel warmer	S Shelf	FW Floor and Wall Mounted
CI Cast Iron	DR Designer Radiators	ER Electric radiator	TTW Traditional towel warmer	
	E Electric	FR Flat Radiator	UFH Under floor heating	
	A Additions	MR Multirail	VT Vertical tube	



Vogue (UK) Ltd
Strawberry Lane
Willenhall, West Midlands
WV13 3RS United Kingdom

T: +44(0) 1902 387000 F: +44(0) 1902 387001
E: info@vogueuk.co.uk W: www.vogueuk.co.uk

Sales Office

T: +44(0) 1902 387020 F: +44(0) 1902 387021
E: sales@vogueuk.co.uk

